

UNCONTROLLED DOCUMENT

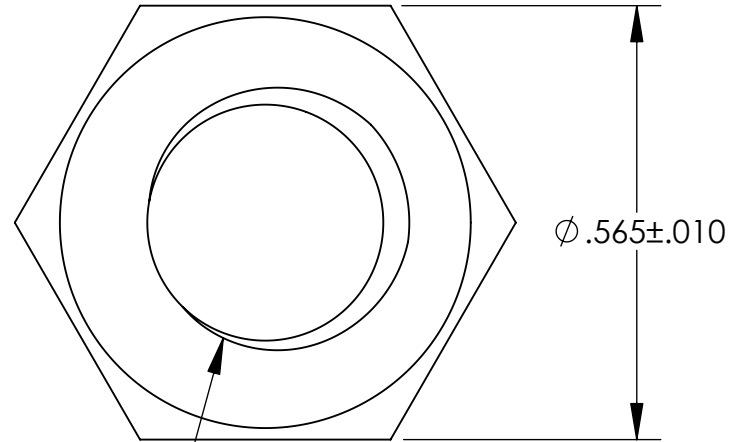
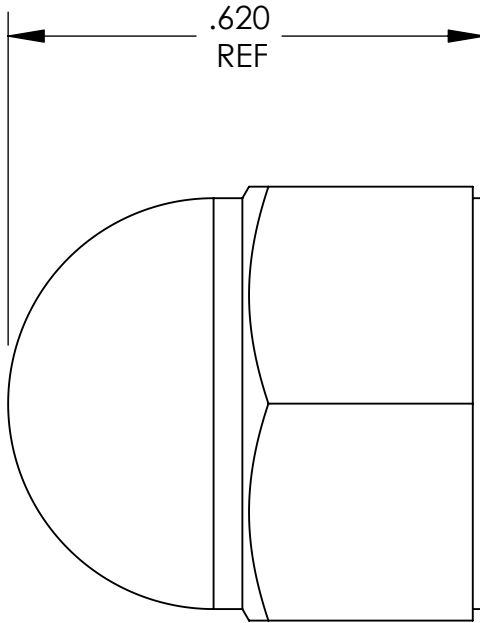

3/8"-16 THREADS

TOLERANCES UNLESS NOTED

- ±.005 ON DIMENSIONS THRU .625
- ±.008 ON DIMENSIONS .626 THRU 1.000
- ±.010 ON DIMENSIONS 1.001 THRU 1.500
- ±.015 ON DIMENSIONS LARGER THAN 1.500
- ±.015 ON FRACTIONAL DIMENSIONS

WE RESERVE THE RIGHT
TO DISCONTINUE ITEMS,
CHANGE SPECIFICATIONS
OR DESIGN AT ANY TIME
WITHOUT NOTICE AND
WITHOUT INCURRING
ANY OBLIGATIONS

PROPERTY OF
MICRO PLASTICS INC.

CATALOG DRAWING
NYLON CAP NUTS
MICRO P/N 0537516CN
DWG. # 0537516CN
FILE SERVER\ENG\WEB

MATERIAL: NYLON 6/6

DATE

SCALE
4:1

SD