

XCKD2110P16

Limit switch, Limit switches XC Standard, XCKD, metal end plunger, 1NC+1 NO, snap, M16



Main

Range of Product	Telemecanique Limit switches XC Standard
Series name	Standard format
Product or Component Type	Limit switch
Device short name	XCKD
Sensor design	Compact form B CENELEC EN 50047
Body type	Fixed
Head type	Plunger head
Material	Metal
Body Material	Zamak
Head material	Zamak
Fixing Mode	By the body
Movement of operating head	Linear
Type of operator	Spring return plunger metal
Type of approach	Vertical approach, 1 direction
Number of poles	2
Contacts type and composition	1 NC + 1 NO
Contact operation	Snap action

Complementary

Switch actuation	On end
Electrical connection	Screw-clamp terminals 1 x 0.34...2 x 1.5 mm ²
Cable entry	1 entry tapped for M16 x 1.5 cable gland 0.16...0.31 in (4...8 mm)
Contacts insulation form	Zb
Positive opening	With
Positive opening minimum force	45 N
Minimum force for tripping	15 N
Minimum actuation speed	0.01 m/min
Maximum actuation speed	1.64 ft/s (0.5 m/s)
Repeat accuracy	0.1 mm on the tripping points with 1 million operating cycles
Contact code designation	A300, AC-15 (Ue = 240 V), Ie = 3 A 10 A EN 60947-5-1 A300, AC-15 (Ue = 240 V), Ie = 3 A 10 A IEC 60947-5-1 appendix A Q300, DC-13 (Ue = 250 V), Ie = 0.27 A EN 60947-5-1 Q300, DC-13 (Ue = 250 V), Ie = 0.27 A IEC 60947-5-1 appendix A
[Ui] rated insulation voltage	300 VUL 508 500 V 3)IEC 60947-1 300 VCSA C22.2 No 14
Maximum resistance across terminals	25 MOhm IEC 60255-7 category 3
[Uimp] rated impulse withstand voltage	6 kV IEC 60664 6 kV IEC 60947-1
Short-circuit protection	10 A cartridge fuse gG
Electrical durability	5000000 Cycles, DC-13, 120 V, 4 W 60 cyc/mn 0.5, DC IEC 60947-5-1 appendix C 5000000 Cycles, DC-13, 24 V, 10 W 60 cyc/mn 0.5, DC IEC 60947-5-1 appendix C 5000000 cycles, DC-13, 48 V, 7 W 60 cyc/mn 0.5, DC IEC 60947-5-1 appendix C
Mechanical durability	15000000 cycles
Width	1.22 in (31 mm)

Height	2.56 in (65 mm)
Depth	1.18 in (30 mm)
Net Weight	0.40 lb(US) (0.18 kg)
Terminals description ISO n°1	(21-22)NC (13-14)NO

Environment

Shock resistance	50 gn 11 ms IEC 60068-2-27
Vibration resistance	25 gn 10...500 Hz IEC 60068-2-6
IP degree of protection	IP66IEC 60529 IP67IEC 60529
IK degree of protection	IK06 EN 50102
Electrical shock protection class	Class I IEC 61140 Class I NF C 20-030
Ambient air temperature for operation	-13...158 °F (-25...70 °C)
Ambient Air Temperature for Storage	-40...158 °F (-40...70 °C)
Protective treatment	TC
Product Certifications	CCC UL CSA
Standards	IEC 60947-5-1 EN 60947-5-1 CSA C22.2 No 14 IEC 60204-1 EN 60204-1 UL 508



Ordering and shipping details

Category	22418 - LIMIT SWITCH,IEC,XCKP&XCKT
Discount Schedule	T
GTIN	3389110196863
Nbr. of units in pkg.	1
Package weight(Lbs)	5.75 oz (163 g)
Returnability	No
Country of origin	FR

Packing Units

Unit Type of Package 1	PCE
Package 1 Height	1.65 in (4.2 cm)
Package 1 width	1.65 in (4.2 cm)
Package 1 Length	3.07 in (7.8 cm)
Unit Type of Package 2	S01
Number of Units in Package 2	27
Package 2 Weight	10.07 lb(US) (4.566 kg)
Package 2 Height	5.91 in (15 cm)
Package 2 width	5.91 in (15 cm)
Package 2 Length	15.75 in (40 cm)

Offer Sustainability

Sustainable offer status	Green Premium product
California proposition 65	WARNING: This product can expose you to chemicals including: Diisononyl phthalate (DINP), which is known to the State of California to cause cancer, and Di-isodecyl phthalate (DIDP), which is known to the State of California to cause birth defects or other reproductive harm. For more information go to www.P65Warnings.ca.gov
REACH Regulation	 REACH Declaration
EU RoHS Directive	Pro-active compliance (Product out of EU RoHS legal scope)  EU RoHS Declaration
Mercury free	Yes

RoHS exemption information

 Yes

Environmental Disclosure

 [Product Environmental Profile](#)

Contractual warranty

Warranty

18 months

Dimensions

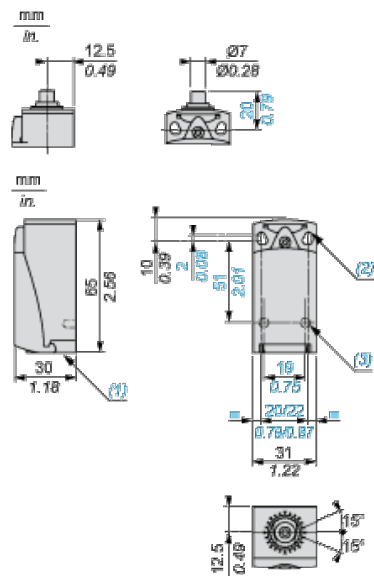

- (1) Tapped entry for M16 x 1.5
- (2) 2 elongated holes $\varnothing 4.3 \times 6.3$ mm on 22 mm centres, 2 holes $\varnothing 4.3$ on 20 mm centres.
- (3) 2 x $\varnothing 3$ holes for support studs, depth 4 mm.

Mounting with Cable Entry

Position of Cable Gland



- (1) Recommended
- (2) To be avoided

Setting-up

Plunger or Multi-directional Heads



Wiring Diagram

2-pole NC + NO Snap Action

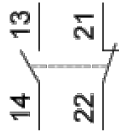

Characteristics of Actuation

Switch Actuation on End

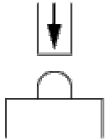

Functionnal Diagram

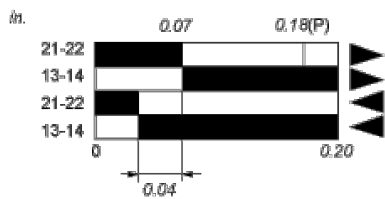
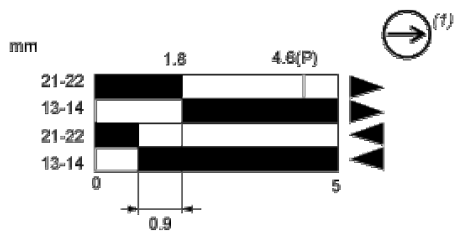

- (2)
- (3)
- ▶ (4)
- ◀ (5)

- (P) Positive opening point
- (1) NC contact with positive opening operation
- (2) Closed
- (3) Open
- (4) Tripping
- (5) Resetting