

FMS6418A

Triple Video Driver with Selectable HD/SD Video Filters for RGB or YUV Signals

Features

- Three video anti-aliasing or reconstruction filters
- YUV/RGB signal support
- 2:1 Mux inputs for multiple RGB/YUV inputs
- Selectable 8MHz or 30MHz 6th order filters for SD/HD applications
- DC coupled input, AC coupled output
- All outputs can drive AC coupled 150Ω loads and provide 6dB of gain
- 0.6% differential gain with 0.15° differential phase
- 36dB/octave roll-off on all channels

Applications

- Cable Set top boxes
- Satellite Set top boxes
- DVD players
- HDTV
- Personal Video Recorders (PVR)
- Video On Demand (VOD)

Description

The FMS6418A offers comprehensive filtering for set top box or DVD applications. This part consists of a triple 6th order filter with selectable 30MHz or 8.0MHz frequencies.

A 2-to-1 multiplexer is provided on each filter channel. The triple filters are intended for either YUV or RGB signals. All channels accept DC coupled ground-referenced 1V signals. The filters provide 2V_{pp} signals into AC coupled terminated loads. The low-pass filters are powered by 3.3V and the outputs by 5.0V.

The FMS6418A is available in both 16-pin SOIC and 14-pin TSSOP packages.

Functional Block Diagram

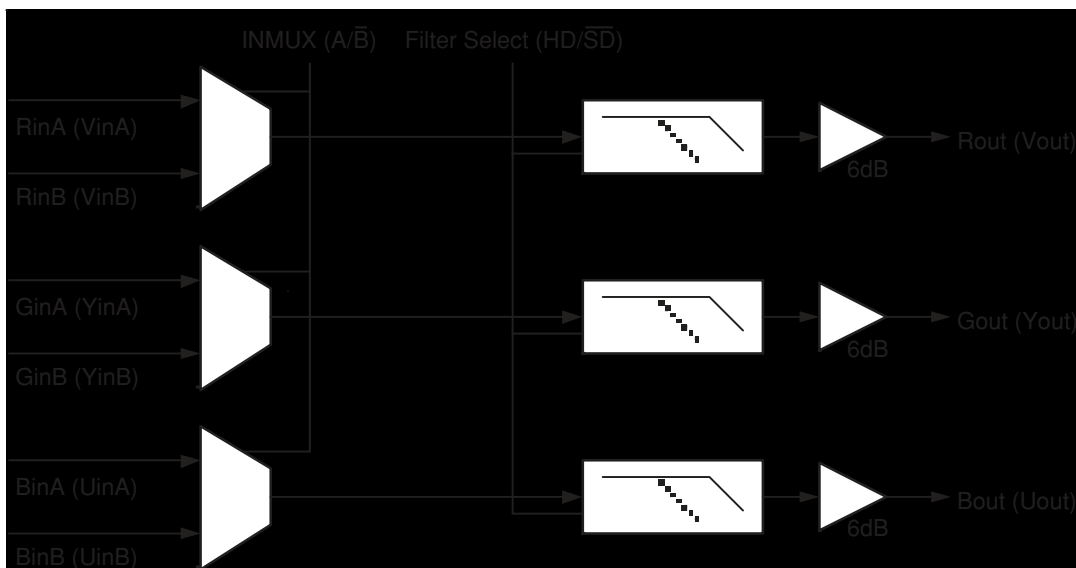

Electrical Specifications

($T_C = 25^\circ\text{C}$, $V_i = 1V_{pp}$; $V_{CCA} = 3.3V$, $V_{CCO} = 5.0V$, all inputs AC coupled with $0.1\mu\text{F}$, all outputs AC coupled with $220\mu\text{F}$ into 150Ω , referenced to 400kHz ; unless otherwise noted)

Symbol	Parameter	Conditions	Min	Typ	Max	Units
I_{CCA}	Supply Current ¹	V_{CCA} no load	35	45	70	mA
I_{CCO}	Supply Current ¹	V_{CCO} no load	30	45	60	mA
V_i	Input Voltage Max	Reference to ground		1.3		V
V_{il}	Digital Input Low ¹	F_{SEL} , IN_{MUX}	0		0.8	V
V_{ih}	Digital Input High ¹	F_{SEL} , IN_{MUX}	2.4		V_{CCO}	V
PSSR	PSSR (all channels)	DC		-40		dB

Standard Definition Electrical Specifications

($T_C = 25^\circ\text{C}$, $V_i = 1V_{pp}$; $V_{CCA} = 3.3V$, $V_{CCO} = 5.0V$, $F_{SEL} = 0$, all inputs DC coupled, all outputs AC coupled with $220\mu\text{F}$ into 150Ω , referenced to 400kHz ; unless otherwise noted)

Symbol	Parameter	Conditions	Min	Typ	Max	Units
AV_{RGBSD}	RGB SD Gain ¹	R,G,B channels SD Mode	5.6	6.0	6.4	dB
f_{1dBSD}	-1dB Bandwidth for SD ¹	R,G,B channels	4.5	6.0		MHz
f_{CSD}	-3dB Bandwidth for SD	R,G,B channels		8.2		MHz
f_{SBSD}	Attenuation: SD (stopband reject) ¹	R,G,B channels at $f = 27\text{MHz}$	-40	-55		dB
dG	Differential Gain	R,G,B channels		0.6		%
d ϕ	Differential Phase	R,G,B channels		0.15		°
THD	Output Distortion (all channels)	$V_{OUT} = 1.8V_{pp}$, RGB Out at 1MHz		0.4		%
X_{TALK}	Crosstalk (channel-to-channel)	at 1MHz		-70		dB
IN_{MUXISO}	IN_{MUX} Isolation	at 1MHz		-90		dB
SNR	Signal-to-Noise Ratio	R,G,B channels, NTC-7 weighting 4.2MHz lowpass, 100kHz highpass		-73		dB
t_{pdSD}	Prop Delay for SD	Delay from input to output at 4.5MHz		70		ns

High Definition Electrical Specifications

($T_C = 25^\circ\text{C}$, $V_i = 1V_{pp}$; $V_{CCA} = 3.3V$, $V_{CCO} = 5.0V$, $F_{SEL} = 1$, all inputs DC coupled, all outputs AC coupled with $220\mu\text{F}$ into 150Ω , referenced to 400kHz ; unless otherwise noted)

Symbol	Parameter	Conditions	Min	Typ	Max	Units
AV_{RGBHD}	RGB HD Gain ¹	R,G,B channels HD Mode	5.6	6.0	6.4	dB
f_{1dBHD}	-1dB Bandwidth for HD ¹	R,G,B channels	20	23		MHz
f_{CHD}	-3dB Bandwidth for HD	R,G,B channels		32		MHz
f_{SBHD}	Attenuation: HD (stopband reject) ¹	R,G,B channels at $f = 74.25\text{MHz}$	-30	-36		dB
X_{TALKB}	Crosstalk (channel-to-channel)	at 1MHz		-70		dB
IN_{MUXISO}	IN_{MUX} Isolation	at 1MHz		-90		dB
SNR	Signal-to-Noise Ratio	R,G,B channels		-73		dB
t_{pdHD}	Prop Delay for HD	Delay from input to output at 20MHz		20		ns

Notes:

- 100% tested at 25°C .

Absolute Maximum Ratings (beyond which the device may be damaged)

Parameter	Min	Max	Units
DC Supply Voltage	-0.3	6.5	V
Analog and Digital I/O	-0.3	$V_{CCO} + 0.3$	V
Output Current Any One Channel (Do Not Exceed)		120	mA

Note

Functional operation under any of these conditions is NOT implied. Performance and reliability are guaranteed only if operating conditions are not exceeded.

Reliability Information

Parameter	Min	Typ	Max	Units
Junction Temperature			+150	°C
Storage Temperature Range	-65		+150	°C
Lead Temperature (Soldering, 10s)			+300	°C
Thermal Resistance (θ_{JA}), JEDEC Standard Multi-layer Test Boards, Still Air		70		°C/W

Recommended Operating Conditions

Parameter	Min	Typ	Max	Units
Operating Temperature Range	0		70	°C
V_{CCO} Range	4.75	5.0	5.25	V
V_{CCA} Range	3.135	3.3	3.465	V

Standard Definition Typical Performance Characteristics

($T_C = 25^\circ\text{C}$, $V_i = 1V_{pp}$; $V_{CCA} = 3.3V$, $V_{CCO} = 5.0V$, $F_{SEL} = 0$, all inputs AC coupled with $0.1\mu\text{F}$, all outputs AC coupled with $220\mu\text{F}$ into 150Ω , referenced to 400kHz ; unless otherwise noted)

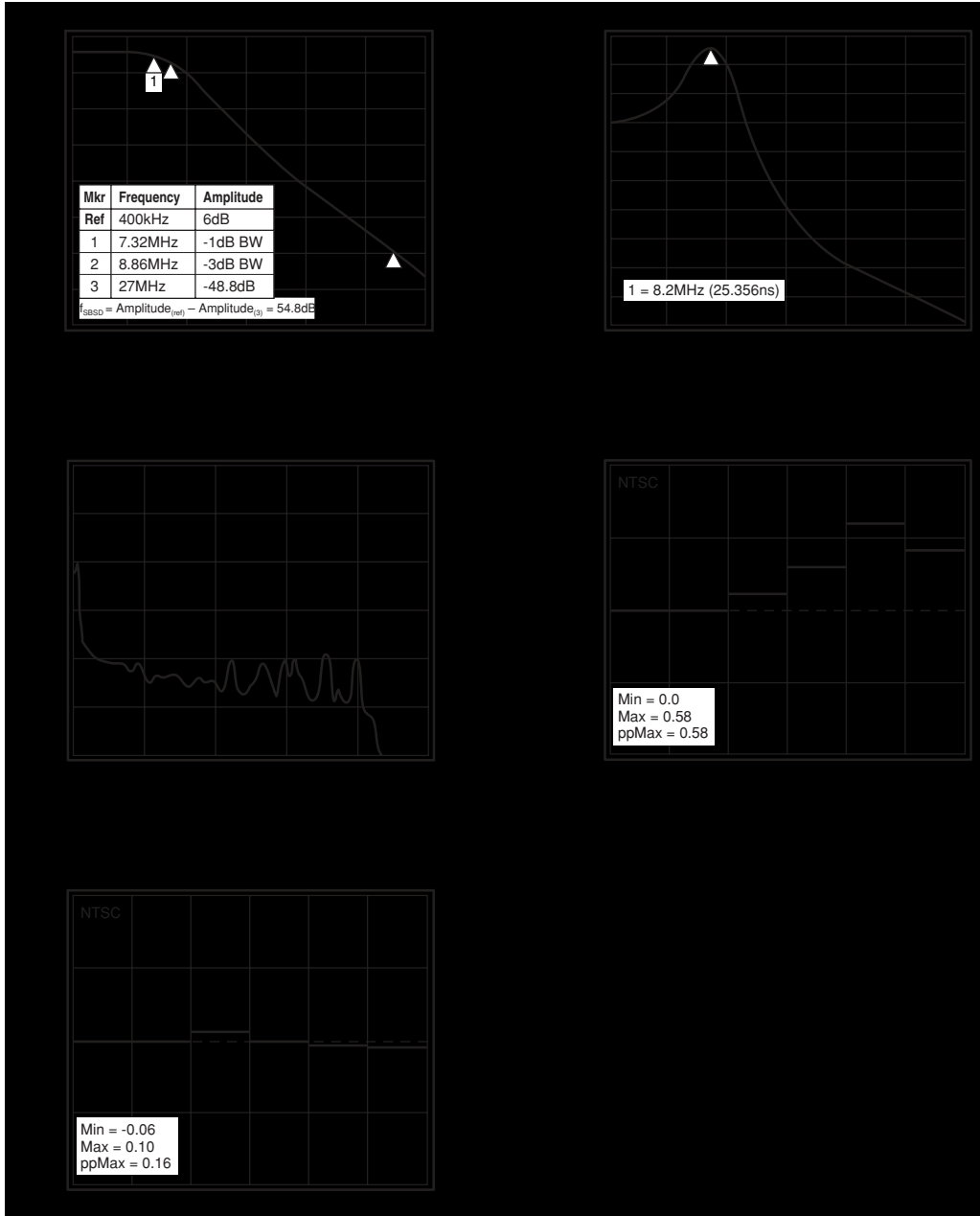

High Definition Typical Performance Characteristics

($T_C = 25^\circ\text{C}$, $V_i = 1V_{pp}$; $V_{CCA} = 3.3V$, $V_{CCO} = 5.0V$, $F_{SEL} = 1$, all inputs AC coupled with $0.1\mu\text{F}$, all outputs AC coupled with $220\mu\text{F}$ into 150Ω , referenced to 400kHz ; unless otherwise noted)

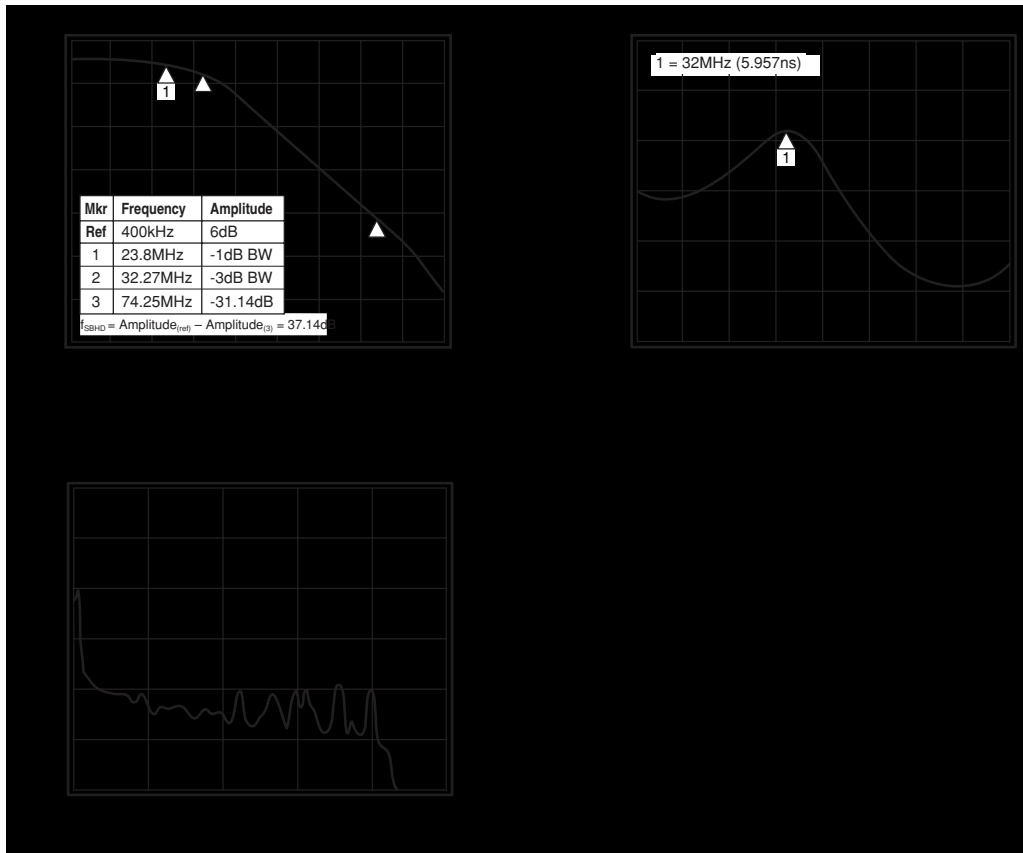

General Description

The FMS6418A offers comprehensive filtering for set top box or DVD applications. This part consists of a triple 6th order filter with selectable 30MHz to 8.0MHz frequencies. A 2-to-1 multiplexer is provided on each filter. The filters are intended for either YUV or RGB signals. All channels accept DC coupled ground-referenced 1V signals. The filters provide 2Vpp signals into AC coupled terminated loads. All channels provide 6dB gain, accept 1V ground referenced inputs, and drive AC coupled loads. The RGB low-pass filters are powered by 3.3V and the output buffers are powered by 5.0V.

The FMS6418A is a next generation filter solution from Fairchild Semiconductor addressing the expanding filtering needs for set top boxes, and DVD players. The product provides selectable filtering with cutoff frequencies of 30MHz or 8.0MHz on the RGB/YUV channels. Thus, the FMS6418A addresses the requirement for a single set top box to be compatible with a variety of resolution standards. Multiplexers on the RGB channels provide further flexibility. For DVD, Set-top Box, and TV applications, the product provides filtering and output drive amplification for three channels of outputs (RGB/YUV).

Applications

DC Levels

At any given time, the input signal's DC levels must be between 0.0V and 1.3V to utilize the optimal headroom and to avoid clipping on the outputs.

Single Supply +5V Operation

For low power consumption, the FMS6418 was designed to operate off of 5V and 3.3V. V_{CCA} can be operated from 5V instead of 3.3V and still meet specifications, except power consumption. When the 3.3V supply is increased to 5V, the typical current consumption increases by 5mA. The net effect is the part dissipates an additional 22 percent of power.

Driving the Digital Pins with 3.3V or 5V Logic.

Either is allowed as long as the V_{ih} and V_{il} are adhered to.

Pin Configurations

N _{MUX}	1	16	F _{SEL}
R _{INA}	2	15	V _{SSA}
R _{INB}	3	14	V _{SSO}
G _{INA}	4	13	R _{OUT}
G _{INB}	5	12	G _{OUT}
B _{INA}	6	11	B _{OUT}
B _{INB}	7	10	V _{CCO}
NC	8	9	V _{CCA}

N _{MUX}	1	14	F _{SEL}
R _{INA}	2	13	V _{SS}
R _{INB}	3	12	R _{OUT}
G _{INA}	4	11	G _{OUT}
G _{INB}	5	10	B _{OUT}
B _{INA}	6	9	V _{CCO}
B _{INB}	7	8	V _{CCA}

Typical Application Diagrams

TSSOP-14

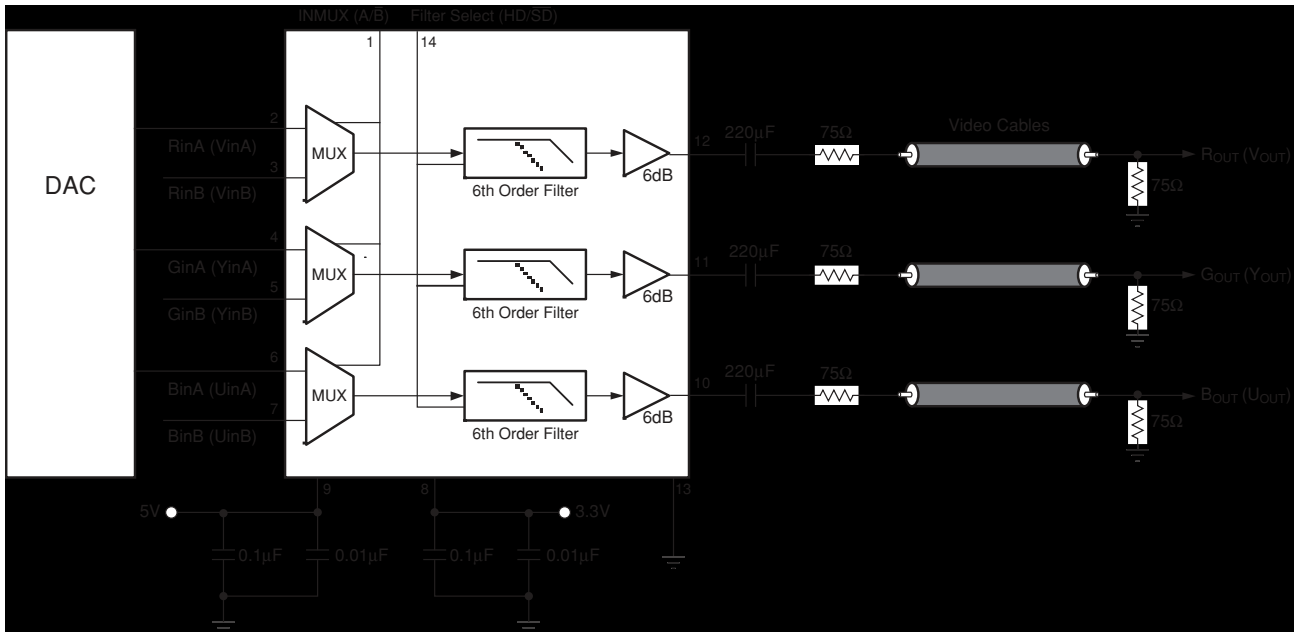

SOIC-16

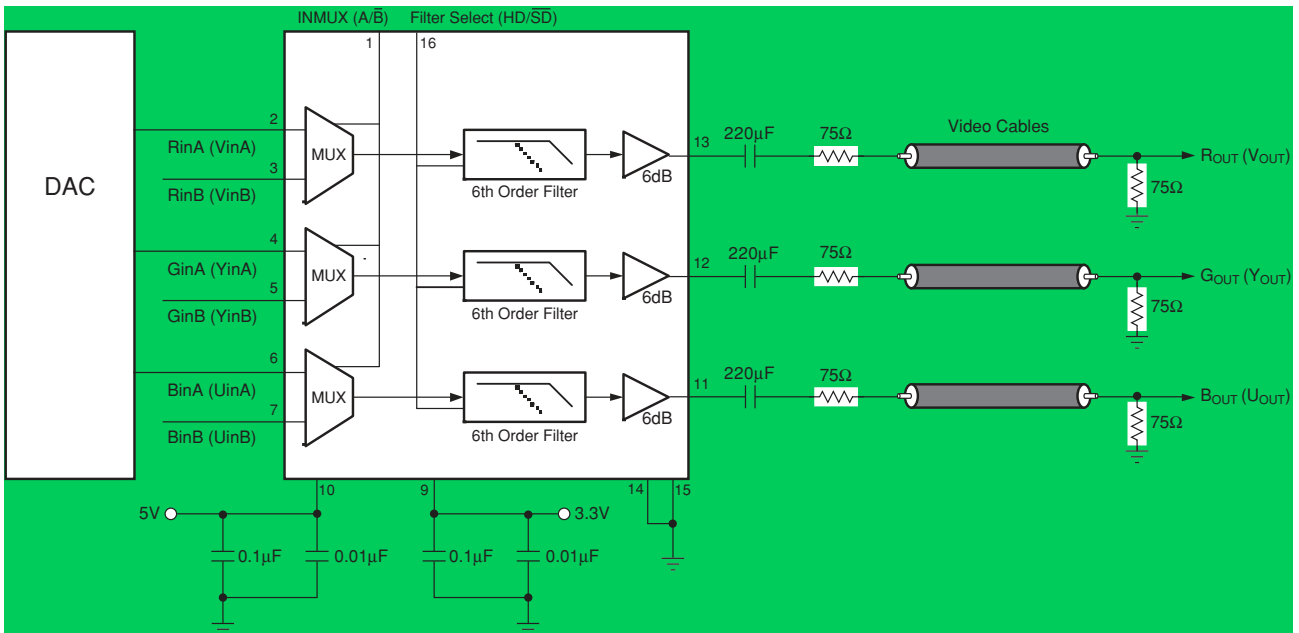

Pin Assignments

TSSOP-14	SOIC-16	Pin Name	Description	Equivalent Circuit
1	1	IN _{MUX}	Logic input selects between channel <A> or of the RGB inputs. (1): RGB A input, (0): RGB B input	
14	16	F _{SEL}	Logic Input selects between (0) SD (8.0MHz) and (1) HD (30.0MHz) filters	
2	2	R _{INA}	Analog RED video input - Channel A	
3	3	R _{INB}	Analog RED video input - Channel B	
4	4	G _{INA}	Analog GREEN video input - Channel A	
5	5	G _{INB}	Analog GREEN video input - Channel B	
6	6	B _{INA}	Analog BLUE video input - Channel A	
7	7	B _{INB}	Analog BLUE video input - Channel B	
N/A	8	NC	No Connect (float pin)	
8	9	V _{CCA}	+3.3V power supply for filters	
9	10	V _{CCO}	+5V power supply for output buffers	
10	11	B _{OUT}	Filtered Analog BLUE video output from either B _{INA} or B _{INB}	
11	12	G _{OUT}	Filtered Analog GREEN video output from either G _{INA} or G _{INB}	
12	13	R _{OUT}	Filtered Analog RED video output from either R _{INA} or R _{INB}	
N/A	14	V _{SSO}	Ground for output buffers	
N/A	15	V _{SSA}	Ground for filters	
13	N/A	V _{SS}	Ground	

⑪ = TSSOP-14 Pin Numbers

⑩ = SOIC-16 Pin Numbers

Package Dimensions

TSSOP-14

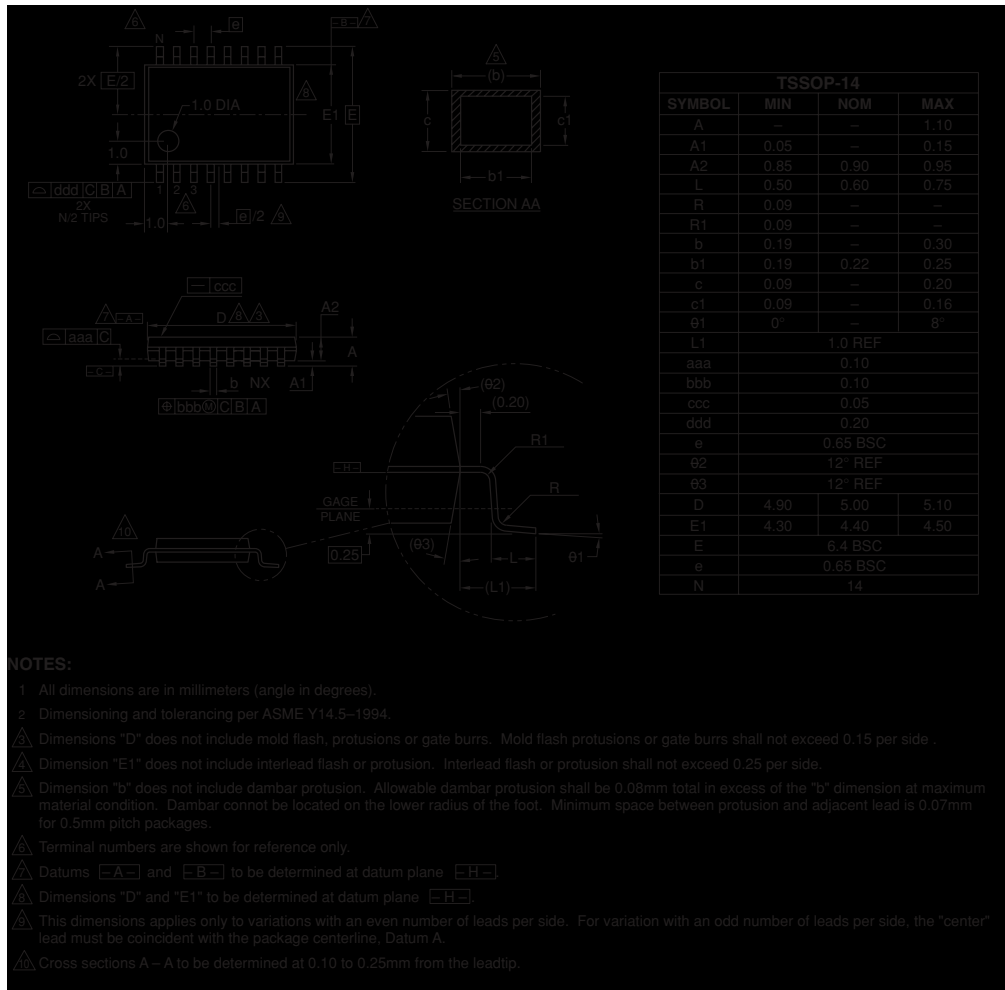

SOIC-16

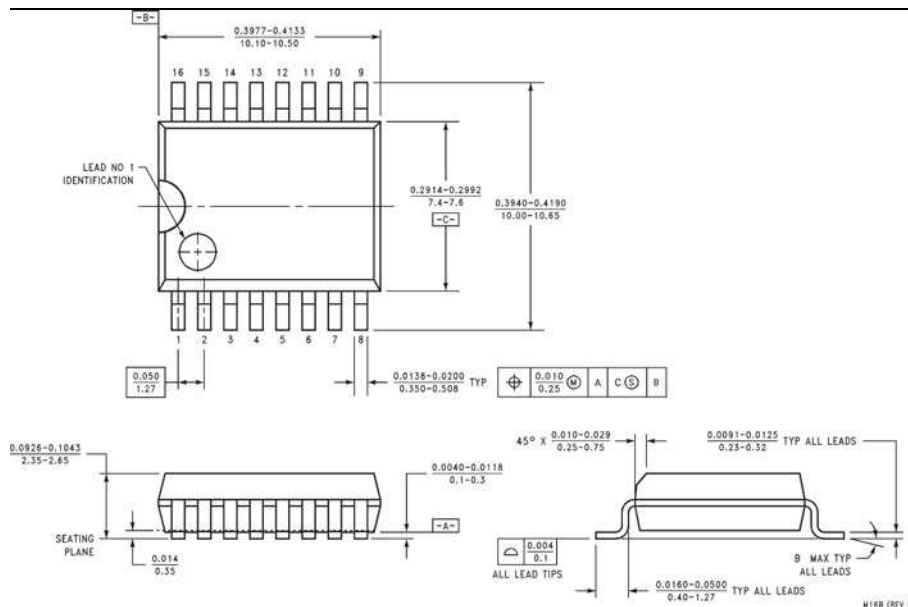

Ordering Information

Model	Part Number	Lead Free	Package	Container	Pack Qty
FMS6418A	FMS6418AMTC14		14-pin TSSOP	Tube	94
FMS6418A	FMS6418AMTC14X		14-pin TSSOP	Tape & Reel	2,500
FMS6418A	FMS6418AM16		16-pin SOIC	Tube	45
FMS6418A	FMS6418AM16X		16-pin SOIC	Tape & Reel	1,000

Temperature range for all parts: 0°C to +70°C.

DISCLAIMER

FAIRCHILD SEMICONDUCTOR RESERVES THE RIGHT TO MAKE CHANGES WITHOUT FURTHER NOTICES TO ANY PRODUCTS HEREIN TO IMPROVE RELIABILITY, FUNCTION OR DESIGN. FAIRCHILD DOES NOT ASSUME ANY LIABILITY ARISING OUT OF THE APPLICATION OR USE OF ANY PRODUCT OR CIRCUIT DESCRIBED HEREIN; NEITHER DOES IT CONVEY ANY LICENSE UNDER ITS PATENT RIGHTS, NOR THE RIGHTS OF OTHERS.

LIFE SUPPORT POLICY

FAIRCHILD'S PRODUCTS ARE NOT AUTHORIZED FOR USE AS CRITICAL COMPONENTS IN LIFE SUPPORT DEVICES OR SYSTEMS WITHOUT THE EXPRESS WRITTEN APPROVAL OF THE PRESIDENT OF FAIRCHILD SEMICONDUCTOR CORPORATION. As used herein:

1. Life support devices or systems are devices or systems which, (a) are intended for surgical implant into the body, or (b) support or sustain life, and (c) whose failure to perform when properly used in accordance with instructions for use provided in the labeling, can be reasonably expected to result in a significant injury of the user.
2. A critical component in any component of a life support device or system whose failure to perform can be reasonably expected to cause the failure of the life support device or system, or to affect its safety or effectiveness.