

LDO with Low I_{SUPPLY} , High PSRR

ISL9001A is a high performance Low Dropout linear regulator capable of sourcing 300mA current. It has a low standby current and high-PSRR and is stable with output capacitance of 1 μ F to 10 μ F with ESR of up to 200m Ω .

The ISL9001A has a very high PSRR of 90dB and output noise less than 30 μ V_{RMS}. A reference bypass pin allows connection of a noise-filtering capacitor for low-noise and high-PSRR applications. When coupled with a no load quiescent current of 25 μ A (typical), and 0.1 μ A shutdown current, the ISL9001A is an ideal choice for portable wireless equipment.

The ISL9001A provides a P_{GOOD} signal with delay time programmable through an external capacitor.

Several different fixed voltage outputs are standard. Output voltage options for each LDO range from 1.5V to 3.3V. Other output voltage options may be available upon request.

Pinout

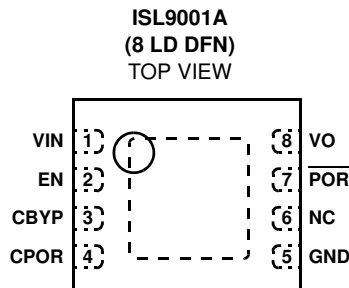

Features

- 300mA high performance LDO
- Excellent transient response to large current steps
- Excellent load regulation: <0.1% voltage change across full range of load current
- High PSRR: 90dB @ 1kHz
- Wide input voltage capability: 2.3V to 6.5V
- Extremely low quiescent current: 25 μ A
- Low dropout voltage: typically 200mV @ 300mA
- Low output noise: typically 30 μ V_{RMS} @ 100 μ A (1.5V)
- Stable with 1 μ F to 10 μ F ceramic capacitors
- Soft-start to limit input current surge during enable
- Current limit and overheat protection
- Delayed POR, programmable with external capacitor
- \pm 1.8% accuracy over all operating conditions
- Tiny 2mmx3mm 8 Ld DFN package
- -40°C to +85°C operating temperature range
- Pb-free (RoHS compliant)

Applications

- PDAs, cell phones and smart phones
- Portable instruments, MP3 players
- Handheld devices, including medical handhelds

ISL9001A

Ordering Information

| PART NUMBER (Notes 1, 2) | PART MARKING | VO VOLTAGE (V) (Note 3) | TEMP RANGE (°C) | PACKAGE Tape and Reel (Pb-free) | PKG. DWG. # |
|-----------------------------|--------------|----------------------------|--------------------|---------------------------------------|----------------|
| ISL9001AIRBZ-T | EBB | 1.5 | -40 to +85 | 8 Ld 2x3 DFN | L8.2x3 |
| ISL9001AIRCZ-T | EBC | 1.8 | -40 to +85 | 8 Ld 2x3 DFN | L8.2x3 |
| ISL9001AIRFZ-T | EBD | 2.5 | -40 to +85 | 8 Ld 2x3 DFN | L8.2x3 |
| ISL9001AIRRZ-T | EBK | 2.6 | -40 to +85 | 8 Ld 2x3 DFN | L8.2x3 |
| ISL9001AIRJZ-T | EBE | 2.8 | -40 to +85 | 8 Ld 2x3 DFN | L8.2x3 |
| ISL9001AIRKZ-T | EBF | 2.85 | -40 to +85 | 8 Ld 2x3 DFN | L8.2x3 |
| ISL9001AIRLZ-T | EBG | 2.9 | -40 to +85 | 8 Ld 2x3 DFN | L8.2x3 |
| ISL9001AIRMZ-T | EBH | 3.0 | -40 to +85 | 8 Ld 2x3 DFN | L8.2x3 |
| ISL9001AIRNZ-T | EBJ | 3.3 | -40 to +85 | 8 Ld 2x3 DFN | L8.2x3 |

NOTES:

1. These Intersil Pb-free plastic packaged products employ special Pb-free material sets; molding compounds/die attach materials and 100% matte tin plate PLUS ANNEAL - e3 termination finish, which is RoHS compliant and compatible with both SnPb and Pb-free soldering operations. Intersil Pb-free products are MSL classified at Pb-free peak reflow temperatures that meet or exceed the Pb-free requirements of IPC/JEDEC J STD-020.
2. Please refer to TB347 for details on reel specifications
3. For other output voltages, contact Intersil Marketing.

ISL9001A

Absolute Maximum Ratings

| | |
|----------------------------|----------------------|
| Supply Voltage (VIN) | +7.1V |
| VO Pin | +3.6V |
| All Other Pins | -0.3 to (VIN + 0.3)V |

Recommended Operating Conditions

| | |
|--------------------------------------|----------------|
| Ambient Temperature Range (TA) | -40°C to +85°C |
| Supply Voltage (VIN) | 2.3V to 6.5V |

Thermal Information

| | | |
|-----------------------------------|---|----------------------|
| Thermal Resistance (Notes 4, 5) | θ_{JA} (°C/W) | θ_{JC} (°C/W) |
| 8 Ld 2x3 DFN Package | 69 | 10 |
| Junction Temperature Range | -40°C to +125°C | |
| Operating Temperature Range | -40°C to +85°C | |
| Storage Temperature Range | -65°C to +150°C | |
| Pb-free reflow profile | see link below http://www.intersil.com/pbfree/Pb-FreeReflow.asp | |

CAUTION: Do not operate at or near the maximum ratings listed for extended periods of time. Exposure to such conditions may adversely impact product reliability and result in failures not covered by warranty.

NOTES:

- θ_{JA} is measured in free air with the component mounted on a high effective thermal conductivity test board with "direct attach" features. See Tech Brief TB379.
- For θ_{JC} , the "case temp" location is the center of the exposed metal pad on the package underside.

Electrical Specifications

Unless otherwise noted, all parameters are guaranteed over the operational supply voltage and temperature range of the device as follows: $T_A = -40^\circ\text{C}$ to $+85^\circ\text{C}$; $V_{IN} = (V_O + 0.5\text{V})$ to 5.5V with a minimum V_{IN} of 2.3V; $C_{IN} = 1\mu\text{F}$; $C_O = 1\mu\text{F}$.

| PARAMETER | SYMBOL | TEST CONDITIONS | MIN (Note 7) | TYP | MAX (Note 7) | UNITS |
|------------------------------|-----------|--|--------------|-----|--------------|---------------------|
| DC CHARACTERISTICS | | | | | | |
| Supply Voltage | V_{IN} | | 2.3 | | 6.5 | V |
| Ground Current | | Quiescent condition: $I_O = 0\mu\text{A}$ | | | | |
| | I_{DD} | LDO active | | 25 | 32 | μA |
| Shutdown Current | I_{DDS} | LDO disabled @ $+25^\circ\text{C}$ | | 0.1 | 1.0 | μA |
| UVLO Threshold | V_{UV+} | | 1.9 | 2.1 | 2.3 | V |
| | V_{UV-} | | 1.6 | 1.8 | 2.0 | V |
| Regulation Voltage Accuracy | | Initial accuracy at $V_{IN} = V_O + 0.5\text{V}$, $I_O = 10\text{mA}$, $T_J = +25^\circ\text{C}$ | -0.7 | | +0.7 | % |
| | | $V_{IN} = V_O + 0.5\text{V}$ to 5.5V, $I_O = 10\mu\text{A}$ to 300mA, $T_J = +25^\circ\text{C}$ | -0.8 | | +0.8 | % |
| | | $V_{IN} = V_O + 0.5\text{V}$ to 5.5V, $I_O = 10\mu\text{A}$ to 300mA, $T_J = -40^\circ\text{C}$ to $+125^\circ\text{C}$ | -1.8 | | +1.8 | % |
| Maximum Output Current | I_{MAX} | Continuous | 300 | | | mA |
| Internal Current Limit | I_{LIM} | | 350 | 475 | 600 | mA |
| Dropout Voltage (Note 6) | V_{DO1} | $I_O = 300\text{mA}$; $V_O < 2.5\text{V}$ | | 300 | 500 | mV |
| | V_{DO2} | $I_O = 300\text{mA}$; $2.5\text{V} \leq V_O \leq 2.8\text{V}$ | | 250 | 400 | mV |
| | V_{DO3} | $I_O = 300\text{mA}$; $V_O > 2.8\text{V}$ | | 200 | 325 | mV |
| Thermal Shutdown Temperature | T_{SD+} | | | 145 | | $^\circ\text{C}$ |
| | T_{SD-} | | | 110 | | $^\circ\text{C}$ |
| AC CHARACTERISTICS | | | | | | |
| Ripple Rejection | | $I_O = 10\text{mA}$, $V_{IN} = 2.8\text{V}$ (min), $V_O = 1.8\text{V}$, $C_{BYP} = 0.1\mu\text{F}$ | | | | |
| | | @ 1kHz | | 90 | | dB |
| | | @ 10kHz | | 70 | | dB |
| | | @ 100kHz | | 50 | | dB |
| Output Noise Voltage | | $I_O = 100\mu\text{A}$, $V_O = 1.5\text{V}$, $T_A = +25^\circ\text{C}$, $C_{BYP} = 0.1\mu\text{F}$ BW = 10Hz to 100kHz | | 30 | | μV_{RMS} |

ISL9001A

Electrical Specifications Unless otherwise noted, all parameters are guaranteed over the operational supply voltage and temperature range of the device as follows: $T_A = -40^{\circ}\text{C}$ to $+85^{\circ}\text{C}$; $V_{IN} = (V_O + 0.5\text{V})$ to 5.5V with a minimum V_{IN} of 2.3V ; $C_{IN} = 1\mu\text{F}$; $C_O = 1\mu\text{F}$. (Continued)

| PARAMETER | SYMBOL | TEST CONDITIONS | MIN (Note 7) | TYP | MAX (Note 7) | UNITS |
|---|------------------|--|--------------|-----|----------------|------------------------|
| DEVICE START-UP CHARACTERISTICS | | | | | | |
| Device Enable Time | t_{EN} | Time from assertion of the ENx pin to when the output voltage reaches 95% of the V_O (nom) | | 250 | 500 | μs |
| LDO Soft-Start Ramp Rate | t_{SSR} | Slope of linear portion of LDO output voltage ramp during start-up | | 30 | 60 | $\mu\text{s}/\text{V}$ |
| EN PIN CHARACTERISTICS | | | | | | |
| Input Low Voltage | V_{IL} | | -0.3 | | 0.5 | V |
| Input High Voltage | V_{IH} | | 1.4 | | $V_{IN} + 0.3$ | V |
| Input Leakage Current | I_{IL}, I_{IH} | | | | 0.1 | μA |
| Pin Capacitance | C_{PIN} | Informative | | 5 | | pF |
| POR PIN CHARACTERISTICS | | | | | | |
| $\overline{\text{POR}}$ Thresholds | V_{POR+} | As a percentage of nominal output voltage | 91 | 94 | 97 | % |
| | V_{POR-} | | 87 | 90 | 93 | % |
| $\overline{\text{POR}}$ Delay | t_{PLH} | $C_{POR} = 0.01\mu\text{F}$ | 100 | 200 | 300 | ms |
| | t_{PHL} | | | 25 | | μs |
| $\overline{\text{POR}}$ Pin Output Low Voltage | V_{OL} | @ $I_{OL} = 1.0\text{mA}$ | | | 0.2 | V |
| $\overline{\text{POR}}$ Pin Internal Pull-up Resistance | R_{POR} | | 78 | 100 | 180 | $\text{k}\Omega$ |

NOTES:

- $V_{OX} = 0.98 \cdot V_{OX}(\text{NOM})$; Valid for V_{OX} greater than 1.85V.
- Parts are 100% tested at $+25^{\circ}\text{C}$. Temperature limits established by characterization and are not production tested.

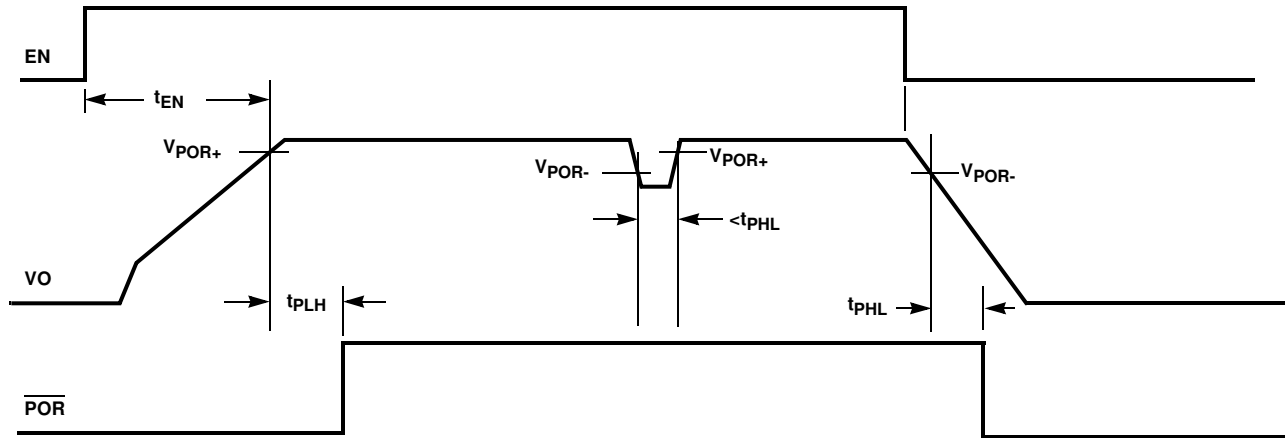

FIGURE 1. TIMING PARAMETER DEFINITION

Typical Performance Curves

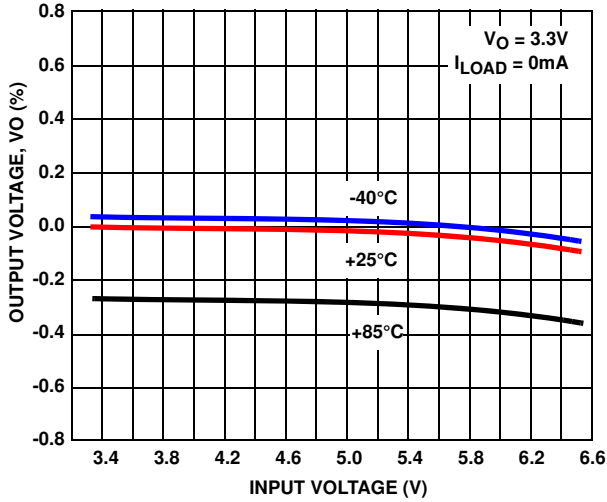

FIGURE 2. OUTPUT VOLTAGE vs INPUT VOLTAGE (3.3V OUTPUT)

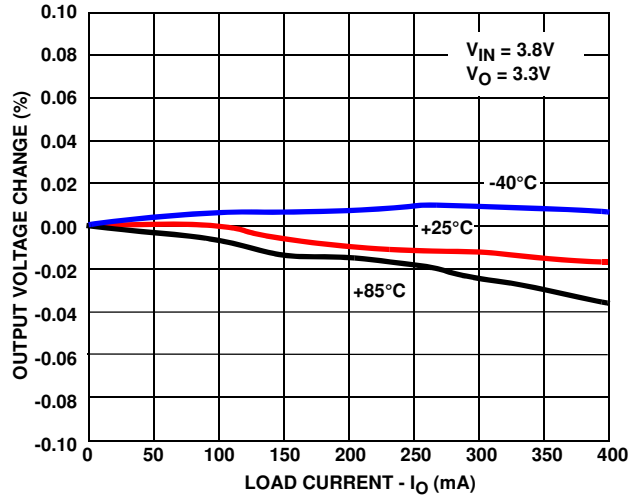

FIGURE 3. OUTPUT VOLTAGE CHANGE vs LOAD CURRENT

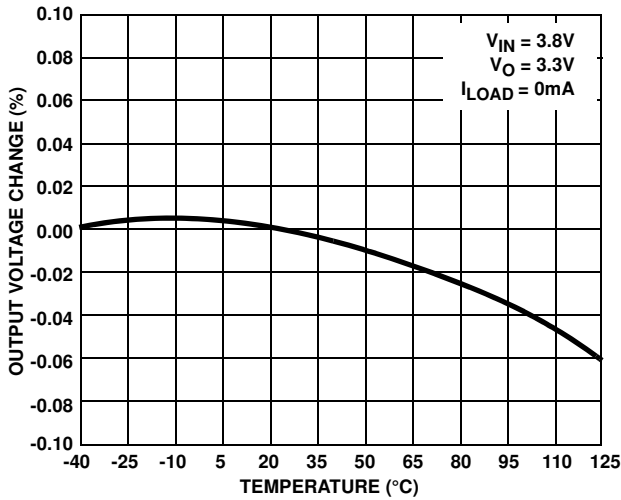

FIGURE 4. OUTPUT VOLTAGE CHANGE vs TEMPERATURE

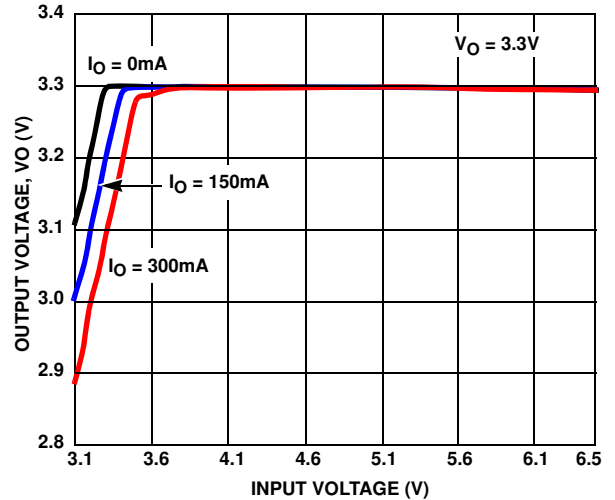

FIGURE 5. OUTPUT VOLTAGE vs INPUT VOLTAGE (3.3V OUTPUT)

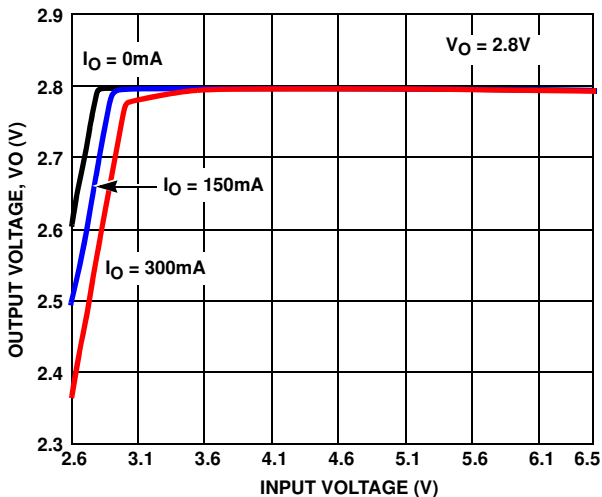

FIGURE 6. OUTPUT VOLTAGE vs INPUT VOLTAGE (2.8V OUTPUT)

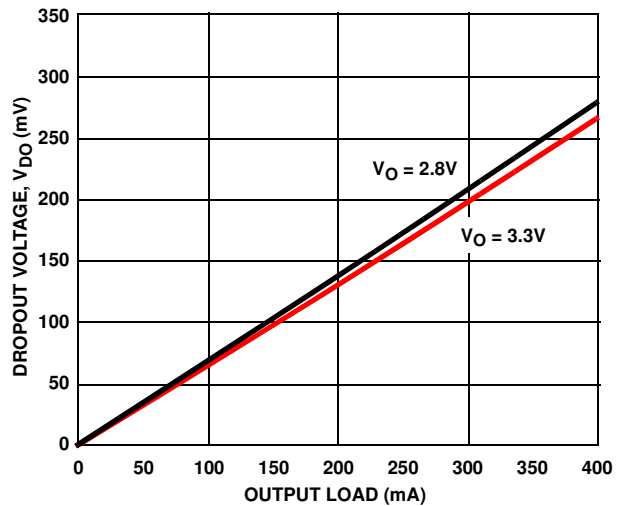

FIGURE 7. DROPOUT VOLTAGE vs LOAD CURRENT

Typical Performance Curves (Continued)

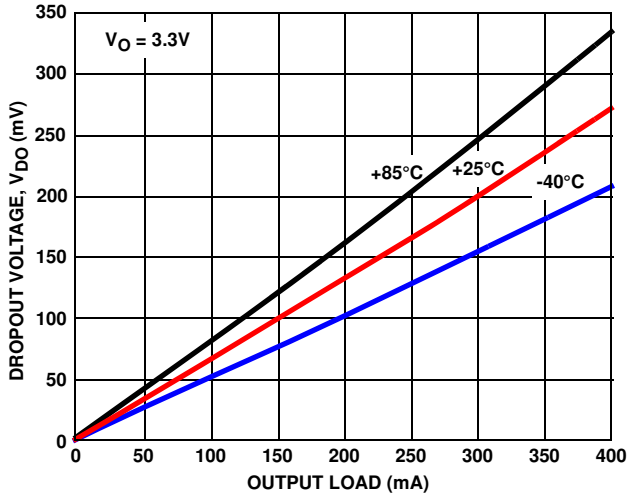

FIGURE 8. DROPOUT VOLTAGE vs LOAD CURRENT

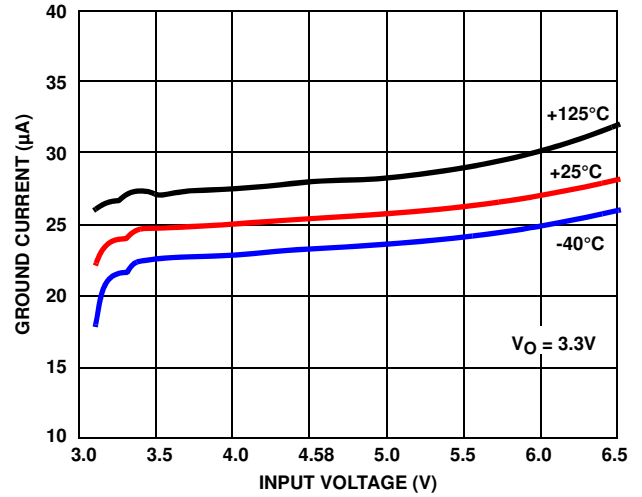

FIGURE 9. GROUND CURRENT vs INPUT VOLTAGE

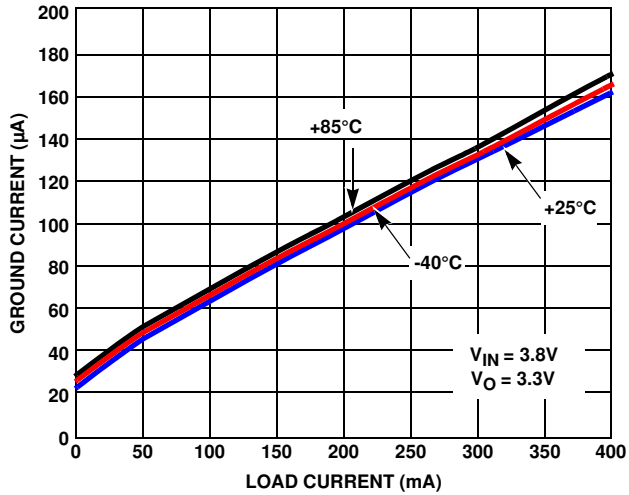

FIGURE 10. GROUND CURRENT vs LOAD

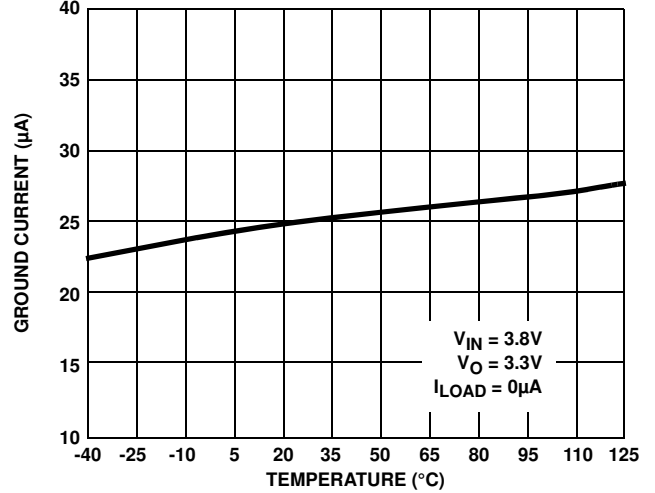

FIGURE 11. GROUND CURRENT vs TEMPERATURE

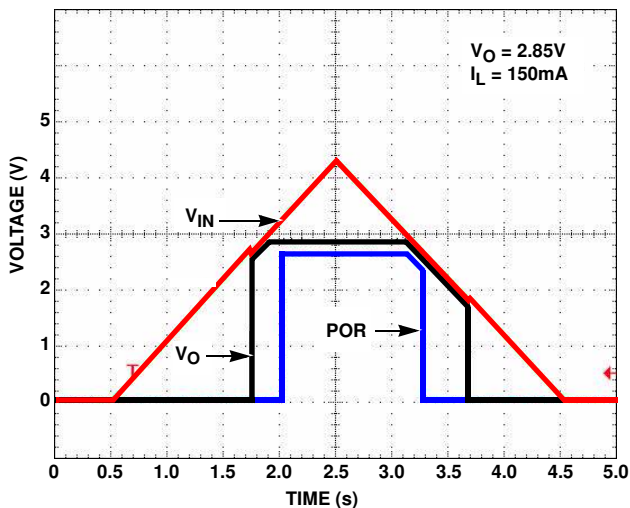

FIGURE 12. POWER-UP/POWER-DOWN

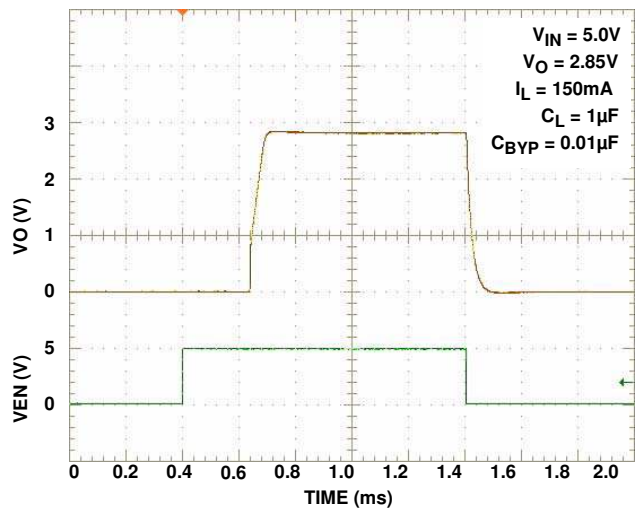

FIGURE 13. TURN-ON/TURN-OFF RESPONSE

Typical Performance Curves (Continued)

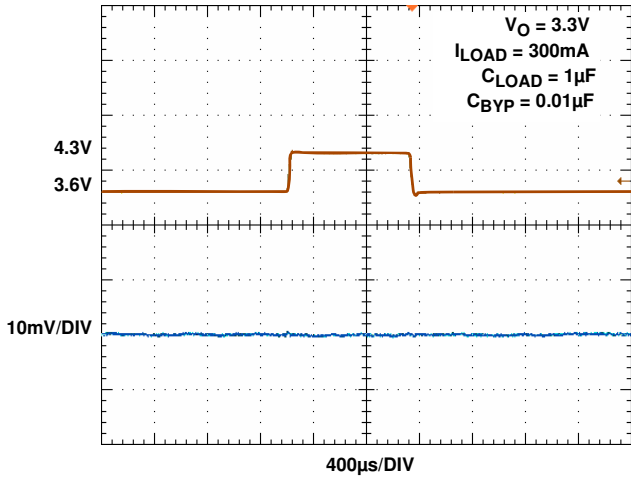

FIGURE 14. LINE TRANSIENT RESPONSE, 3.3V OUTPUT

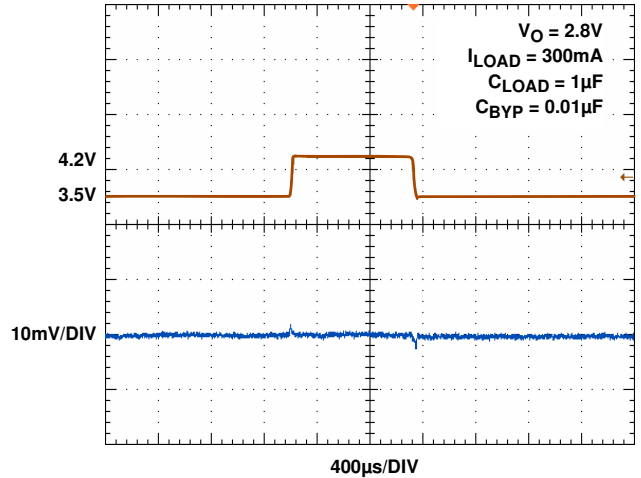

FIGURE 15. LINE TRANSIENT RESPONSE, 2.8V OUTPUT

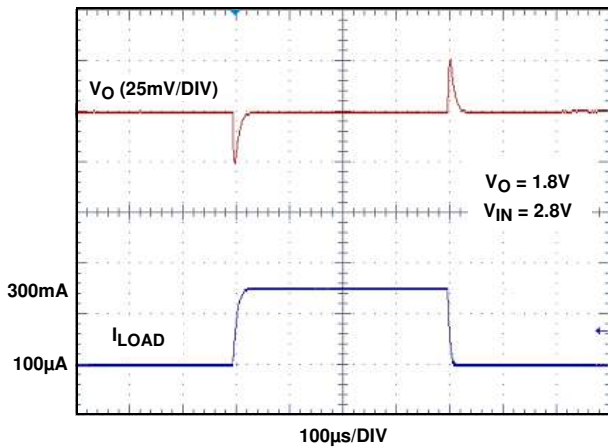

FIGURE 16. LOAD TRANSIENT RESPONSE

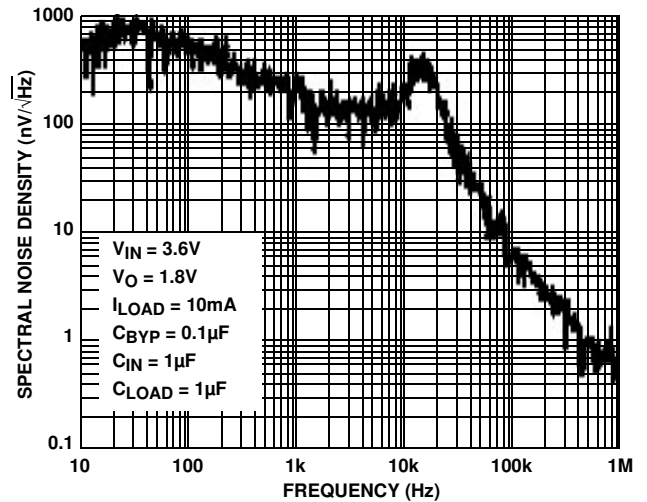

FIGURE 17. SPECTRAL NOISE DENSITY vs FREQUENCY

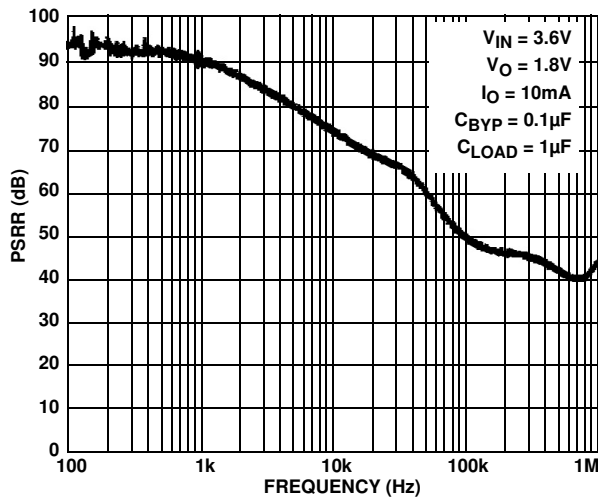
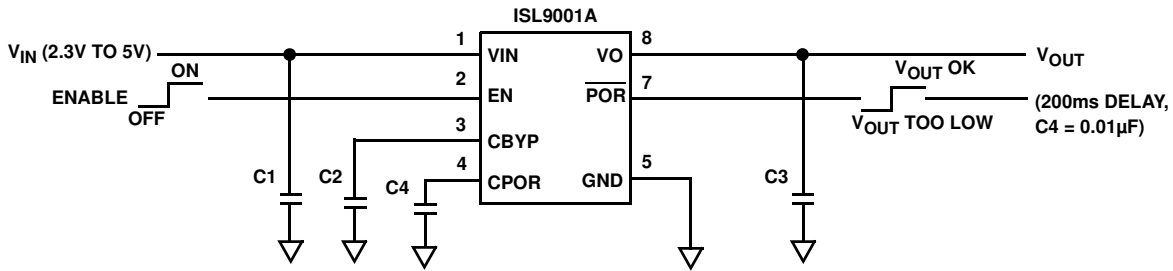

FIGURE 18. PSRR vs FREQUENCY

Pin Description

| PIN NUMBER | PIN NAME | DESCRIPTION |
|------------|-------------------------|---|
| 1 | VIN | Supply Voltage/LDO Input: Connect a 1 μ F capacitor to GND. |
| 2 | EN | LDO Enable. |
| 3 | CBYP | Reference Bypass Capacitor Pin: Optionally connect capacitor of value 0.01 μ F to 0.1 μ F between this pin and GND to achieve lowest noise and highest PSRR. |
| 4 | CPOR | POR Delay Setting Capacitor Pin: Connect a capacitor between this pin and GND to delay the $\overline{\text{POR}}$ output release after the output reaches 94% of its specified voltage level. (200ms delay per 0.01 μ F). |
| 5 | GND | GND is the connection to system ground. Connect to PCB Ground plane. |
| 6 | NC | Do not connect. |
| 7 | $\overline{\text{POR}}$ | Open-drain POR Output (active-low): Internally connected to VO through 100k Ω resistor. |
| 8 | VO | LDO Output: Connect capacitor of value 1 μ F to 10 μ F to GND (1 μ F recommended). |

Typical Application



C1, C3: 1 μ F X5R CERAMIC CAPACITOR
 C2: 0.1 μ F X7R CERAMIC CAPACITOR
 C4: 0.01 μ F X7R CERAMIC CAPACITOR

Block Diagram

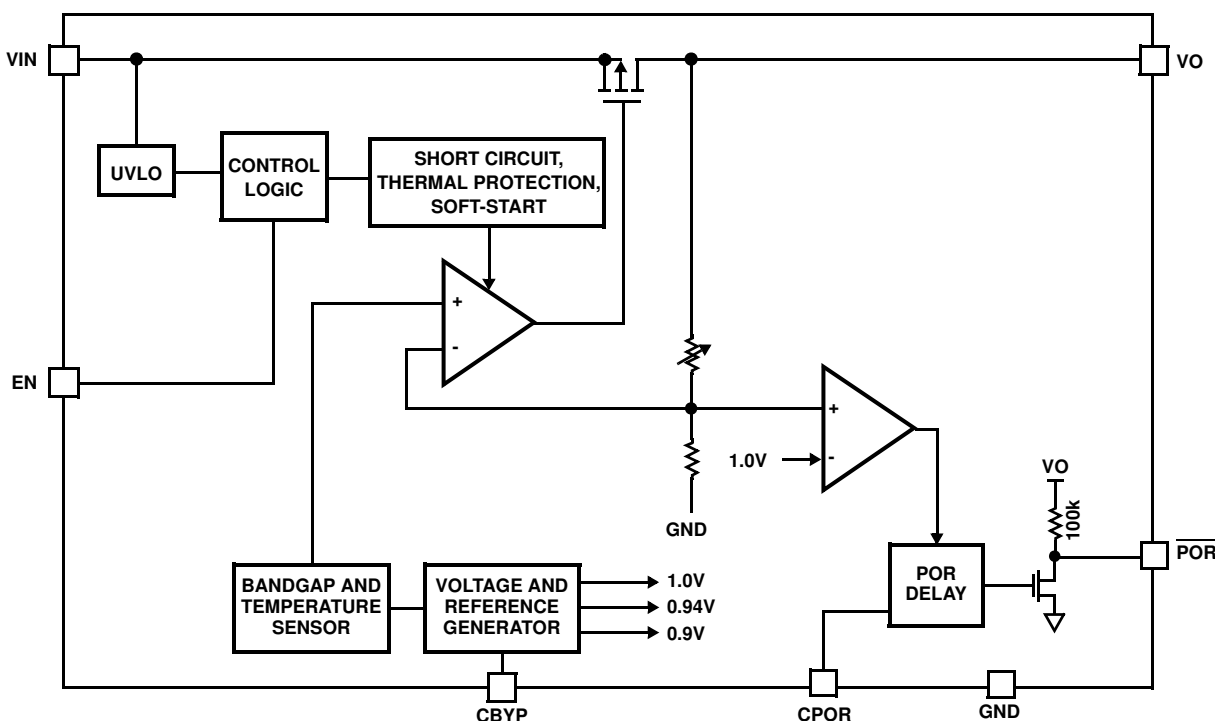

Functional Description

The ISL9001A contains all circuitry required to implement a high performance LDO. High performance is achieved through a circuit that delivers fast transient response to varying load conditions. In a quiescent condition, the ISL9001A adjusts its biasing to achieve the lowest standby current consumption.

The device also integrates current limit protection, smart thermal shutdown protection, and soft-start. Smart thermal shutdown protects the device against overheating.

Power Control

The ISL9001A has an enable pin (EN) to control power to the LDO output. When EN is low, the device is in shutdown mode. During this condition, all on-chip circuits are off, and the device draws minimum current, typically less than 0.1 μ A. When the enable pin is asserted, the device first polls the output of the UVLO detector to ensure that VIN voltage is at least about 2.1V. Once verified, the device initiates a start-up sequence. During the start-up sequence, trim settings are first read and latched. Then, sequentially, the bandgap, reference voltage and current generation circuitry power up. Once the references are stable, a fast-start circuit quickly charges the external reference bypass capacitor (connected to the CBYP pin) to the proper operating voltage. Once the bypass capacitor has been charged, the LDO powers up.

During operation, whenever the VIN voltage drops below about 1.84V, the ISL9001A immediately disables the LDO output. When VIN rises back above 2.1V, the device re-initiates its start-up sequence and LDO operation will resume automatically.

Reference Generation

The reference generation circuitry includes a trimmed bandgap, a trimmed voltage reference divider, a trimmed current reference generator, and an RC noise filter. The filter includes the external capacitor connected to the CBYP pin. A 0.01 μ F capacitor connected CBYP implements a 100Hz lowpass filter, and is recommended for most high performance applications. For the lowest noise application, a 0.1 μ F CBYP capacitor should be used. This filters the reference noise to below the 10Hz to 1kHz frequency band, which is crucial in many noise-sensitive applications.

The bandgap generates a zero temperature coefficient (TC) voltage for the reference divider. The reference divider provides the regulation reference, POR detection thresholds, and other voltage references required for current generation and over-temperature detection.

The current generator outputs references required for adaptive biasing as well as references for LDO output current limit and thermal shutdown determination.

LDO Regulation and Programmable Output Divider

The LDO Regulator is implemented with a high-gain operational amplifier driving a PMOS pass transistor. The design of the ISL9001A provides a regulator that has low quiescent current, fast transient response, and overall stability across all operating and load current conditions. LDO stability is guaranteed for a 1 μ F to 10 μ F output capacitor that has a tolerance better than 20% and ESR less than 200m Ω . The design is performance-optimized for a 1 μ F capacitor. Unless limited by the application, use of an output capacitor value above 4.7 μ F is not recommended as LDO performance improvement is minimal.

Soft-start circuitry integrated into each LDO limits the initial ramp-up rate to about 30 μ s/V to minimize current surge. The ISL9001A provides short-circuit protection by limiting the output current to about 425mA.

The LDO uses an independently trimmed 1V reference as its input. An internal resistor divider drops the LDO output voltage down to 1V. This is compared to the 1V reference for regulation. The resistor division ratio is programmed in the factory.

Power-On Reset Generation

The ISL9001A has a Power-on Reset signal generation circuit, which indicates that output power is good. The POR signal is generated as follows.

A POR comparator continuously monitors the output of the LDO. The LDO enters a power-good state when the output voltage is above 94% of the expected output voltage for a period exceeding the LDO PGOOD entry delay time (see the following). In the power-good state, the open-drain $\overline{\text{POR}}$ output is in a high-impedance state. An internal 100k Ω pull-up resistor pulls the pin up to the LDO output voltage. An external resistor can be added between the $\overline{\text{POR}}$ output and the LDO output for a faster rise time, however, the $\overline{\text{POR}}$ output should not connect through an external resistor to a supply greater than the LDO voltage.

The power-good state is exited when the LDO output falls below 90% of the expected output voltage for a period longer than the PGOOD exit delay time. While power-good is false, the ISL9001A pulls the POR pin low.

The PGOOD entry and exit delays are determined by the value of an external capacitor connected to the CPOR pin. For a 0.01 μ F capacitor, the entry and exit delays are 200ms and 25 μ s respectively. Larger or smaller capacitor values will yield proportionately longer or shorter delay times. The POR exit delay should never be allowed to be less than 10 μ s to ensure sufficient immunity against transient induced false POR triggering.

Overheat Detection

The bandgap outputs a proportional-to-temperature current that is indicative of the temperature of the silicon. This current is compared with references to determine if the device is in danger of damage due to overheating. When the die temperature reaches about +140 $^{\circ}$ C, if the LDO is sourcing more than 50mA, it shuts down until the die cools sufficiently. Once the die temperature falls back below about +110 $^{\circ}$ C, the disabled LDO is re-enabled and soft-start automatically takes place.

Dual Flat No-Lead Plastic Package (DFN)

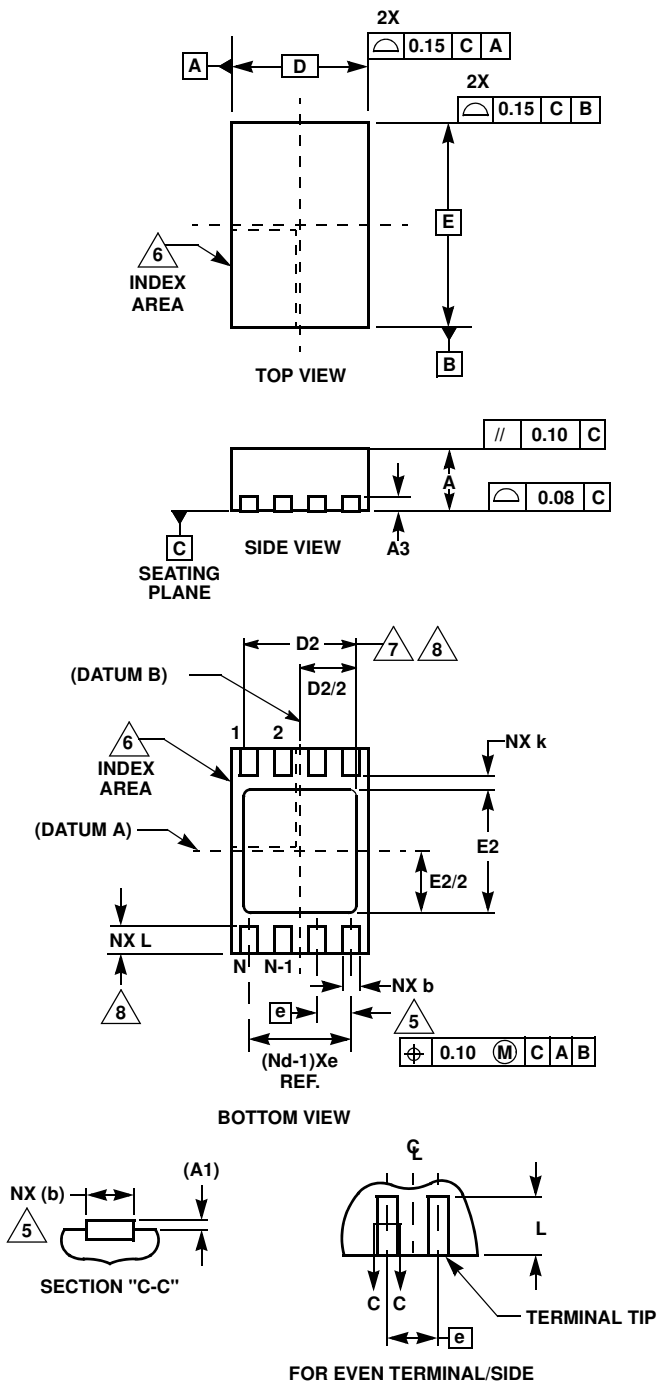

L8.2x3

8 LEAD DUAL FLAT NO-LEAD PLASTIC PACKAGE

| SYMBOL | MILLIMETERS | | | NOTES |
|--------|-------------|---------|------|-------|
| | MIN | NOMINAL | MAX | |
| A | 0.80 | 0.90 | 1.00 | - |
| A1 | - | - | 0.05 | - |
| A3 | 0.20 REF | | | - |
| b | 0.20 | 0.25 | 0.32 | 5,8 |
| D | 2.00 BSC | | | - |
| D2 | 1.50 | 1.65 | 1.75 | 7,8 |
| E | 3.00 BSC | | | - |
| E2 | 1.65 | 1.80 | 1.90 | 7,8 |
| e | 0.50 BSC | | | - |
| k | 0.20 | - | - | - |
| L | 0.30 | 0.40 | 0.50 | 8 |
| N | 8 | | | 2 |
| Nd | 4 | | | 3 |

Rev. 0 6/04

NOTES:

1. Dimensioning and tolerancing conform to ASME Y14.5-1994.
2. N is the number of terminals.
3. Nd refers to the number of terminals on D.
4. All dimensions are in millimeters. Angles are in degrees.
5. Dimension b applies to the metallized terminal and is measured between 0.25mm and 0.30mm from the terminal tip.
6. The configuration of the pin #1 identifier is optional, but must be located within the zone indicated. The pin #1 identifier may be either a mold or mark feature.
7. Dimensions D2 and E2 are for the exposed pads which provide improved electrical and thermal performance.
8. Nominal dimensions are provided to assist with PCB Land Pattern Design efforts, see Intersil Technical Brief TB389.

All Intersil U.S. products are manufactured, assembled and tested utilizing ISO9000 quality systems. Intersil Corporation's quality certifications can be viewed at www.intersil.com/design/quality

Intersil products are sold by description only. Intersil Corporation reserves the right to make changes in circuit design, software and/or specifications at any time without notice. Accordingly, the reader is cautioned to verify that data sheets are current before placing orders. Information furnished by Intersil is believed to be accurate and reliable. However, no responsibility is assumed by Intersil or its subsidiaries for its use; nor for any infringements of patents or other rights of third parties which may result from its use. No license is granted by implication or otherwise under any patent or patent rights of Intersil or its subsidiaries.

For information regarding Intersil Corporation and its products, see www.intersil.com