

## Description

The AH5773 is a high performance, single chip solution for driving single-coil brushless direct current (BLDC) fans and motors. The integrated full-bridge driver output stage uses soft switching to minimize audible switching noise and electromagnetic interference (EMI) providing a low noise solution.

To simplify circuit design and minimize external components, the device integrates a stable high sensitivity Hall-effect sensor, voltage and temperature compensated internal references, amplifiers and the output H-bridge power switches with low  $R_{DS(ON)}$ . For system flexibility, the motor speed can be controlled by changing the duty ratio of the PWM signal at the PWM pin or adjusting the supply voltage.

To help protect the motor coil, the AH5773 provides Rotor Lock Protection which shuts down the output drive if rotor lock is detected. The device automatically re-starts when the rotor lock is removed. In case of over-voltage, the device shuts down the output drive and enters standby mode to help prevent over-voltage stress on the coil. Over-temperature shutdown provides thermal protection for the device. The device enters standby mode when PWM pin is pulled low for longer than 65ms. In standby mode, AH5773 consumes less than 100 $\mu$ A.

A Tachometer output is provided by open-drain Frequency Generator (FG) Pin which allows external interface to monitor motor rotation or speed. The FG output is the magnetic change frequency.

The AH5773 is available in space saving small low profile U-DFN2020-6 and MSOP-8EP packages.

## Features

- Supports Single-Phase Full Wave BLDC Fan/Motor Drive
- Wide Operating Voltage Range: 2.4V to 18V
- Built-in High Sensitivity Hall Effect Sensor
- Built-in H-Bridge with Low  $R_{DS(ON)}$  Resistance
- PWM Input for Speed Control
- Standby Feature with  $I_{DD} < 100\mu A$
- Soft Switching for Low Noise DC Fan Motor Applications
- Rotor Lock Protection with Automatic Re-Start
- $t_{OFF}$  Clear When PWM Is Low for Greater Than 65ms
- Over Voltage Shutdown
- Thermal Protection
- Tachometer (FG) Output
- Small Low-Profile Package: U-DFN2020-6 and MSOP-8EP with Exposed Pads for Power Handling Capability
- **Totally Lead-Free & Fully RoHS Compliant (Notes 1 & 2)**
- **Halogen and Antimony Free. "Green" Device (Note 3)**

Notes: 1. No purposely added lead. Fully EU Directive 2002/95/EC (RoHS) & 2011/65/EU (RoHS 2) compliant.  
 2. See [http://www.diodes.com/quality/lead\\_free.html](http://www.diodes.com/quality/lead_free.html) for more information about Diodes Incorporated's definitions of Halogen- and Antimony-free, "Green" and Lead-free.  
 3. Halogen- and Antimony-free "Green" products are defined as those which contain <900ppm bromine, <900ppm chlorine (<1500ppm total Br + Cl) and <1000ppm antimony compounds.

## Pin Assignments

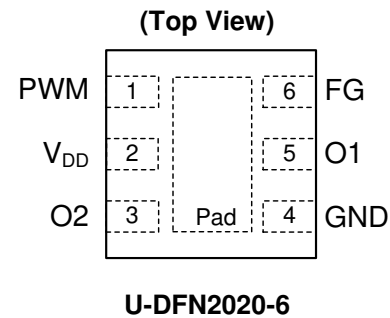
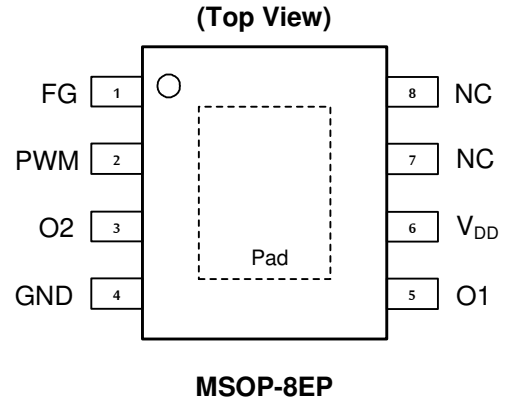

## Applications

- 5V/ 9V/ 12V/ 15V Min. BLDC Cooling Fans and Motors
- Netbook/ Notebook and Desktop BLDC Fans
- Instruments Cooling Fans
- Medium Voltage/ Low Power BLDC Motors

## Typical Applications Circuit

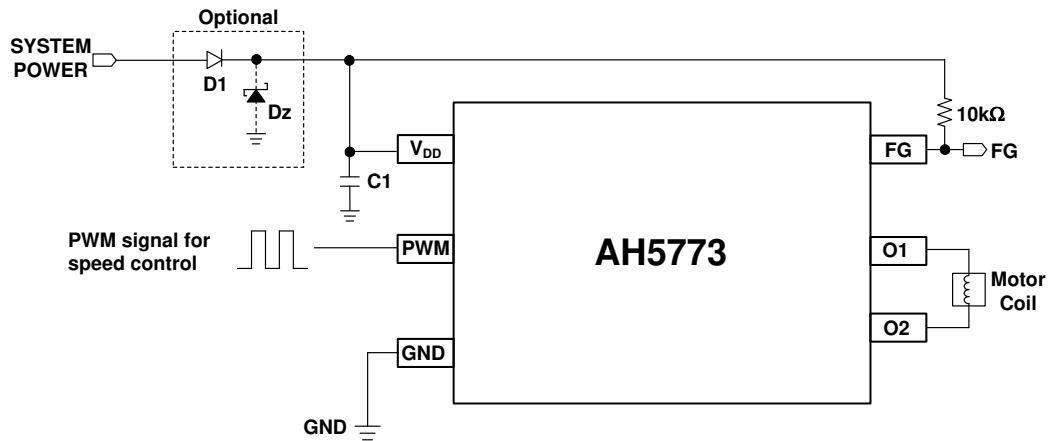

- Notes:
- C1 is for power stabilization and to strengthen the noise immunity; the recommended value is 2.2 $\mu$ F. The value of capacitor can be optimized depending on the operating mode, motor voltage and the motor current. For PWM speed control mode, with datasheet current capability, the recommended capacitor value is 2.2 $\mu$ F, for lower motor current 1 $\mu$ F and higher should be used. If PWM speed control function is not used (PWM pin tied high or not connected) the capacitor value can be reduced towards 0.1 $\mu$ F. The value of the C1 should be checked in the motor design in its operating conditions if it is reduced from the recommended value of 2.2 $\mu$ F.
  - The AH5773 has an open-drain tachometer FG output that follows the magnetic change frequency. Typically a pull-up resistor of 10k $\Omega$  is recommended from FG pin to the supply voltage.

## Pin Descriptions

### Package Type: MSOP-8EP

Pin Number	Pin Name	Description
1	FG	Frequency Generator (FG) - The FG output is the same as the magnetic change frequency
2	PWM	PWM signal input pin for speed control
3	O2	Output drive sourcing & sinking pin
4	GND	Ground pin
5	O1	Output drive sourcing & sinking pin
6	V <sub>DD</sub>	Power supply input pin
7	NC	No connection (Note 6)
8	NC	No connection (Note 6)
Pad	Pad	Exposed pad for thermal dissipation. It can be connected to GND or left open circuit.

Note: 6. NC is "No Connection" pin and is not connected internally. This pin can be left open or tied to ground.

### Package Type: U-DFN2020-6

Pin Number	Pin Name	Description
1	PWM	PWM signal input pin for speed control
2	V <sub>DD</sub>	Power supply input pin
3	O2	Output drive sourcing & sinking pin
4	GND	Ground pin
5	O1	Output drive sourcing & sinking pin
6	FG	Frequency Generator (FG) - The FG output is the same as the magnetic change frequency
Pad	Pad	Exposed pad for thermal dissipation. It can be connected to GND or left open circuit.

**Functional Block Diagram**

NEW PRODUCT

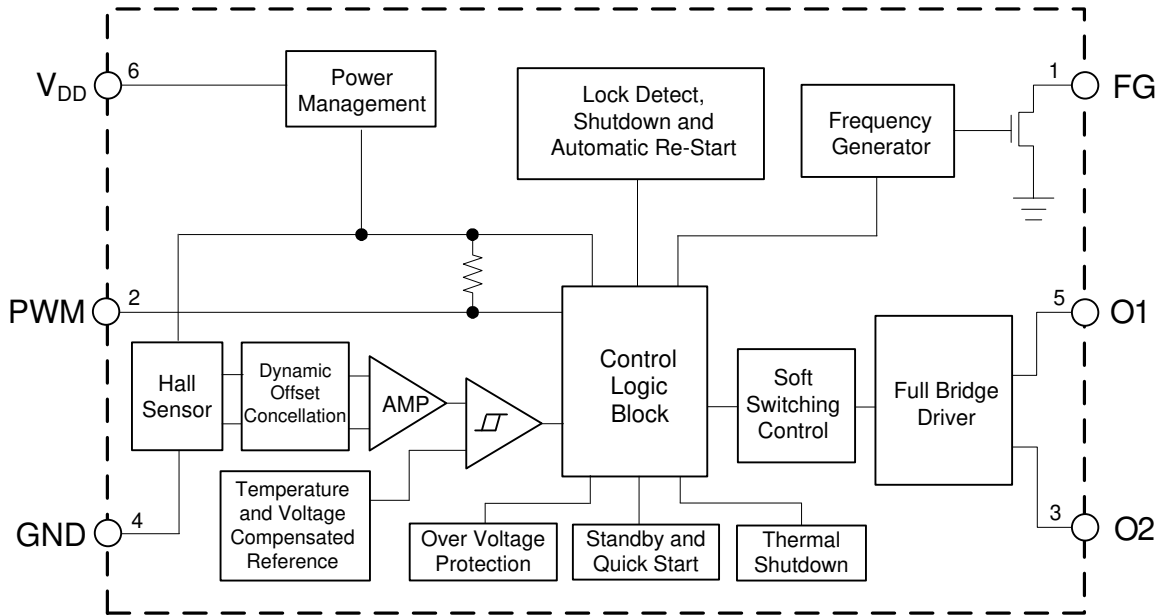

**Absolute Maximum Ratings** (Note 7) (@ $T_A = +25^\circ\text{C}$ , unless otherwise specified.)

Symbol	Characteristics	Rating	Unit	
$V_{DD\_MAX}$	Maximum Supply Voltage (Note 8)	24	V	
$V_{REVERSE}$	Reverse Supply Voltage on All Pins	-0.3	V	
$V_{PWM\_MAX}$	Maximum Voltage on Logic PWM Pin	6	V	
$I_{O(PEAK)}$	Maximum Output Current (Peak)	1,000	mA	
B	Maximum Magnetic Flux Density	Unlimited	–	
$P_D$	Power Dissipation (Note 9)	MSOP-8EP	2,180 (Note 10)	mW
		U-DFN2020-6	1,230 (Note 11)	mW
$T_{STG}$	Storage Temperature Range	-65 to +150	$^\circ\text{C}$	
$T_J$	Maximum Junction Temperature	+150	$^\circ\text{C}$	
ESD HBM	Human Body Model ESD Capability	$V_{DD}$ , O1, O2, PWM and GND pins	4	kV
		FG pin	2	kV

- Notes:
- Stresses greater than the 'Absolute Maximum Ratings' specified above may cause permanent damage to the device. These are stress ratings only; functional operation of the device at these or any other conditions exceeding those indicated in this specification is not implied. Device reliability may be affected by exposure to absolute maximum rating conditions for extended periods of time.
  - The absolute maximum  $V_{DD}$  of 24V is a transient stress rating and is not meant as a functional operating condition. It is not recommended to operate the device at the absolute maximum rated conditions for any period of time.
  - For thermal de-rating curves under different PCB size and layout conditions, see thermal performance section.
  - MSOP-8EP exposed pad soldered to minimum recommended landing pads (see Package Outline Dimension section) on 2in x 2in two-layer 2oz copper FR4 PCB (1.6mm thickness) with four thermal vias in exposed PADs to the copper flood on the bottom layer. See thermal performance section.
  - U-DFN2020-6 exposed pad soldered to minimum recommended landing pads (see Package Outline Dimension section) on 1in x 1in two-layer 2oz copper FR4 PCB (1.6mm thickness) with two thermal vias in exposed PADs to the copper flood on the bottom layer. See thermal performance section.

**Recommended Operating Conditions**

Symbol	Characteristic	Conditions	Min	Max	Unit
$V_{DD}$	Supply Voltage	Operating	2.4	18	V
$T_A$	Operating Temperature Range	Operating	-40	+105	$^\circ\text{C}$

**Electrical Characteristics** (Note 12) (@ $T_A = +25^\circ\text{C}$ ,  $V_{DD} = 12\text{V}$ , unless otherwise specified.)

Symbol	Characteristics	Conditions	Min	Typ	Max	Unit
$I_{DD}$	Supply Current	No Load, PWM switching or high	–	3.17	4.5	mA
$I_{DD\_STNDBY}$	Standby Supply Current	PWM pin = Logic Low (GND) for >65ms	–	100	–	$\mu\text{A}$
$V_{OV\_TH}$	Over Voltage Protection Threshold for Shutdown to Standby Mode	Voltage increasing	19	21	23	V
$V_{OV\_RLTH}$	Over Voltage Release Threshold	Voltage decreasing	18	20	22	V
$V_{OH}$	Output Voltage High	$V_{DD} = 12\text{V}$ , $I_{OUT} = 500\text{mA}$	$V_{DD} - 0.6$	$V_{DD} - 0.36$	–	V
		$V_{DD} = 12\text{V}$ , $I_{OUT} = 500\text{mA}$ $T_A = -40^\circ\text{C}$ to $+105^\circ\text{C}$	$V_{DD} - 0.7$	$V_{DD} - 0.36$	–	V
		$V_{DD} = 3\text{V}$ , $I_{OUT} = 300\text{mA}$	$V_{DD} - 0.32$	$V_{DD} - 0.23$	–	V
		$V_{DD} = 3\text{V}$ , $I_{OUT} = 300\text{mA}$ $T_A = -40^\circ\text{C}$ to $+105^\circ\text{C}$	$V_{DD} - 0.40$	$V_{DD} - 0.23$	–	V
$V_{OL}$	Output Voltage Low	$V_{DD} = 12\text{V}$ , $I_{OUT} = 500\text{mA}$	–	0.27	0.35	V
		$V_{DD} = 12\text{V}$ , $I_{OUT} = 500\text{mA}$ $T_A = -40^\circ\text{C}$ to $+105^\circ\text{C}$	–	0.27	0.5	V
		$V_{DD} = 3\text{V}$ , $I_{OUT} = 300\text{mA}$	–	0.18	0.24	V
		$V_{DD} = 3\text{V}$ , $I_{OUT} = 300\text{mA}$ $T_A = -40^\circ\text{C}$ to $+105^\circ\text{C}$	–	0.18	0.32	V

Note: 12. Typical data is measured at  $T_A = +25^\circ\text{C}$ ,  $V_{DD} = 12\text{V}$ . The maximum and minimum parameter values over operating temperature range are not tested in production, they are guaranteed by design, characterization and process control.

**Electrical Characteristics** (continued) (Notes 13 & 14) (@ $T_A = +25^\circ\text{C}$ ,  $V_{DD} = 12\text{V}$ , unless otherwise specified.)

Symbol	Characteristics	Conditions	Min	Typ	Max	Unit
$R_{ON\_TOTAL}$	Combined NMOS and PMOS $R_{DS(ON)}$ Including Bond Wire Resistance	$V_{DD} = 12\text{V}$ , $I_{OUT} = 500\text{mA}$	–	1.26	1.9	$\Omega$
		$V_{DD} = 12\text{V}$ , $I_{OUT} = 500\text{mA}$ $T_A = -40^\circ\text{C}$ to $+105^\circ\text{C}$	–	1.26	2.4	$\Omega$
		$V_{DD} = 3\text{V}$ , $I_{OUT} = 300\text{mA}$	–	1.37	1.87	$\Omega$
		$V_{DD} = 3\text{V}$ , $I_{OUT} = 300\text{mA}$ $T_A = -40^\circ\text{C}$ to $+105^\circ\text{C}$	–	1.37	2.4	$\Omega$
$t_{SW}$	Output Soft Switch Time	17 $\Omega$ load on out1/out2	–	200	–	$\mu\text{s}$
$t_{ON}$	On Time - Lock Detect Time	–	–	420	–	ms
$R_{DR}$	Duty Ratio - Lock Detect to Shutdown Time	$t_{OFF} / t_{ON}$	–	10	–	–
$I_{LEAK}$	FG Output Leakage Current	–	–	0.005	1	$\mu\text{A}$
$V_{FGOL}$	FG Output Voltage Low	$I_{FG} = 5\text{mA}$	–	–	0.4	V
$V_{PWMH}$	PWM Input H Level	–	2.1	–	5.5	V
$V_{PWML}$	PWM Input L Level	–	–	–	0.8	V
$I_{PWML}$	PWM Pin Current	PWM pin: $V_{PWM} = 0$	–	15	–	$\mu\text{A}$
$f_{PWM}$	PWM Input Frequency Range	–	0.05	–	50	kHz
$D_{PWM\_MIN}$	Output Duty Ratio Range	Input PWM frequency of 25kHz, no load (Note 14)	10	–	100	%
$T_{J\_SDN\_TH}$	IC Junction Temperature Thermal Shutdown Threshold	–	–	+170	–	$^\circ\text{C}$
$T_{J\_SDN\_HYST}$	IC Junction Temperature Thermal Shutdown Hysteresis	–	–	+25	–	$^\circ\text{C}$

Notes: 13. Typical data is measured at  $T_A = +25^\circ\text{C}$ ,  $V_{DD} = 12\text{V}$ . The maximum and minimum parameter values over operating temperature range are not tested in production. They are guaranteed by design, characterization and process control.  
14.  $D_{PWM\_MIN}$  is the device output PWM duty-range capability. The minimum PWM duty ratios need to start the motor turning or maintain the rotation of the motor, depending on the supply voltage to the motor and the electrical and mechanical design of the motor.

**Magnetic Characteristics** (Notes 15, 16 & 17) (@ $T_A = -40^\circ\text{C}$  to  $+105^\circ\text{C}$ ,  $V_{DD} = 2.4\text{V}$  to  $18\text{V}$ , unless otherwise specified.)

(1mT = 10 G)

Symbol	Parameter	Conditions	Min	Typ	Max	Unit
$B_{OP}$ (south pole to part marking side)	Operate Point	(Notes 15 & 17)	5	20	35	Gauss
$B_{RP}$ (north pole to part marking side)	Release Point	(Notes 15 & 17)	-35	-20	-5	
$B_{HY}$ ( $B_{OP} - B_{RP}$ )	Hysteresis	–	–	40	–	

Notes: 15. Typical data is measured at  $T_A = +25^\circ\text{C}$ ,  $V_{DD} = 12\text{V}$ . The maximum and minimum parameter values over operating temperature range are not tested in production. They are guaranteed by design, process control and characterization.  
16. Magnetic characteristics may vary with supply voltage, operating temperature and after soldering.  
17. The peak amplitude of the rotating-motor magnetic-flux density at the sensor location should be greater than +/-70G.

**Operating Characteristics**

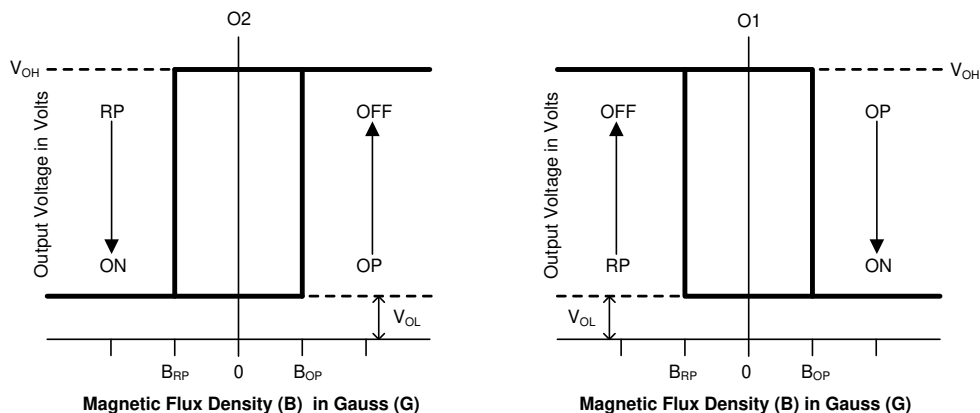

**Operating Characteristics** (continued) (Notes 18, 19, 20 & 21)

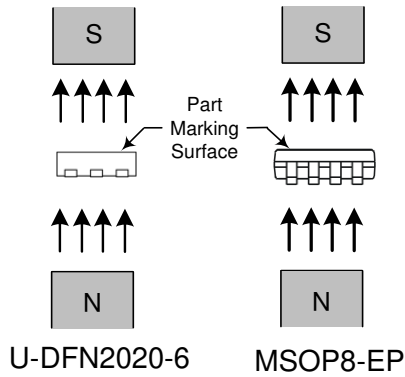

NEW PRODUCT

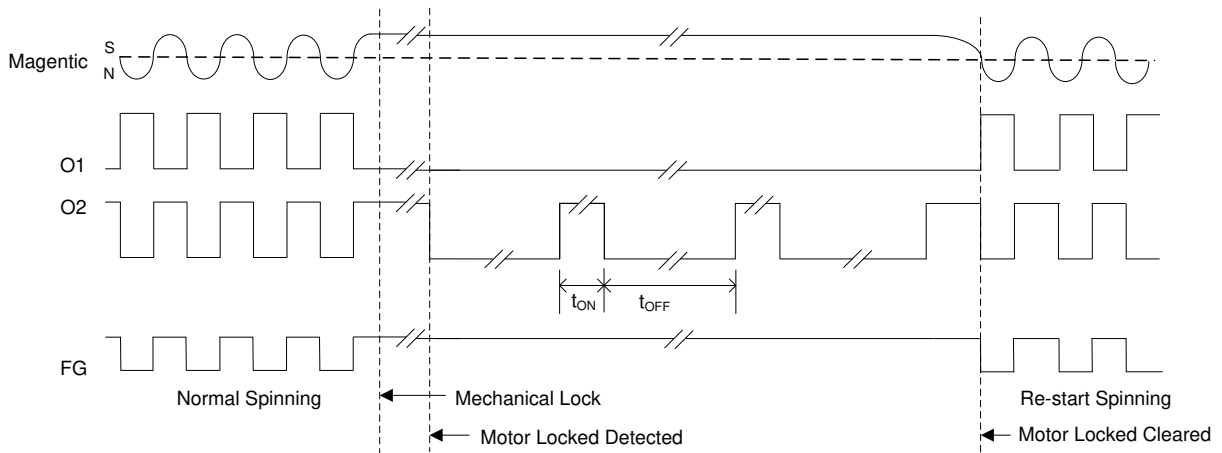

**Truth Table**

O1	O2	PWM	FG
H	L	H	L
L	H	H	H
L	L	L for >65ms	H (Note 21)

- Notes:
- 18. In "Normal Spinning", the FG changes its state at each edge of O1.
  - 19. When the motor locks with South pole at the Hall element, O2 is kept on "L" and O1 is a clock with  $t_{ON}/t_{OFF}$  ratio.  
When motor locks with North pole at the Hall element, O1 is kept on "L", O2 is a clock with  $t_{ON}/t_{OFF}$  ratio.
  - 20. When "Re-start spinning" occurs, the motor speed ramps up to the "Normal Spinning" speed from zero.  
Speed ramp-up profile depends on motor characteristics.
  - 21. In standby mode FG switch is turned off to save system power.

## Application Note

### DC Supply Voltage Speed Control

Motor speed can be controlled by varying the  $V_{DD}$  supply voltage while PWM pin is tied to  $V_{DD}$  pin.

For example, with 12V nominal motor, changing supply voltage between 12V to 2.4V, speed can be reduced from 100% to 20% typically.

### PWM Speed Control

Motor speed can also be adjusted by applying a PWM speed control signal into the PWM pin while keeping the  $V_{DD}$  pin at nominal motor voltage. The motor speed is proportional to the PWM signal duty. For example, with 12V nominal motor,  $V_{DD}$  pin is maintained at 12V typical while varying the PWM control signal duty to adjust the motor speed linearly. The figure below shows the output O1 and O2 in relation to PWM speed control signal at PWM pin.

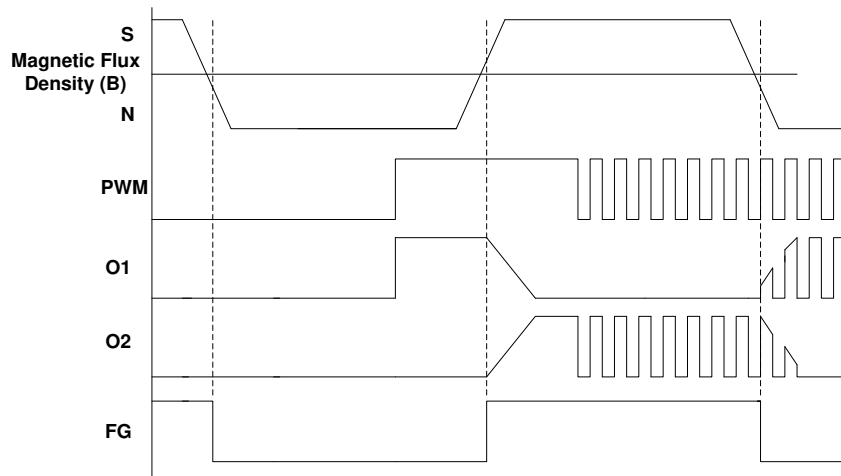

Frequency of PWM speed-control signal can be between 50Hz to 50kHz. Recommended typical PWM signal frequency is 25kHz to keep switching frequency away from audible band. AH5773 has a very good input to output PWM linearity over the operating range for no load conditions (i.e. no motor coils connected to the output). When the motor coil is connected, the non-linearity of coils and permanent magnet profile will introduce non-linearity to the motor speed against input PWM duty ratio.

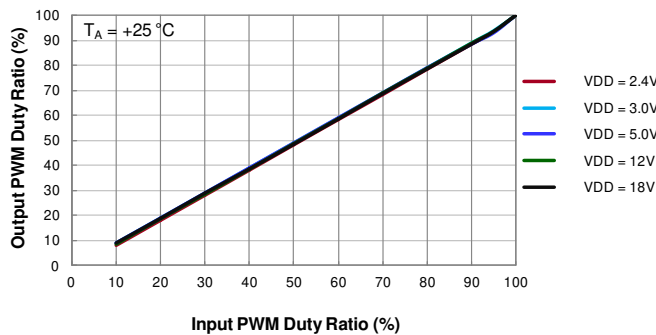

Input to Output PWM Linearity (No Load)

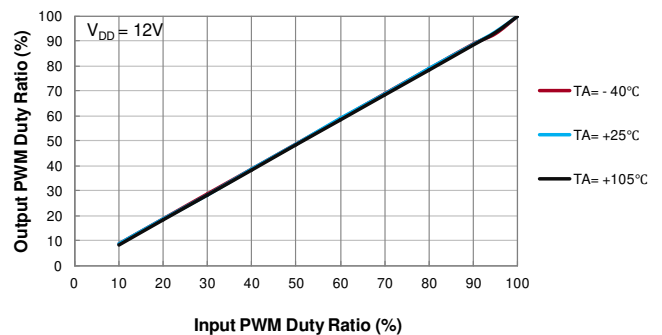

Input to Output PWM Linearity (No Load)

If PWM signal level at PWM pin stays low for longer than 65ms typical, the outputs are disabled.

Depending on the motor design and its inertia, at nominal voltage (i.e. 12V for 12V motor), minimum start-up PWM duty required can be typically between 20% - 45% while minimum running PWM duty can be down to 10% - 25% typical. If voltage at  $V_{DD}$  is lower than the nominal motor voltage, both start-up PWM duty and minimum running PWM duty required will be higher.

**Application Note** (continued)

**Standby Mode and Quick Start**

When PWM signal input at PWM pin is low for longer than 65ms, internal rotor lock protection  $t_{OFF}$  is cleared and the device enters standby mode. In standby mode typical supply current is less than  $100\mu A$ . This allows the device to enter motor start  $t_{ON}$  time on the next PWM high signal providing a quick start. When the device is enabled again, the Hall sensors take  $100\mu s$  to stabilize.

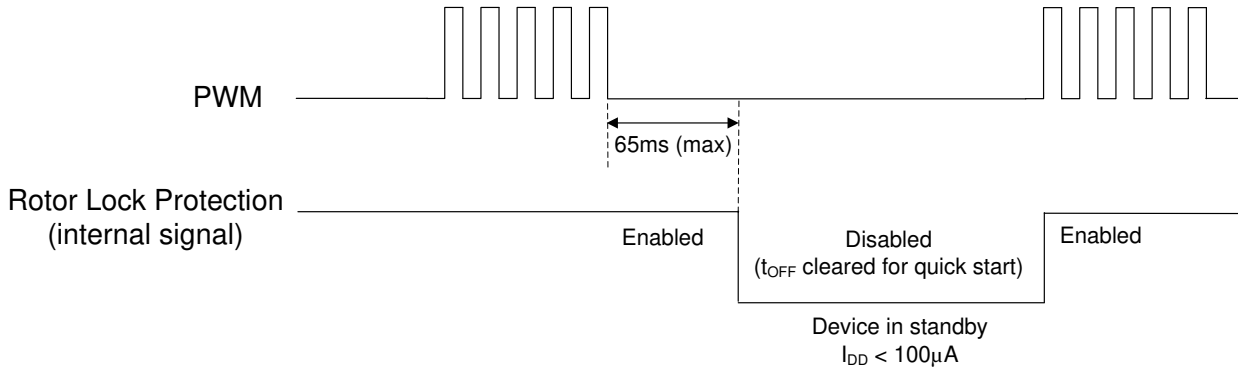

**Soft Switching**

AH5773 uses soft switching of the motor coil current during commutation to minimize audible switching noise and electromagnetic interference (EMI) to provide a low noise solution.

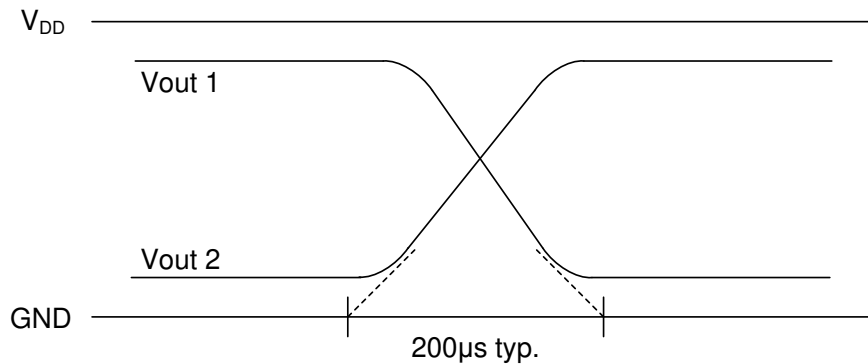

**Overvoltage Shutdown of Output Drive**

When the supply voltage reaches the over voltage shutdown threshold,  $V_{OV\_TH}$ , the AH5773 shuts down all the output drive switches and enters standby mode to help prevent over-voltage stress on the coil.

NEW PRODUCT



**Typical Operating Characteristics**

**Typical Magnetic Operating Switch Points**

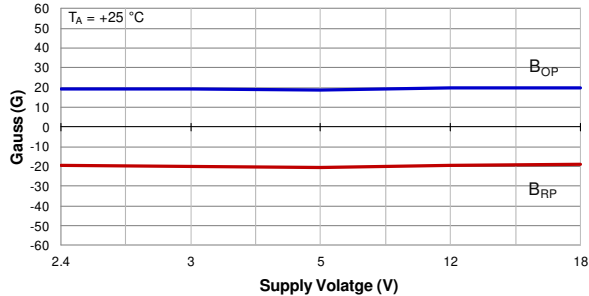

Magnetic Switch Points Bop & Brp vs. Supply Voltage

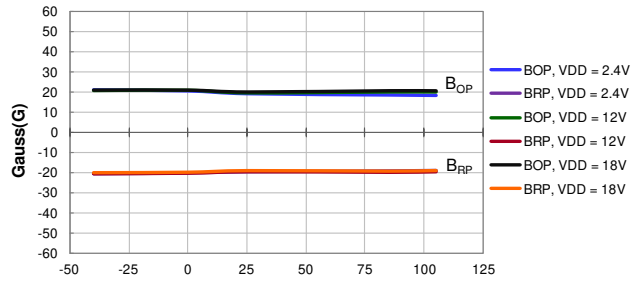

Magnetic Switch Points Bop & Brp vs. Temperature

**Average Supply Current**

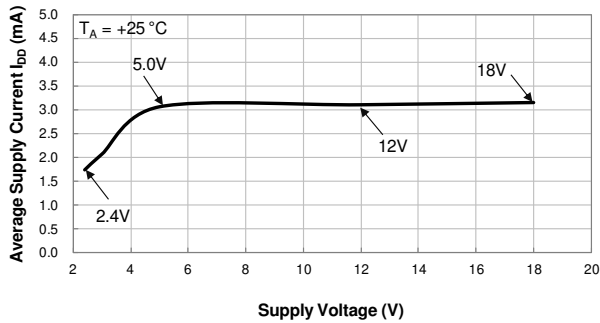

Average Supply Current vs. Supply Voltage

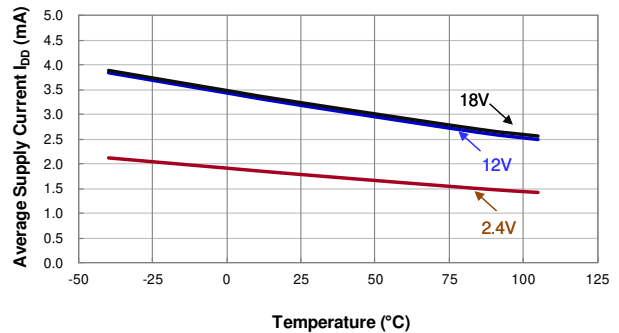

Average Supply Current vs. Temperature

**Lock Detect tON and Shutdown tOFF Periods**

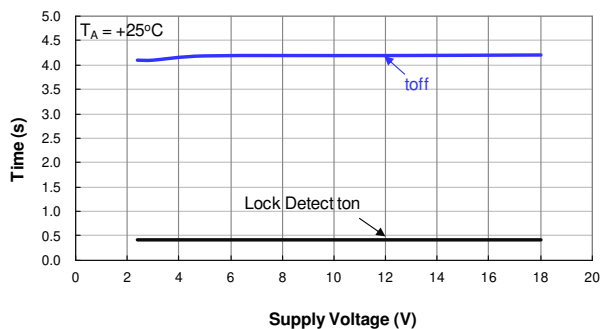

Lock Detect Ton and Toff vs. Supply Voltage

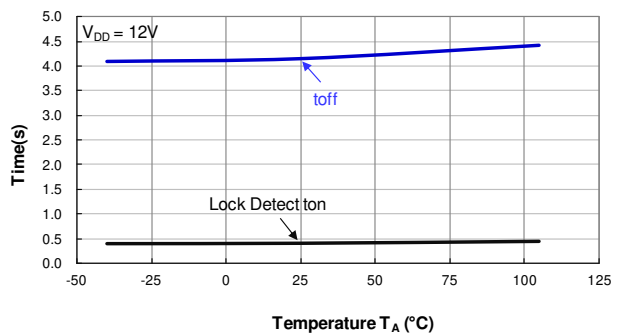

Lock Detect Ton and Toff vs. Temperature

NEW PRODUCT

**Typical Operating Characteristics** (continued)

**Total H-Bridge Path Resistance – Total  $R_{DS(ON)}$  of High Side and Low Side Switches**

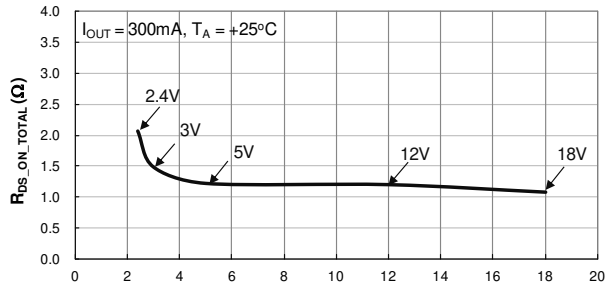

Supply Voltage (V)  
High+Low Side Resistance  $R_{DS(ON\_TOTAL)}$  vs. Supply Voltage

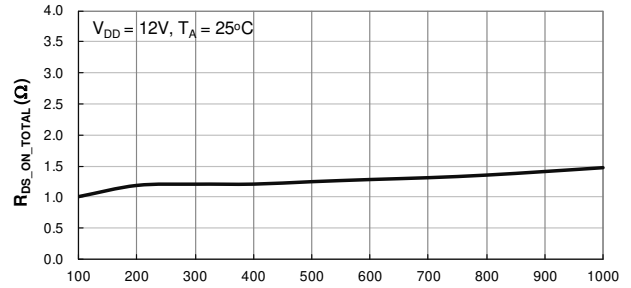

Output Current (mA)  
High+Low Side Resistance  $R_{DS(ON\_TOTAL)}$  vs. Current

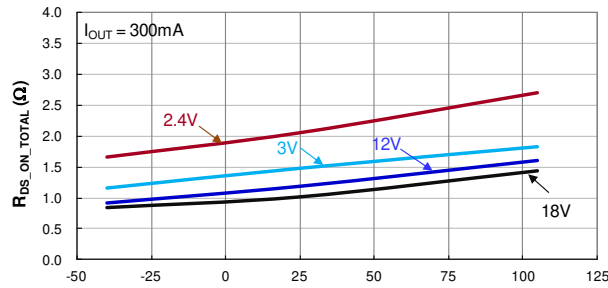

Temperature  $T_A$  (°C)  
High+Low Side Resistance  $R_{DS(ON\_TOTAL)}$  vs. Temperature

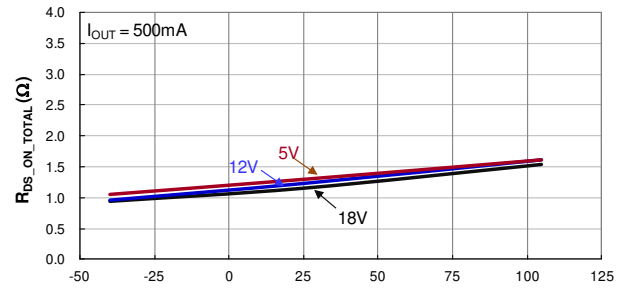

Temperature  $T_A$  (°C)  
High+Low Side Resistance  $R_{DS(ON\_TOTAL)}$  vs. Temperature

NEW PRODUCT

## Thermal Performance

### MSOP-8EP Power Dissipation De-rating Curve 1 (Note 22)

T <sub>A</sub> (°C)	-40	0	25	50	60	70	80	85	90	95	100	105	110	120	125	130	140	150
P <sub>D</sub> (mW)	2,180	2,180	2,180	1,744	1,570	1,395	1,221	1,134	1,046	959	872	785	698	523	436	349	174	0

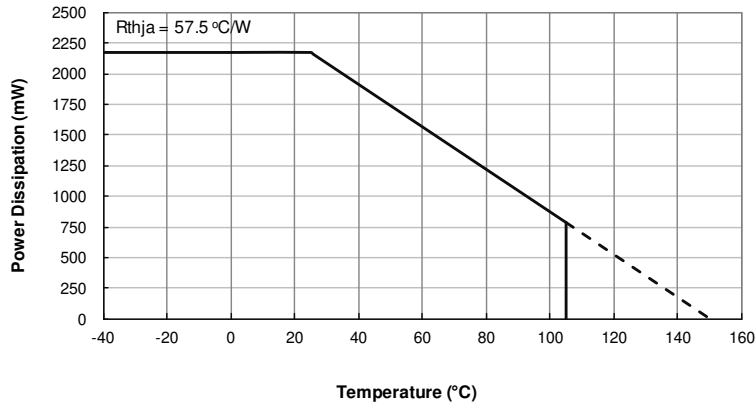

MSOP-8EP Thermal Derating Curve

Note 22: MSOP-8EP exposed pad soldered to minimum recommended landing pads (see Package Outline Dimension section) on a 2in x 2in two-layer 2oz copper FR4 PCB (1.6mm thickness) with four thermal vias in the exposed PAD to the copper flood on the bottom layer.

### MSOP-8EP Power Dissipation De-rating Curve 2 (Note 23)

T <sub>A</sub> (°C)	-40	0	25	50	60	70	80	85	90	95	100	105	110	120	125	130	140	150
P <sub>D</sub> (mW)	710	710	710	568	511	454	398	369	341	312	284	256	227	170	142	114	57	0

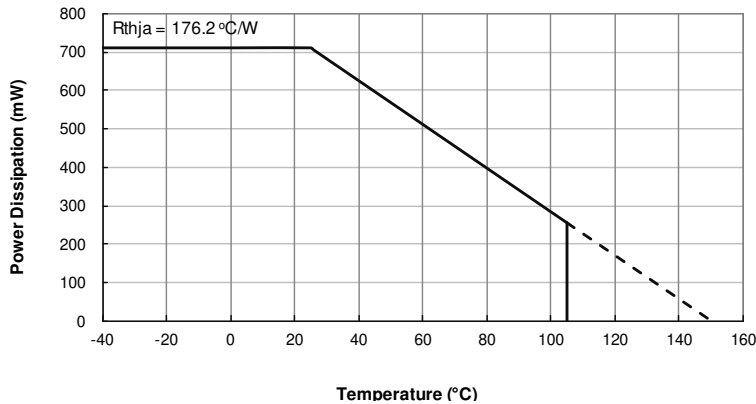

MSOP-8EP Thermal Derating Curve

Note 23: MSOP-8EP exposed pad soldered to minimum recommended landing pads (see Package Outline Dimension section) on a 1in x 1in 2oz copper FR4 PCB (1.6mm thickness) with no thermal vias in the exposed PAD or any copper flood connecting to the landing pattern or on the bottom layer.

**Thermal Performance** (continued)

(1) Package Type: U-DFN2020-6

**U-DFN2020-6 Power Dissipation De-rating Curve 1** (Note 24)

T <sub>A</sub> (°C)	-40	0	25	50	60	70	80	85	90	95	100	105	110	120	125	130	140	150
P <sub>D</sub> (mW)	1230	1230	1230	984	886	787	689	640	590	541	492	443	394	295	246	197	98	0

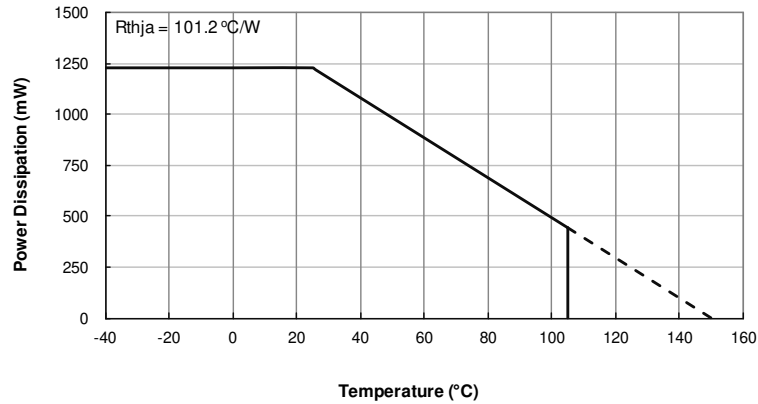

**U-DFN2020-6 Thermal Derating Curve**

Note 24: U-DFN2020-6 exposed pad soldered to minimum recommended landing pads (see Package Outline Dimension section) on a 1in x1in two-layer 2oz copper FR4 PCB (1.6mm thickness) with two thermal vias in the exposed PAD to the copper flood on the bottom layer.

**U-DFN2020-6 Power Dissipation De-rating Curve 2** (Note 25)

T <sub>A</sub> (°C)	-40	0	25	50	60	70	80	85	90	95	100	105	110	120	125	130	140	150
P <sub>D</sub> (mW)	670	670	670	536	482	429	375	348	322	295	268	241	214	161	134	107	54	0

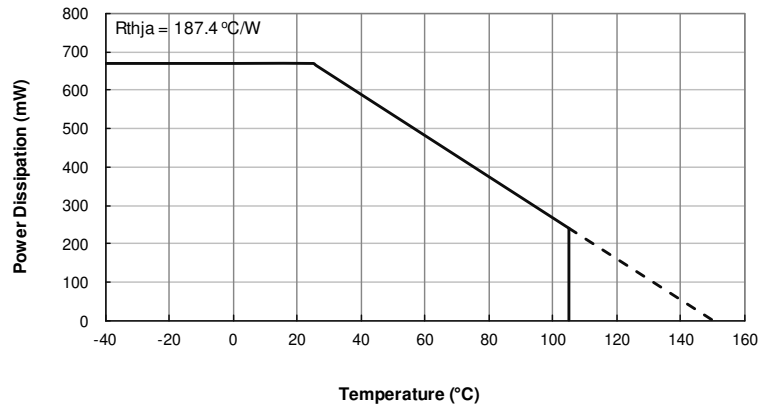

**U-DFN2020-6 Thermal Derating Curve**

Note 25: U-DFN2020-6 exposed pad soldered to minimum recommended landing pads (see Package Outline Dimension section) on a 1in x1in two-layer 2oz copper FR4 PCB (1.6mm thickness) with no thermal vias or any copper flood connecting to the landing pattern or the bottom layer.

**Ordering Information**

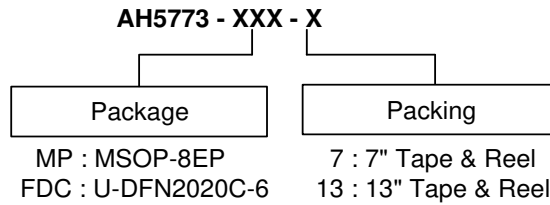

Part Number	Package Code	Packaging	13" Tape and Reel	
			Quantity	Part Number Suffix
AH5773-MP-13	MP	MSOP-8EP	2,500/Tape & Reel	-13
AH5773-FDC-7	FDC	U-DFN2020-6	3,000/Tape & Reel	-7

**Marking Information**

(1) Package Type: MSOP-8EP

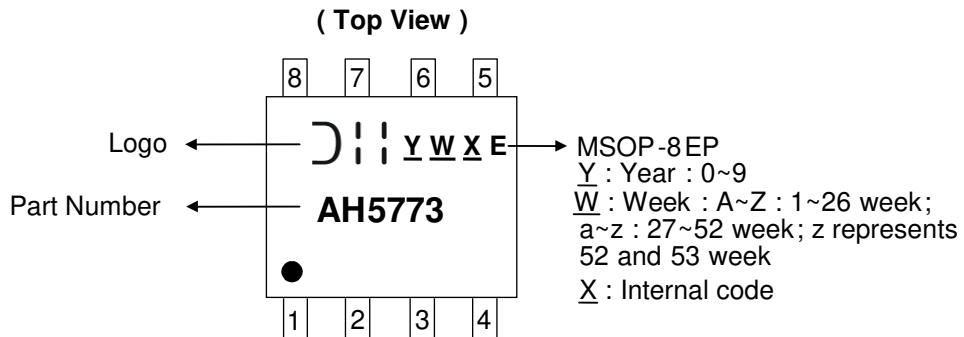

(2) Package Type: U-DFN2020-6

( Top View )

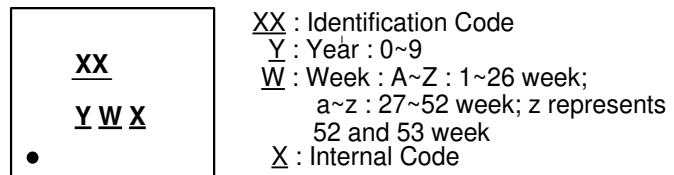

Part Number	Package	Identification Code
AH5773-FDC-7	U-DFN2020-6	KH

**Package Outline Dimensions** (All dimensions in mm.)

Please see AP02002 at <http://www.diodes.com/datasheets/ap02002.pdf> for the latest version.

(1) Package Type: MSOP-8EP

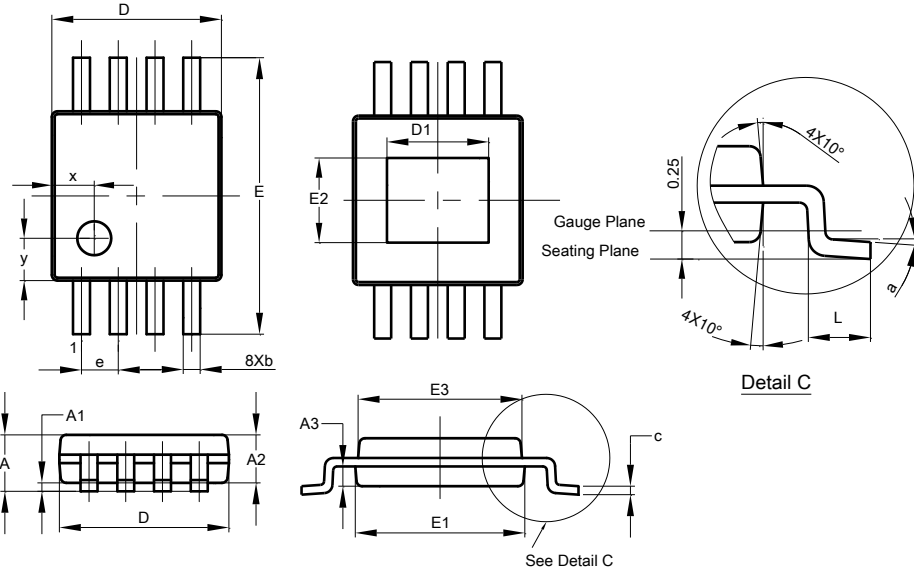

MSOP-8EP			
Dim	Min	Max	Typ
A	-	1.10	-
A1	0.05	0.15	0.10
A2	0.75	0.95	0.86
A3	0.29	0.49	0.39
b	0.22	0.38	0.30
c	0.08	0.23	0.15
D	2.90	3.10	3.00
D1	1.60	2.00	1.80
E	4.70	5.10	4.90
E1	2.90	3.10	3.00
E2	1.30	1.70	1.50
E3	2.85	3.05	2.95
e	-	-	0.65
L	0.40	0.80	0.60
a	0°	8°	4°
x	-	-	0.750
y	-	-	0.750

**All Dimensions in mm**

NEW PRODUCT

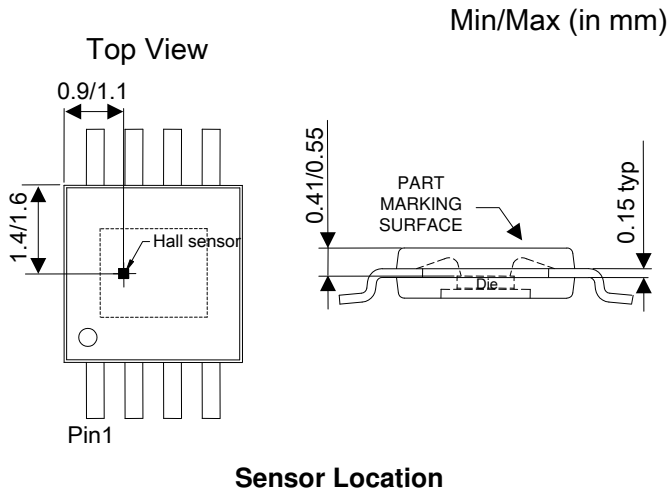

**Package Outline Dimensions** (All dimensions in mm.)

Please see AP02002 at <http://www.diodes.com/datasheets/ap02002.pdf> for the latest version.

(2) Package Type: U-DFN2020-6 (Type C)

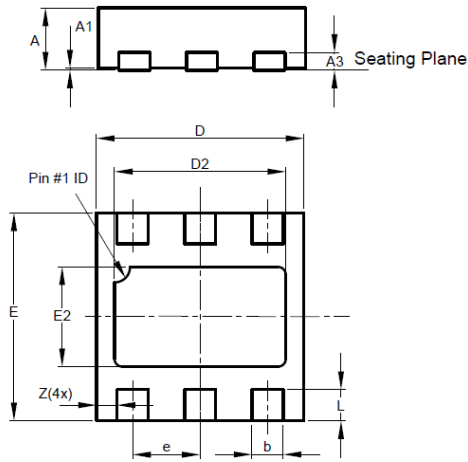

U-DFN2020-6 (Type C)			
Dim	Min	Max	Typ
A	0.57	0.63	0.60
A1	0.00	0.05	0.02
A3	-	-	0.15
b	0.25	0.35	0.30
D	1.95	2.075	2.00
D2	1.55	1.75	1.65
E	1.95	2.075	2.00
E2	0.86	1.06	0.96
e	-	-	0.65
L	0.25	0.35	0.30
Z	-	-	0.20
All Dimensions in mm			

[KST2]

**Bottom View**

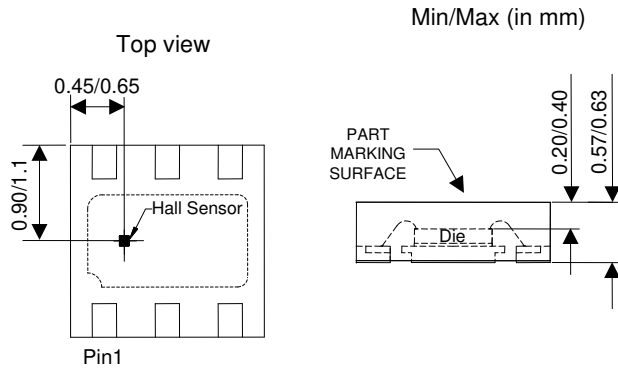

**Sensor Location**

NEW PRODUCT

## Suggested Pad Layout

Please see AP02001 at <http://www.diodes.com/datasheets/ap02001.pdf> for the latest version.

### (1) Package Type: MSOP-8EP

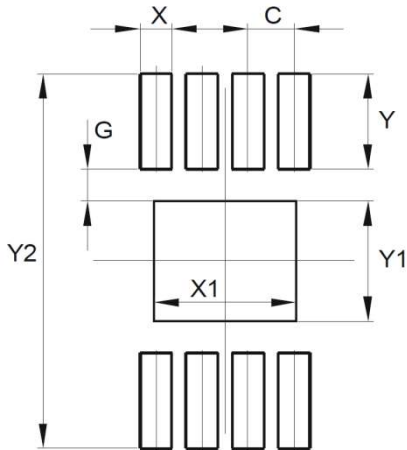

Dimensions	Value (in mm)
C	0.650
G	0.450
X	0.450
X1	2.000
Y	1.350
Y1	1.700
Y2	5.300

### (2) Package Type: U-DFN2020-6

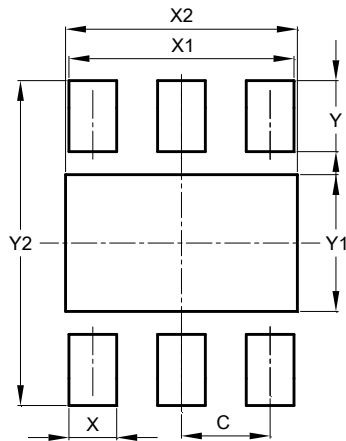

Dimensions	Value (in mm)
C	0.650
X	0.350
X1	1.650
X2	1.700
Y	0.525
Y1	1.010
Y2	2.400



**IMPORTANT NOTICE**

DIODES INCORPORATED MAKES NO WARRANTY OF ANY KIND, EXPRESS OR IMPLIED, WITH REGARDS TO THIS DOCUMENT, INCLUDING, BUT NOT LIMITED TO, THE IMPLIED WARRANTIES OF MERCHANTABILITY AND FITNESS FOR A PARTICULAR PURPOSE (AND THEIR EQUIVALENTS UNDER THE LAWS OF ANY JURISDICTION).

Diodes Incorporated and its subsidiaries reserve the right to make modifications, enhancements, improvements, corrections or other changes without further notice to this document and any product described herein. Diodes Incorporated does not assume any liability arising out of the application or use of this document or any product described herein; neither does Diodes Incorporated convey any license under its patent or trademark rights, nor the rights of others. Any Customer or user of this document or products described herein in such applications shall assume all risks of such use and will agree to hold Diodes Incorporated and all the companies whose products are represented on Diodes Incorporated website, harmless against all damages.

Diodes Incorporated does not warrant or accept any liability whatsoever in respect of any products purchased through unauthorized sales channel. Should Customers purchase or use Diodes Incorporated products for any unintended or unauthorized application, Customers shall indemnify and hold Diodes Incorporated and its representatives harmless against all claims, damages, expenses, and attorney fees arising out of, directly or indirectly, any claim of personal injury or death associated with such unintended or unauthorized application.

Products described herein may be covered by one or more United States, international or foreign patents pending. Product names and markings noted herein may also be covered by one or more United States, international or foreign trademarks.

This document is written in English but may be translated into multiple languages for reference. Only the English version of this document is the final and determinative format released by Diodes Incorporated.

**LIFE SUPPORT**

Diodes Incorporated products are specifically not authorized for use as critical components in life support devices or systems without the express written approval of the Chief Executive Officer of Diodes Incorporated. As used herein:

A. Life support devices or systems are devices or systems which:

1. are intended to implant into the body, or
2. support or sustain life and whose failure to perform when properly used in accordance with instructions for use provided in the labeling can be reasonably expected to result in significant injury to the user.

B. A critical component is any component in a life support device or system whose failure to perform can be reasonably expected to cause the failure of the life support device or to affect its safety or effectiveness.

Customers represent that they have all necessary expertise in the safety and regulatory ramifications of their life support devices or systems, and acknowledge and agree that they are solely responsible for all legal, regulatory and safety-related requirements concerning their products and any use of Diodes Incorporated products in such safety-critical, life support devices or systems, notwithstanding any devices- or systems-related information or support that may be provided by Diodes Incorporated. Further, Customers must fully indemnify Diodes Incorporated and its representatives against any damages arising out of the use of Diodes Incorporated products in such safety-critical, life support devices or systems.

Copyright © 2015, Diodes Incorporated

[www.diodes.com](http://www.diodes.com)