

2SC6023 — NPN Epitaxial Planar Silicon Transistor

UHF to C Band Low-Noise Amplifier and OSC Applications

Features

- Low-noise use : NF=1.2dB typ (f=2GHz).
- High cut-off frequency : $f_T=14.5\text{GHz}$ typ ($V_{CE}=1\text{V}$).
- High cut-off frequency : $f_T=22\text{GHz}$ typ ($V_{CE}=3\text{V}$).
- Low operating voltage.
- High gain : $|S_{21e}|^2=14\text{dB}$ typ (f=2GHz).

Specifications

Absolute Maximum Ratings at $T_a=25^\circ\text{C}$

Parameter	Symbol	Conditions	Ratings	Unit
Collector-to-Base Voltage	V_{CB0}		9	V
Collector-to-Emitter Voltage	V_{CEO}		3.5	V
Emitter-to-Base Voltage	V_{EBO}		2	V
Collector Current	I_C		35	mA
Collector Dissipation	P_C		120	mW
Junction Temperature	T_J		150	$^\circ\text{C}$
Storage Temperature	T_{stg}		-55 to +150	$^\circ\text{C}$

Electrical Characteristics at $T_a=25^\circ\text{C}$

Parameter	Symbol	Conditions	Ratings			Unit
			min	typ	max	
Collector Cutoff Current	I_{CB0}	$V_{CB}=5\text{V}, I_E=0$			1.0	μA
Emitter Cutoff Current	I_{EBO}	$V_{EB}=1\text{V}, I_C=0$			1	μA
DC Current Gain	h_{FE}	$V_{CE}=3\text{V}, I_C=15\text{mA}$	80		160	
Gain-Bandwidth Product	f_T1	$V_{CE}=1\text{V}, I_C=5\text{mA}$		14.5		GHz
	f_T2	$V_{CE}=3\text{V}, I_C=15\text{mA}$	18	22		GHz
Reverse Transfer Capacitance	C_{re}	$V_{CB}=1\text{V}, f=1\text{MHz}$		0.18		pF
Forward Transfer Gain	$ S_{21e} ^2_1$	$V_{CE}=1\text{V}, I_C=5\text{mA}, f=2\text{GHz}$	9.5	11		dB
	$ S_{21e} ^2_2$	$V_{CE}=3\text{V}, I_C=15\text{mA}, f=2\text{GHz}$		14		dB
Noise Figure	NF	$V_{CE}=1\text{V}, I_C=5\text{mA}, f=2\text{GHz}$		1.2		dB

Marking : NF

- Any and all SANYO products described or contained herein do not have specifications that can handle applications that require extremely high levels of reliability, such as life-support systems, aircraft's control systems, or other applications whose failure can be reasonably expected to result in serious physical and/or material damage. Consult with your SANYO representative nearest you before using any SANYO products described or contained herein in such applications.
- SANYO assumes no responsibility for equipment failures that result from using products at values that exceed, even momentarily, rated values (such as maximum ratings, operating condition ranges, or other parameters) listed in products specifications of any and all SANYO products described or contained herein.

Package Dimensions

unit : mm
2161A

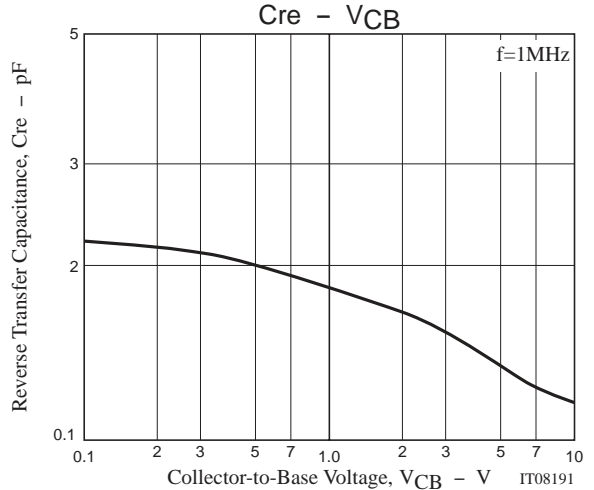
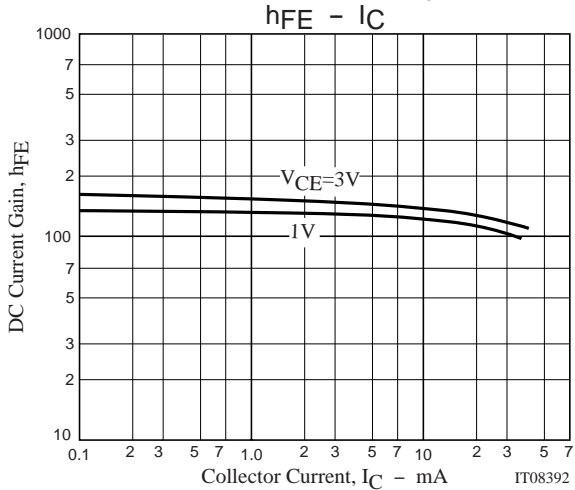
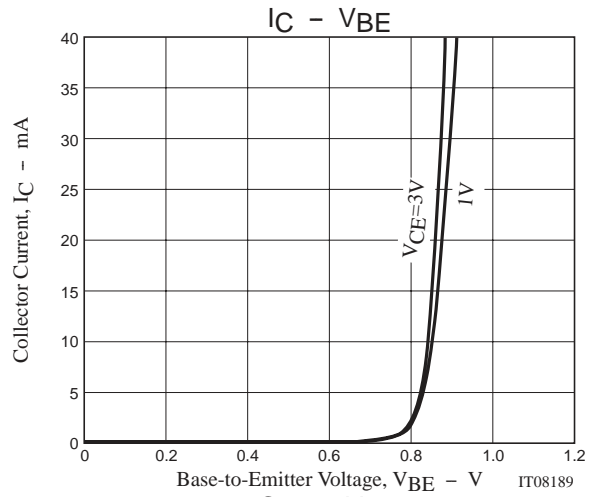
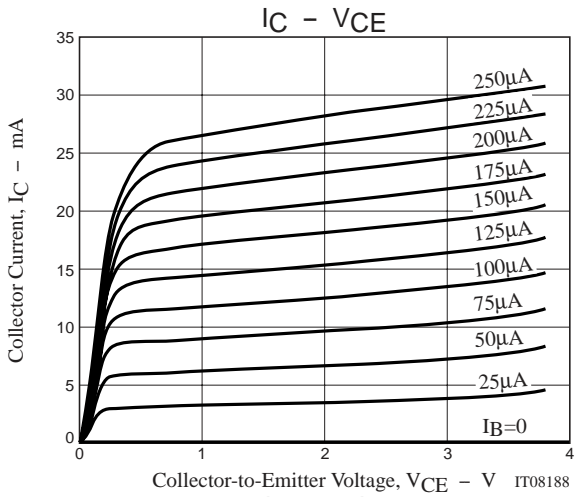
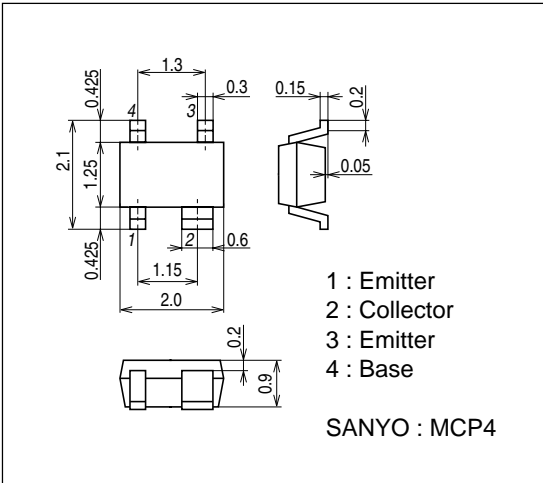

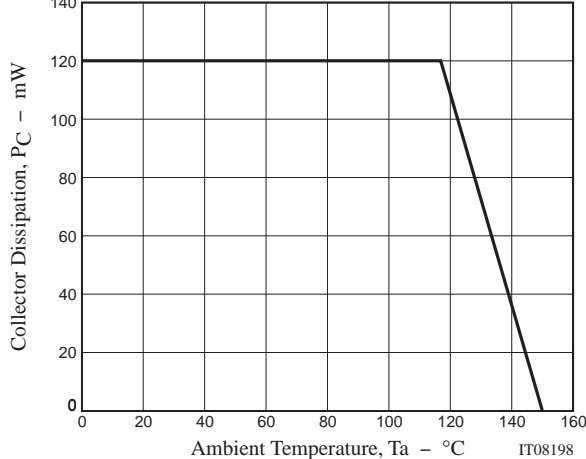
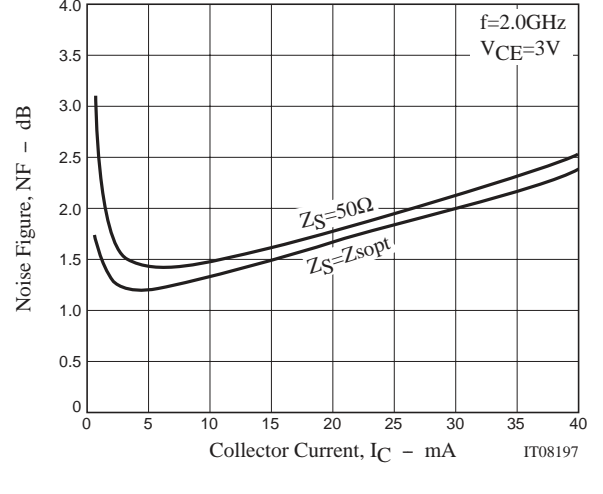
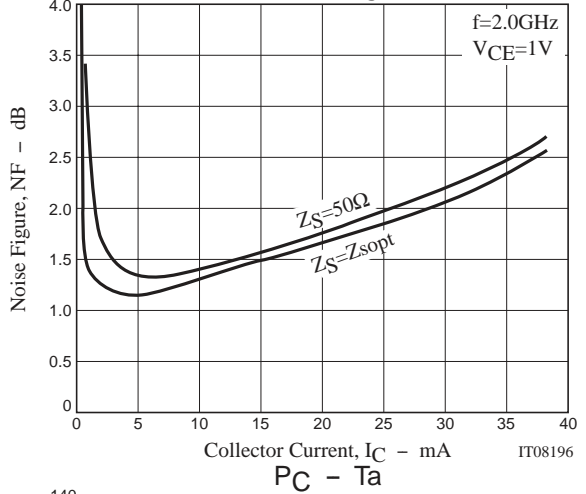
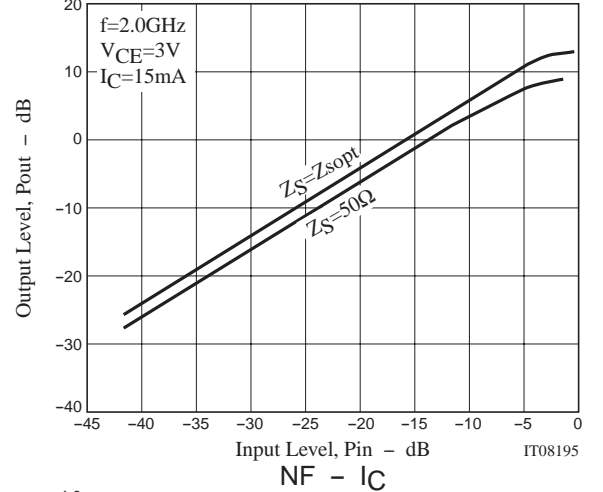
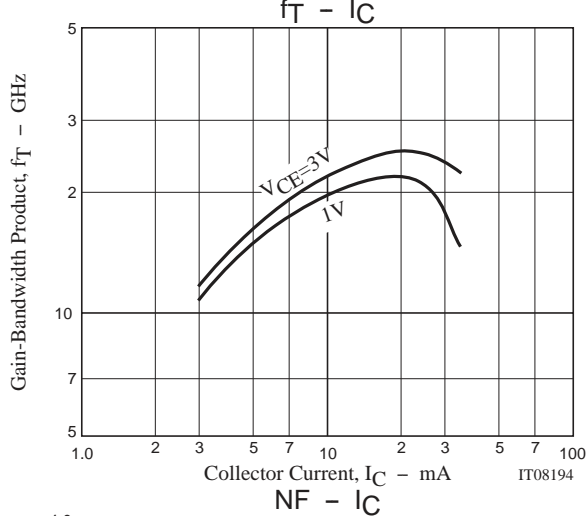
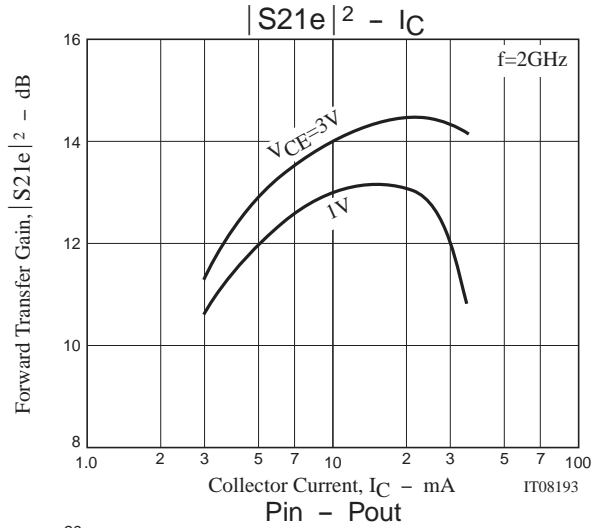
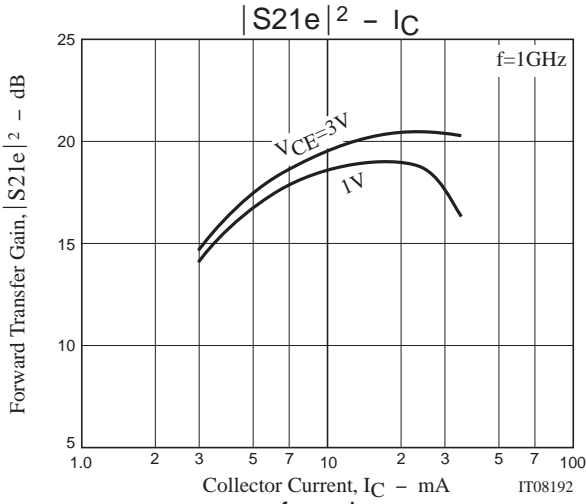

SPICE PARAMETERS

model : Gummel-Poon

Parameter	Value	Unit	Parameter	Value	Unit
IS	124.2a	A	TF	4.500p	S
BF	168.7		XTF	10.00m	
NF	1.007		VTF	8	V
VAF	5.762	V	ITF	549.7m	A
IKF	141.1m	A	PTF	25	°C
ISE	181.0f	A	CJC	168.1f	F
NE	2.295		VJC	165.7m	V
BR	11.54		MJC	571.4m	
NR	1		XCJC	330.0m	
VAR	3.43	V	TR	10.00p	S
IKR	21.00m	A	FC	800.0m	
ISC	1.800f	A	CJS	0	F
NC	1.24		VJS	0	V
RB	2.86	Ω	MJS	0	
IRB	100.0μ	A	LE	415.0p	F
RBM	1.254	Ω	LB	2.300n	F
RE	1.297	Ω	LC	989.3p	F
RC	2.552	Ω	Cbc	20.00f	F
XTB	0		Cce	505.0f	F
EG	1.11	eV	Cbe	320.0f	F
XTI	3		CCB	212.0f	H
CJE	98.40f	F	CEC	580.0f	H
VJE	10	V	CEB	320.0f	H
MJE	100.0m				

SCHEMATIC

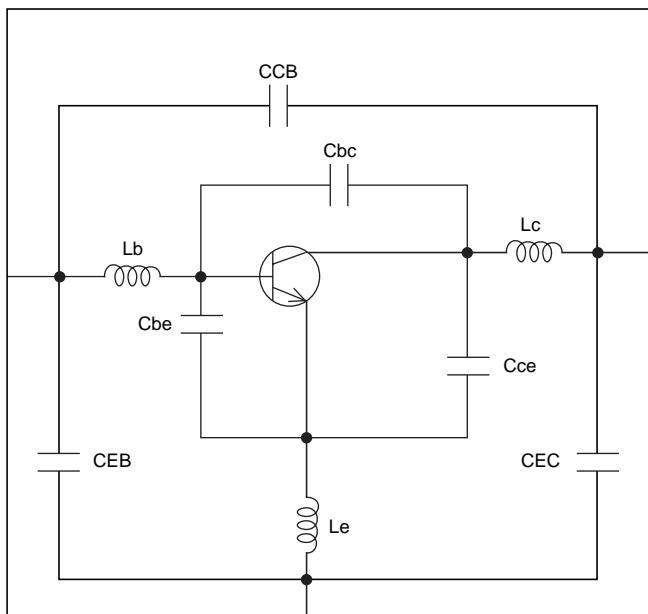

IT08199

*Information (including circuit diagrams and circuit parameters) herein is for example only ; it is not guaranteed for volume production.

S Parameters (Common emitter) $V_{CE}=1V, I_C=5mA, Z_0=50\Omega$

Freq(MHz)	$ S_{11} $	$\angle S_{11}$	$ S_{21} $	$\angle S_{21}$	$ S_{12} $	$\angle S_{12}$	$ S_{22} $	$\angle S_{22}$
200	0.886	-19.6	9.563	159.2	0.025	82.2	0.952	-19.4
400	0.809	-41.9	9.578	140.5	0.050	70.9	0.878	-37.7
600	0.740	-61.1	8.407	127.4	0.069	61.5	0.778	-53.8
800	0.651	-79.0	7.402	115.0	0.083	54.0	0.688	-66.5
1000	0.563	-99.0	6.862	103.9	0.092	49.4	0.609	-76.5
1200	0.498	-115.3	6.118	95.0	0.098	46.1	0.551	-84.9
1400	0.462	-127.2	5.350	88.4	0.105	43.8	0.508	-91.9
1600	0.429	-140.6	4.833	82.0	0.111	42.4	0.474	-98.0
1800	0.408	-151.5	4.359	76.5	0.116	41.3	0.449	-103.5
2000	0.397	-161.6	3.961	71.5	0.121	40.6	0.431	-108.7
2200	0.389	-170.0	3.610	67.1	0.126	39.9	0.418	-112.8
2400	0.386	-178.9	3.336	62.6	0.131	39.7	0.407	-117.2
2600	0.383	173.8	3.085	58.6	0.136	39.4	0.400	-121.0
2800	0.386	167.1	2.868	54.7	0.141	39.1	0.396	-124.5
3000	0.388	160.7	2.688	51.1	0.148	38.9	0.396	-127.6
3200	0.395	154.9	2.527	47.5	0.154	38.7	0.398	-130.9
3400	0.402	149.4	2.387	43.9	0.160	38.0	0.400	-133.9
3600	0.410	144.1	2.262	40.5	0.166	37.7	0.404	-137.0
3800	0.418	139.4	2.148	37.1	0.173	37.2	0.408	-139.9
4000	0.427	134.8	2.042	33.8	0.180	36.6	0.414	-142.8
4200	0.436	130.4	1.947	30.6	0.186	35.8	0.419	-145.6
4400	0.445	126.3	1.861	27.4	0.193	35.1	0.426	-148.2
4600	0.454	122.4	1.780	24.3	0.200	34.1	0.432	-150.8
4800	0.463	118.6	1.707	21.3	0.207	33.1	0.439	-153.3
5000	0.472	114.9	1.638	18.3	0.214	32.3	0.447	-155.9
5200	0.481	111.4	1.573	15.4	0.221	31.2	0.453	-158.5
5400	0.490	108.0	1.514	12.6	0.228	30.2	0.461	-160.9
5600	0.498	104.8	1.458	9.8	0.236	29.1	0.468	-163.2
5800	0.504	101.5	1.406	7.2	0.243	28.0	0.475	-165.4
6000	0.511	98.4	1.359	4.5	0.251	26.9	0.482	-167.5

S Parameters (Common emitter) $V_{CE}=1V, I_C=10mA, Z_0=50\Omega$

Freq(MHz)	$ S_{11} $	$\angle S_{11}$	$ S_{21} $	$\angle S_{21}$	$ S_{12} $	$\angle S_{12}$	$ S_{22} $	$\angle S_{22}$
200	0.779	-30.7	15.686	152.1	0.023	77.6	0.898	-26.9
400	0.673	-61.6	14.941	130.3	0.043	66.7	0.769	-49.4
600	0.573	-89.0	12.508	113.8	0.056	59.5	0.643	-66.7
800	0.497	-109.9	10.142	102.2	0.066	55.9	0.548	-79.3
1000	0.444	-127.9	8.487	93.4	0.074	54.2	0.480	-88.9
1200	0.412	-142.8	7.217	86.5	0.082	52.7	0.434	-97.0
1400	0.396	-154.4	6.226	81.0	0.089	52.4	0.403	-103.5
1600	0.386	-165.1	5.481	76.0	0.097	51.7	0.381	-109.1
1800	0.381	-174.2	4.886	71.6	0.105	51.5	0.366	-114.4
2000	0.382	177.5	4.404	67.4	0.112	50.7	0.356	-119.3
2200	0.382	170.1	4.001	63.6	0.120	50.3	0.349	-123.1
2400	0.386	163.2	3.673	59.8	0.128	49.5	0.345	-127.2
2600	0.389	157.1	3.389	56.3	0.135	48.8	0.343	-130.7
2800	0.396	151.5	3.147	52.9	0.143	48.0	0.344	-134.0
3000	0.400	146.3	2.938	49.6	0.152	47.4	0.346	-136.8
3200	0.409	141.6	2.762	46.4	0.160	46.4	0.350	-139.8
3400	0.417	137.1	2.605	43.2	0.168	45.3	0.356	-142.5
3600	0.426	132.6	2.463	40.0	0.177	44.2	0.362	-145.3
3800	0.435	128.6	2.339	37.0	0.184	43.0	0.368	-148.0
4000	0.444	124.7	2.223	33.9	0.192	41.8	0.375	-150.6
4200	0.452	120.9	2.119	31.0	0.200	40.5	0.381	-153.1
4400	0.461	117.3	2.025	28.0	0.208	39.2	0.389	-155.6
4600	0.469	114.0	1.936	25.1	0.216	37.7	0.396	-157.9
4800	0.477	110.6	1.858	22.3	0.224	36.3	0.403	-160.2
5000	0.485	107.3	1.782	19.5	0.231	34.9	0.411	-162.6
5200	0.493	104.1	1.713	16.7	0.239	33.3	0.418	-164.9
5400	0.500	101.1	1.649	14.0	0.246	32.0	0.425	-167.1
5600	0.507	98.1	1.590	11.5	0.254	30.5	0.432	-169.1
5800	0.513	95.2	1.537	8.9	0.261	29.0	0.439	-171.0
6000	0.518	92.3	1.485	6.4	0.269	27.5	0.447	-172.9

S Parameters (Common emitter) $V_{CE}=1V, I_C=15mA, Z_0=50\Omega$

Freq(MHz)	$ S_{11} $	$\angle S_{11}$	$ S_{21} $	$\angle S_{21}$	$ S_{12} $	$\angle S_{12}$	$ S_{22} $	$\angle S_{22}$
200	0.663	-45.9	18.500	145.2	0.022	76.5	0.850	-31.9
400	0.568	-79.6	17.444	122.6	0.039	64.9	0.690	-56.0
600	0.486	-107.3	13.861	106.6	0.049	60.2	0.562	-73.2
800	0.439	-127.6	10.864	96.4	0.059	58.9	0.476	-85.6
1000	0.410	-143.4	8.868	89.0	0.068	58.1	0.419	-94.9
1200	0.395	-156.5	7.457	83.0	0.077	57.8	0.382	-102.7
1400	0.388	-166.8	6.401	78.1	0.085	57.4	0.358	-109.2
1600	0.387	-176.2	5.611	73.6	0.094	56.6	0.342	-114.6
1800	0.387	175.9	4.990	69.6	0.102	56.2	0.332	-119.7
2000	0.392	168.6	4.492	65.6	0.111	55.3	0.326	-124.5
2200	0.394	162.1	4.077	62.1	0.120	54.4	0.323	-128.1
2400	0.400	156.0	3.738	58.5	0.128	53.3	0.321	-132.1
2600	0.404	150.6	3.447	55.1	0.136	52.6	0.322	-135.2
2800	0.412	145.5	3.199	51.9	0.146	51.5	0.324	-138.4
3000	0.417	140.7	2.987	48.8	0.154	50.4	0.328	-141.0
3200	0.426	136.5	2.806	45.6	0.163	49.1	0.334	-143.8
3400	0.434	132.3	2.644	42.6	0.172	47.8	0.340	-146.4
3600	0.443	128.3	2.501	39.6	0.181	46.6	0.348	-149.1
3800	0.451	124.5	2.373	36.6	0.189	45.1	0.354	-151.7
4000	0.460	120.9	2.256	33.6	0.198	43.8	0.362	-154.1
4200	0.468	117.3	2.150	30.8	0.206	42.3	0.369	-156.5
4400	0.476	114.0	2.053	27.9	0.214	40.6	0.377	-158.8
4600	0.484	110.8	1.964	25.1	0.223	39.1	0.384	-161.0
4800	0.492	107.6	1.885	22.3	0.230	37.5	0.391	-163.2
5000	0.500	104.4	1.809	19.6	0.238	35.9	0.400	-165.4
5200	0.506	101.4	1.738	16.9	0.246	34.3	0.407	-167.7
5400	0.513	98.4	1.675	14.3	0.253	32.8	0.415	-169.8
5600	0.519	95.6	1.616	11.8	0.261	31.1	0.421	-171.8
5800	0.525	92.7	1.560	9.2	0.269	29.6	0.428	-173.6
6000	0.530	89.9	1.509	6.8	0.277	28.0	0.436	-175.5

S Parameters (Common emitter) $V_{CE}=1V, I_C=20mA, Z_0=50\Omega$

Freq(MHz)	$ S_{11} $	$\angle S_{11}$	$ S_{21} $	$\angle S_{21}$	$ S_{12} $	$\angle S_{12}$	$ S_{22} $	$\angle S_{22}$
200	0.571	-63.5	19.420	139.4	0.022	73.7	0.804	-35.4
400	0.502	-97.2	17.635	117.0	0.035	65.6	0.629	-60.2
600	0.448	-121.0	13.965	102.5	0.046	62.1	0.508	-77.3
800	0.422	-139.6	10.852	93.2	0.055	61.1	0.432	-89.3
1000	0.405	-153.5	8.819	86.5	0.064	61.0	0.382	-98.5
1200	0.397	-165.0	7.402	81.0	0.074	60.7	0.351	-106.0
1400	0.396	-174.3	6.343	76.4	0.083	60.1	0.332	-112.5
1600	0.397	177.3	5.553	72.1	0.092	59.5	0.319	-117.7
1800	0.400	170.3	4.937	68.3	0.102	58.9	0.313	-122.6
2000	0.406	163.7	4.440	64.4	0.110	57.5	0.309	-127.3
2200	0.410	157.6	4.031	61.0	0.120	56.9	0.308	-130.8
2400	0.416	152.1	3.695	57.5	0.129	55.6	0.308	-134.6
2600	0.421	146.9	3.405	54.2	0.138	54.5	0.310	-137.7
2800	0.429	142.3	3.160	51.1	0.146	53.3	0.313	-140.8
3000	0.435	137.8	2.950	48.0	0.156	52.1	0.319	-143.2
3200	0.443	133.7	2.770	44.9	0.165	50.7	0.325	-145.9
3400	0.452	129.8	2.611	41.9	0.175	49.4	0.332	-148.4
3600	0.460	126.0	2.469	39.0	0.183	47.8	0.340	-151.0
3800	0.469	122.4	2.342	36.0	0.192	46.2	0.347	-153.4
4000	0.477	119.0	2.226	33.1	0.201	44.7	0.356	-155.8
4200	0.485	115.4	2.121	30.3	0.209	43.0	0.363	-158.0
4400	0.492	112.2	2.028	27.4	0.217	41.4	0.371	-160.4
4600	0.500	109.1	1.939	24.7	0.226	39.9	0.379	-162.5
4800	0.507	106.1	1.860	21.9	0.234	38.2	0.386	-164.8
5000	0.515	103.0	1.784	19.2	0.242	36.5	0.395	-166.8
5200	0.521	99.9	1.716	16.6	0.250	34.9	0.403	-169.1
5400	0.528	97.1	1.653	14.0	0.258	33.3	0.410	-171.0
5600	0.534	94.3	1.595	11.5	0.265	31.6	0.418	-173.1
5800	0.539	91.5	1.541	9.0	0.272	30.0	0.424	-174.9
6000	0.791	145.7	0.122	-69.1	0.122	-69.0	0.898	-158.6

S Parameters (Common emitter) $V_{CE}=1V, I_C=25mA, Z_O=50\Omega$

Freq(MHz)	$ S_{11} $	$\angle S_{11}$	$ S_{21} $	$\angle S_{21}$	$ S_{12} $	$\angle S_{12}$	$ S_{22} $	$\angle S_{22}$
200	0.518	-80.0	19.415	135.0	0.021	73.2	0.762	-38.4
400	0.475	-112.6	16.674	113.0	0.034	65.1	0.580	-63.2
600	0.440	-132.4	13.356	99.8	0.044	62.3	0.466	-80.0
800	0.425	-148.8	10.399	91.1	0.054	62.7	0.397	-91.8
1000	0.414	-160.9	8.489	84.9	0.063	62.7	0.354	-100.9
1200	0.410	-171.0	7.152	79.6	0.073	62.4	0.329	-108.4
1400	0.412	-179.6	6.123	75.1	0.082	61.8	0.312	-114.6
1600	0.415	172.8	5.367	71.0	0.092	60.9	0.303	-119.7
1800	0.418	166.4	4.778	67.2	0.101	60.1	0.299	-124.5
2000	0.425	160.3	4.297	63.4	0.111	59.1	0.296	-129.1
2200	0.430	154.6	3.898	60.0	0.120	57.9	0.297	-132.4
2400	0.436	149.4	3.574	56.5	0.129	56.8	0.299	-136.1
2600	0.441	144.6	3.294	53.3	0.138	55.7	0.301	-139.2
2800	0.450	140.2	3.056	50.1	0.148	54.3	0.306	-142.0
3000	0.455	135.9	2.853	47.1	0.157	53.0	0.312	-144.5
3200	0.463	132.0	2.680	44.0	0.166	51.5	0.319	-147.1
3400	0.471	128.2	2.527	41.0	0.175	50.1	0.327	-149.4
3600	0.480	124.5	2.390	38.1	0.185	48.5	0.335	-151.9
3800	0.488	121.0	2.267	35.1	0.193	46.9	0.344	-154.4
4000	0.496	117.7	2.154	32.2	0.202	45.2	0.352	-156.7
4200	0.504	114.3	2.052	29.4	0.211	43.7	0.360	-158.9
4400	0.511	111.1	1.961	26.5	0.219	41.9	0.368	-161.3
4600	0.518	108.0	1.876	23.8	0.228	40.4	0.377	-163.4
4800	0.526	105.0	1.800	21.0	0.236	38.6	0.384	-165.5
5000	0.533	102.0	1.727	18.4	0.244	36.9	0.393	-167.6
5200	0.539	99.0	1.660	15.7	0.252	35.2	0.401	-169.9
5400	0.546	96.2	1.600	13.2	0.260	33.5	0.409	-171.8
5600	0.551	93.4	1.543	10.7	0.267	31.9	0.416	-173.7
5800	0.556	90.6	1.491	8.2	0.275	30.1	0.423	-175.6
6000	0.560	87.8	1.441	5.7	0.283	28.6	0.430	-177.4

S Parameters (Common emitter) $V_{CE}=3V, I_C=5mA, Z_0=50\Omega$

Freq(MHz)	$ S_{11} $	$\angle S_{11}$	$ S_{21} $	$\angle S_{21}$	$ S_{12} $	$\angle S_{12}$	$ S_{22} $	$\angle S_{22}$
200	0.902	-16.9	9.926	160.8	0.020	84.3	0.965	-16.2
400	0.841	-36.5	10.048	143.1	0.040	78.0	0.911	-32.1
600	0.779	-53.1	8.776	130.8	0.058	68.7	0.823	-46.8
800	0.688	-69.7	7.912	118.3	0.072	60.7	0.736	-58.5
1000	0.591	-88.5	7.495	107.1	0.082	55.3	0.656	-67.8
1200	0.515	-103.8	6.736	98.0	0.089	51.8	0.594	-75.5
1400	0.470	-115.0	5.914	91.4	0.095	48.9	0.546	-82.0
1600	0.422	-128.6	5.391	84.6	0.100	47.7	0.507	-87.6
1800	0.394	-139.8	4.875	79.0	0.106	46.4	0.479	-92.8
2000	0.374	-150.1	4.434	73.9	0.111	45.5	0.458	-97.3
2200	0.361	-159.3	4.051	69.4	0.116	45.0	0.441	-101.6
2400	0.352	-168.9	3.750	64.9	0.122	44.4	0.428	-105.6
2600	0.346	-176.7	3.466	60.8	0.127	44.4	0.419	-109.2
2800	0.345	175.8	3.226	57.0	0.132	44.0	0.413	-112.5
3000	0.345	168.8	3.024	53.3	0.138	43.8	0.411	-115.8
3200	0.350	162.3	2.843	49.6	0.144	43.5	0.412	-119.0
3400	0.356	156.3	2.688	46.1	0.151	43.2	0.413	-122.2
3600	0.364	150.5	2.548	42.6	0.158	42.7	0.416	-125.4
3800	0.372	145.2	2.417	39.2	0.164	42.1	0.419	-128.4
4000	0.381	140.3	2.300	35.8	0.171	41.6	0.424	-131.4
4200	0.389	135.5	2.193	32.6	0.178	40.8	0.429	-134.3
4400	0.398	131.0	2.095	29.3	0.185	40.0	0.435	-137.2
4600	0.408	126.9	2.004	26.2	0.192	39.2	0.441	-140.0
4800	0.417	122.7	1.920	23.1	0.199	38.2	0.449	-142.8
5000	0.427	119.0	1.842	20.1	0.206	37.1	0.456	-145.3
5200	0.437	115.3	1.768	17.2	0.214	36.2	0.463	-148.1
5400	0.445	111.7	1.700	14.3	0.221	35.2	0.470	-150.7
5600	0.454	108.4	1.636	11.5	0.228	34.0	0.476	-153.2
5800	0.462	105.0	1.577	8.8	0.236	33.1	0.484	-155.5
6000	0.470	101.9	1.524	6.2	0.244	31.9	0.492	-157.8

S Parameters (Common emitter) $V_{CE}=3V, I_C=10mA, Z_O=50\Omega$

Freq(MHz)	$ S_{11} $	$\angle S_{11}$	$ S_{21} $	$\angle S_{21}$	$ S_{12} $	$\angle S_{12}$	$ S_{22} $	$\angle S_{22}$
200	0.821	-23.6	16.540	155.6	0.018	82.5	0.929	-21.2
400	0.727	-50.3	15.780	134.6	0.036	73.8	0.832	-40.5
600	0.624	-74.0	13.461	118.6	0.049	67.3	0.714	-56.1
800	0.528	-93.7	11.167	106.3	0.059	61.9	0.613	-67.7
1000	0.450	-112.1	9.502	96.7	0.067	59.1	0.536	-76.4
1200	0.401	-127.3	8.122	89.3	0.075	57.3	0.481	-83.4
1400	0.372	-139.4	7.029	83.7	0.083	56.5	0.442	-89.4
1600	0.351	-151.3	6.206	78.5	0.090	55.8	0.414	-94.6
1800	0.339	-161.6	5.540	73.9	0.097	55.2	0.393	-99.4
2000	0.333	-171.0	4.999	69.6	0.104	54.5	0.378	-103.8
2200	0.331	-179.5	4.545	65.7	0.112	53.5	0.368	-107.7
2400	0.332	172.5	4.175	61.9	0.120	53.2	0.361	-111.7
2600	0.332	165.5	3.851	58.3	0.127	52.6	0.356	-115.1
2800	0.337	159.1	3.578	54.9	0.134	51.9	0.354	-118.2
3000	0.342	153.3	3.341	51.7	0.142	51.0	0.355	-121.2
3200	0.349	147.9	3.140	48.4	0.150	50.0	0.358	-124.4
3400	0.357	142.8	2.962	45.1	0.158	49.0	0.362	-127.4
3600	0.366	138.1	2.803	42.0	0.166	48.1	0.367	-130.5
3800	0.376	133.5	2.658	38.9	0.174	46.9	0.373	-133.4
4000	0.386	129.4	2.528	35.8	0.182	45.6	0.378	-136.3
4200	0.395	125.3	2.408	32.8	0.190	44.5	0.385	-139.1
4400	0.404	121.4	2.300	29.8	0.198	43.2	0.392	-141.8
4600	0.413	117.9	2.200	26.9	0.205	41.9	0.399	-144.5
4800	0.422	114.3	2.108	24.0	0.213	40.5	0.407	-147.1
5000	0.430	110.9	2.022	21.1	0.221	39.0	0.414	-149.5
5200	0.439	107.7	1.943	18.4	0.229	37.8	0.422	-152.1
5400	0.447	104.5	1.869	15.7	0.236	36.3	0.429	-154.5
5600	0.455	101.4	1.801	13.0	0.244	34.9	0.436	-156.8
5800	0.461	98.4	1.738	10.4	0.252	33.5	0.443	-158.9
6000	0.468	95.5	1.680	7.8	0.259	32.0	0.451	-161.1

S Parameters (Common emitter) $V_{CE}=3V, I_C=15mA, Z_0=50\Omega$

Freq(MHz)	$ S_{11} $	$\angle S_{11}$	$ S_{21} $	$\angle S_{21}$	$ S_{12} $	$\angle S_{12}$	$ S_{22} $	$\angle S_{22}$
200	0.741	-29.7	21.968	151.6	0.017	81.0	0.898	-24.5
400	0.626	-61.9	19.649	128.0	0.032	73.0	0.773	-45.2
600	0.516	-88.7	15.734	111.1	0.044	67.8	0.643	-60.7
800	0.441	-109.1	12.475	100.0	0.054	64.3	0.544	-71.7
1000	0.390	-126.3	10.223	91.8	0.062	62.7	0.474	-80.0
1200	0.359	-140.5	8.604	85.5	0.070	62.6	0.427	-86.6
1400	0.342	-152.5	7.399	80.4	0.078	61.4	0.394	-92.3
1600	0.332	-163.3	6.483	75.8	0.086	60.5	0.371	-97.4
1800	0.328	-172.8	5.768	71.6	0.095	59.7	0.355	-101.9
2000	0.328	178.7	5.192	67.7	0.103	58.8	0.343	-106.2
2200	0.330	171.0	4.716	64.0	0.111	57.9	0.336	-110.2
2400	0.334	163.9	4.324	60.5	0.120	57.0	0.332	-114.0
2600	0.337	157.6	3.985	57.1	0.128	56.2	0.329	-117.3
2800	0.344	151.8	3.698	53.9	0.136	55.1	0.329	-120.4
3000	0.349	146.6	3.455	50.8	0.145	54.0	0.332	-123.4
3200	0.358	141.7	3.243	47.6	0.153	52.9	0.336	-126.5
3400	0.366	137.2	3.058	44.6	0.162	51.5	0.342	-129.5
3600	0.375	132.9	2.892	41.6	0.170	50.2	0.348	-132.4
3800	0.386	128.7	2.742	38.5	0.178	49.0	0.354	-135.4
4000	0.395	124.9	2.608	35.6	0.187	47.5	0.360	-138.2
4200	0.404	121.1	2.484	32.7	0.195	46.2	0.368	-140.9
4400	0.412	117.5	2.373	29.8	0.203	44.5	0.375	-143.6
4600	0.422	114.1	2.269	26.9	0.211	43.2	0.383	-146.2
4800	0.431	110.7	2.174	24.1	0.219	41.6	0.391	-148.8
5000	0.439	107.6	2.086	21.4	0.227	40.0	0.399	-151.2
5200	0.447	104.4	2.005	18.6	0.235	38.5	0.407	-153.7
5400	0.455	101.4	1.928	16.0	0.242	36.9	0.414	-156.0
5600	0.462	98.5	1.858	13.4	0.250	35.4	0.421	-158.3
5800	0.468	95.6	1.794	10.8	0.258	33.8	0.428	-160.4
6000	0.475	92.9	1.734	8.3	0.265	32.2	0.436	-162.6

S Parameters (Common emitter) $V_{CE}=3V, I_C=20mA, Z_0=50\Omega$

Freq(MHz)	$ S_{11} $	$\angle S_{11}$	$ S_{21} $	$\angle S_{21}$	$ S_{12} $	$\angle S_{12}$	$ S_{22} $	$\angle S_{22}$
200	0.666	-35.3	26.045	148.3	0.016	80.9	0.873	-26.5
400	0.548	-71.2	21.825	123.2	0.030	73.7	0.731	-47.8
600	0.455	-98.7	16.689	106.9	0.040	69.1	0.599	-62.9
800	0.397	-119.1	12.955	96.6	0.050	67.0	0.504	-73.4
1000	0.363	-135.6	10.483	89.2	0.059	65.6	0.440	-81.3
1200	0.343	-149.2	8.764	83.4	0.067	65.2	0.397	-87.6
1400	0.333	-160.6	7.515	78.6	0.076	64.3	0.367	-93.1
1600	0.329	-170.6	6.572	74.3	0.085	63.5	0.348	-97.9
1800	0.329	-179.3	5.840	70.3	0.093	62.5	0.334	-102.4
2000	0.332	172.8	5.252	66.5	0.102	61.5	0.325	-106.6
2200	0.336	165.7	4.768	63.0	0.111	60.4	0.320	-110.6
2400	0.341	159.2	4.367	59.5	0.119	59.3	0.317	-114.3
2600	0.346	153.3	4.025	56.3	0.128	58.2	0.316	-117.7
2800	0.353	148.0	3.735	53.2	0.136	57.0	0.317	-120.8
3000	0.359	143.2	3.485	50.1	0.145	56.1	0.320	-123.6
3200	0.368	138.5	3.272	47.0	0.154	54.4	0.325	-126.7
3400	0.377	134.3	3.084	44.1	0.163	53.2	0.331	-129.6
3600	0.386	130.2	2.917	41.1	0.172	51.8	0.338	-132.6
3800	0.396	126.3	2.764	38.1	0.180	50.3	0.345	-135.6
4000	0.405	122.6	2.629	35.2	0.189	48.7	0.352	-138.4
4200	0.414	119.1	2.504	32.3	0.197	47.3	0.360	-141.1
4400	0.423	115.6	2.390	29.4	0.205	45.6	0.368	-143.7
4600	0.432	112.3	2.287	26.6	0.214	44.1	0.375	-146.4
4800	0.440	109.1	2.190	23.9	0.222	42.4	0.384	-148.9
5000	0.448	106.0	2.101	21.1	0.230	40.8	0.393	-151.3
5200	0.456	103.0	2.018	18.4	0.238	39.3	0.401	-153.8
5400	0.464	100.0	1.942	15.8	0.245	37.7	0.408	-156.2
5600	0.471	97.2	1.872	13.3	0.253	36.0	0.415	-158.5
5800	0.477	94.3	1.806	10.7	0.261	34.5	0.422	-160.6
6000	0.483	91.6	1.746	8.2	0.268	32.9	0.431	-162.7

S Parameters (Common emitter) $V_{CE}=3V, I_C=25mA, Z_0=50\Omega$

Freq(MHz)	$ S_{11} $	$\angle S_{11}$	$ S_{21} $	$\angle S_{21}$	$ S_{12} $	$\angle S_{12}$	$ S_{22} $	$\angle S_{22}$
200	0.603	-40.6	28.896	145.7	0.016	73.4	0.857	-27.7
400	0.492	-78.8	22.927	120.0	0.028	73.4	0.701	-49.1
600	0.417	-106.4	17.051	104.2	0.038	69.7	0.570	-63.6
800	0.375	-126.8	13.094	94.5	0.048	68.5	0.479	-73.6
1000	0.351	-142.6	10.532	87.5	0.057	68.3	0.419	-81.1
1200	0.339	-155.6	8.780	82.0	0.066	67.6	0.379	-87.2
1400	0.333	-166.2	7.520	77.4	0.075	66.2	0.352	-92.5
1600	0.333	-175.5	6.568	73.2	0.084	65.3	0.334	-97.3
1800	0.335	176.3	5.831	69.3	0.093	64.4	0.322	-101.7
2000	0.339	168.9	5.241	65.6	0.101	63.3	0.315	-105.7
2200	0.344	162.3	4.756	62.2	0.110	62.1	0.311	-109.7
2400	0.351	156.2	4.355	58.7	0.119	60.7	0.309	-113.4
2600	0.355	150.6	4.012	55.6	0.128	59.5	0.308	-116.7
2800	0.363	145.6	3.723	52.4	0.136	58.5	0.310	-119.8
3000	0.371	141.1	3.474	49.4	0.145	57.1	0.315	-122.7
3200	0.379	136.5	3.261	46.4	0.154	55.8	0.320	-125.8
3400	0.388	132.5	3.073	43.4	0.164	54.2	0.327	-128.8
3600	0.397	128.6	2.903	40.4	0.172	52.7	0.334	-131.7
3800	0.407	124.9	2.755	37.5	0.180	51.2	0.341	-134.7
4000	0.417	121.3	2.618	34.5	0.189	49.5	0.349	-137.7
4200	0.426	117.8	2.494	31.7	0.198	48.0	0.357	-140.3
4400	0.434	114.4	2.379	28.8	0.207	46.4	0.365	-143.0
4600	0.443	111.2	2.276	26.0	0.215	44.7	0.373	-145.6
4800	0.451	108.0	2.180	23.3	0.223	43.1	0.382	-148.2
5000	0.459	105.1	2.091	20.6	0.231	41.4	0.391	-150.7
5200	0.467	102.0	2.008	17.9	0.239	39.9	0.399	-153.2
5400	0.475	99.1	1.932	15.3	0.247	38.2	0.407	-155.7
5600	0.481	96.4	1.862	12.7	0.255	36.6	0.415	-157.9
5800	0.487	93.5	1.797	10.2	0.263	35.0	0.422	-160.0
6000	0.493	90.9	1.736	7.7	0.270	33.3	0.430	-162.2

- Specifications of any and all SANYO products described or contained herein stipulate the performance, characteristics, and functions of the described products in the independent state, and are not guarantees of the performance, characteristics, and functions of the described products as mounted in the customer's products or equipment. To verify symptoms and states that cannot be evaluated in an independent device, the customer should always evaluate and test devices mounted in the customer's products or equipment.
- SANYO Electric Co., Ltd. strives to supply high-quality high-reliability products. However, any and all semiconductor products fail with some probability. It is possible that these probabilistic failures could give rise to accidents or events that could endanger human lives, that could give rise to smoke or fire, or that could cause damage to other property. When designing equipment, adopt safety measures so that these kinds of accidents or events cannot occur. Such measures include but are not limited to protective circuits and error prevention circuits for safe design, redundant design, and structural design.
- In the event that any or all SANYO products(including technical data, services) described or contained herein are controlled under any of applicable local export control laws and regulations, such products must not be exported without obtaining the export license from the authorities concerned in accordance with the above law.
- No part of this publication may be reproduced or transmitted in any form or by any means, electronic or mechanical, including photocopying and recording, or any information storage or retrieval system, or otherwise, without the prior written permission of SANYO Electric Co., Ltd.
- Any and all information described or contained herein are subject to change without notice due to product/technology improvement, etc. When designing equipment, refer to the "Delivery Specification" for the SANYO product that you intend to use.
- Information (including circuit diagrams and circuit parameters) herein is for example only ; it is not guaranteed for volume production. SANYO believes information herein is accurate and reliable, but no guarantees are made or implied regarding its use or any infringements of intellectual property rights or other rights of third parties.

This catalog provides information as of March, 2005. Specifications and information herein are subject to change without notice.