

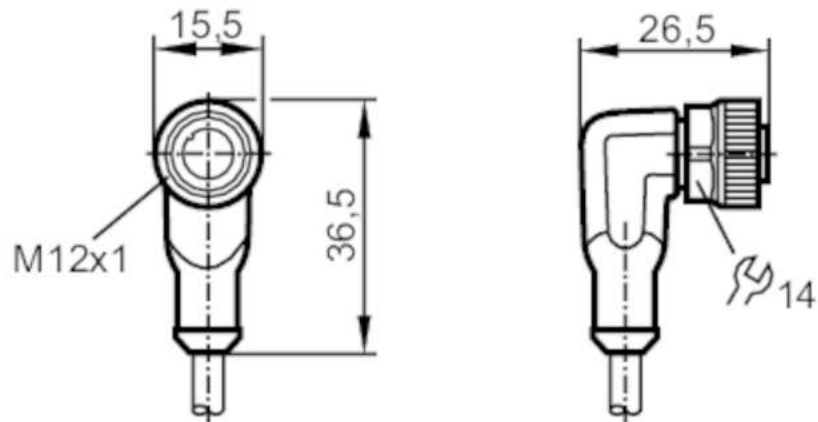

## Connecting cable with socket

ADOAH040MSS0015H04

Please see the technical note under "Downloads"



### Application

Special feature	Free from silicone; Halogen-free; Gold-plated contacts; Drag chain suitability
Free from silicone	yes

### Electrical data

Operating voltage [V]	< 250 AC / < 300 DC
Protection class	II
Max. current load total [A]	4

### Operating conditions

Ambient temperature [°C]	-25...90
Note on ambient temperature	cULus: ...75
Ambient temperature (moving) [°C]	-25...90
Note on ambient temperature (moving)	cULus: ...75
Storage temperature [°C]	-25...55
Storage humidity [%]	10...100
Other climatic conditions for storage according to stated class	1K22/ DIN 60721-3-1
Protection	IP 65; IP 67; IP 68; IP 69K

### Mechanical data

Weight [g]	425.3
Dimensions [mm]	26.5 x 15.5 x 36.5

# EVC086



## Connecting cable with socket

ADOAH040MSS0015H04

Moulded-body material	TPU	
Material nut	brass, nickel-plated	
Sealing material	FKM	
Drag chain suitability	yes	
Drag chain suitability	bending radius for flexible use	min. 10 x cable diameter
	travel speed	max. 3.3 m/s for a horizontal travel length of 5 m and max. acceleration of 5 m/s <sup>2</sup>
	bending cycles	> 5 Mio.
	torsional strain	± 180 °/m

### Remarks

Notes	Please see the technical note under "Downloads"
Pack quantity	1 pcs.

### Electrical connection

Cable: 15 m, PUR, Halogen-free, black, Ø 4.3 mm; 4 x 0.34 mm<sup>2</sup> (42 x Ø 0.1 mm )

### Electrical connection - socket

Connector: 1 x M12, angled; coding: A; Moulded body: TPU, orange; Locking: brass, nickel-plated; Sealing: FKM; Contacts: gold-plated; Tightening torque: 0.6...1.5 Nm

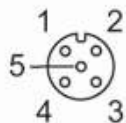

### Connection

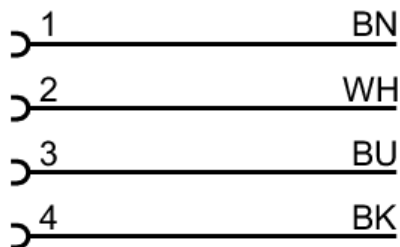

Core colours :  
 BK = black  
 BN = brown  
 BU = blue  
 WH = white



## Connecting cable with socket

ADOAH040MSS0015H04

### Diagrams and graphs

characteristic line for derating



Derating  $I_{max} * 0.8$  (DIN EN 60512-5-2)

X Ambient temperature [°C]

Y Current [A]