

# 1.8A Step-Down Regulator with Remote Sense in 2mm x 2mm WLP

## General Description

The MAX8649/MAX8649A high-efficiency DC-to-DC step-down switching regulators deliver up to 1.8A of output current. The device operates from a 2.5V to 5.5V input voltage range, making it future proof for next-generation battery technologies. The output voltage is I<sup>2</sup>C programmable from 0.75V to 1.38V. Remote sense ensures precise DC regulation at the load. Total output error is less than 2% over load, line, and temperature.

The ICs operate at a 3.25MHz fixed frequency. The high operating frequency minimizes the size of external components. The switching frequency of the converter can be synchronized to the master clock of the application. When synchronizing to an external clock, the ICs measure the frequency of the external clock to ensure that the clock is stable before changing the switching frequency to the external clock frequency.

An on-board DAC allows adjustment of the output voltage in 10mV steps. The output voltage can be programmed directly through the I<sup>2</sup>C interface, or by preloading a set of on-board registers and using the two VID logic signals to select the appropriate register. Other features include internal soft-start control circuitry to reduce inrush current, output overvoltage, overcurrent, and overtemperature protection.

The ICs feature different I<sup>2</sup>C addresses so that devices may be used in a system. For a 2.5A version of this device, refer to the MAX8952 data sheet.

## Applications

Cell Phones and Smartphones  
PDAs and MP3 Players

## Bump Configuration

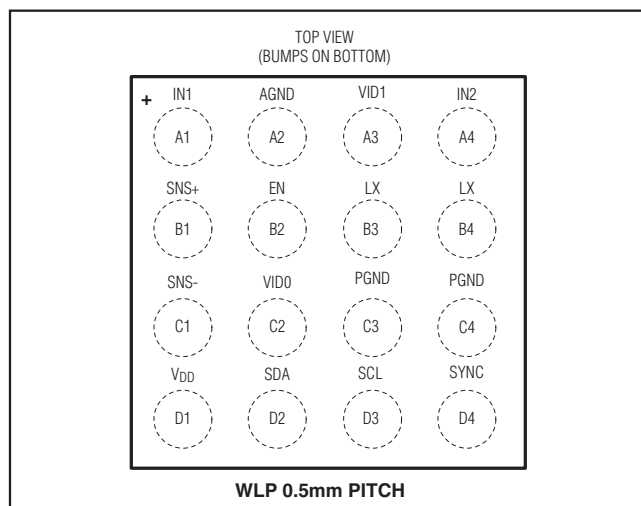

## Features

- ◆ 1.8A Guaranteed Output Current
- ◆ I<sup>2</sup>C Programmable V<sub>OUT</sub> (750mV to 1.38V in 10mV Steps)
- ◆ Operates from 2.5V to 5.5V Input Supply
- ◆ On-Chip FET and Synchronous Rectifier
- ◆ Fixed 3.25MHz PWM Switching Frequency
- ◆ Synchronizes to 13MHz, 19.2MHz, or 26MHz System Clock when Available
- ◆ Small 1.0μH Inductor
- ◆ Initial Accuracy 0.5% at 1.25V Output
- ◆ 2% Output Accuracy Over Load, Line, and Temperature
- ◆ Power-Save Mode Increases Light Load Efficiency
- ◆ Overvoltage and Overcurrent Protection
- ◆ Thermal Shutdown Protection
- ◆ 400kHz I<sup>2</sup>C Interface
- ◆ < 1μA Shutdown Current
- ◆ 16-Bump, 2mm x 2mm WLP Package

## Ordering Information

PART	PIN-PACKAGE	I <sup>2</sup> C ADDRESS (WRITE/READ)
MAX8649EWE+T	16 WLP (0.5mm pitch)	0xC0/0xC1
MAX8649AEWE+T	16 WLP (0.5mm pitch)	0xC4/0xC5

+ Denotes a lead(Pb)-free/RoHS-compliant package.

**Note:** All devices operate over the -40°C to +85°C temperature range.

## Typical Operating Circuit

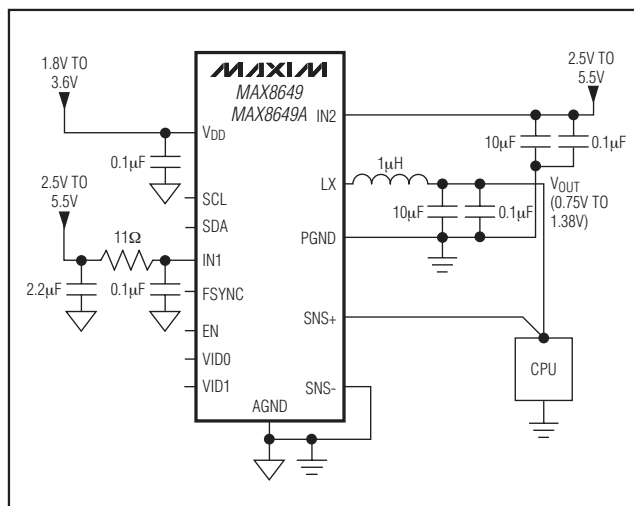

# 1.8A Step-Down Regulator with Remote Sense in 2mm x 2mm WLP

## ABSOLUTE MAXIMUM RATINGS

IN1, IN2 to AGND .....	-0.3V to +6.0V
V <sub>DD</sub> to AGND.....	-0.3V to +4.0V
LX, SNS+, VID0, VID1, EN to AGND.....	-0.3V to (V <sub>IN1</sub> + 0.3V)
SCL, SDA, SYNC to AGND.....	-0.3V to (V <sub>DD</sub> + 0.3V)
PGND, SNS- to AGND.....	-0.3V to +0.3V
RMS LX Current .....	1800mA

Continuous Power Dissipation (T <sub>A</sub> = +70°C) 16-Bump WLP 0.5mm Pitch (derate 13mW/°C above +70°C).....	1040mW
Operating Temperature Range .....	-40°C to +85°C
Junction Temperature.....	+150°C
Storage Temperature Range .....	-65°C to +150°C
Soldering Temperature (reflow) .....	+260°C

Stresses beyond those listed under "Absolute Maximum Ratings" may cause permanent damage to the device. These are stress ratings only, and functional operation of the device at these or any other conditions beyond those indicated in the operational sections of the specifications is not implied. Exposure to absolute maximum rating conditions for extended periods may affect device reliability.

## PACKAGE THERMAL CHARACTERISTICS (Note 1)

WLP

Junction to Ambient Thermal Resistance (θ<sub>JA</sub>).....76°C/W

**Note 1:** Package thermal resistances were obtained using the method described in JEDEC specification JESD51-7, using a four-layer board. For detailed information on package thermal considerations, refer to [www.maxim-ic.com/thermal-tutorial](http://www.maxim-ic.com/thermal-tutorial).

## ELECTRICAL CHARACTERISTICS

(V<sub>IN1</sub> = V<sub>IN2</sub> = 3.6V, V<sub>AGND</sub> = V<sub>PGND</sub> = 0V, V<sub>DD</sub> = 1.8V, T<sub>A</sub> = -40°C to +85°C, unless otherwise noted. Typical values are at T<sub>A</sub> = +25°C.) (Note 2)

PARAMETER	CONDITIONS		MIN	TYP	MAX	UNITS
IN1, IN2 Operating Range			2.5		5.5	V
V <sub>DD</sub> Operating Range			1.8		3.6	V
V <sub>DD</sub> Undervoltage Lockout (UVLO) Threshold	V <sub>DD</sub> falling		0.54	0.865	1.35	V
V <sub>DD</sub> UVLO Hysteresis				50		mV
IN_ Undervoltage Lockout (UVLO) Threshold	V <sub>IN</sub> falling		2.10	2.15	2.20	V
IN_ UVLO Hysteresis				70		mV
V <sub>DD</sub> Shutdown Supply Current	V <sub>IN1</sub> = V <sub>IN2</sub> = 5.5V, EN = V <sub>DD</sub> = AGND	T <sub>A</sub> = +25°C		0.01	1	μA
		T <sub>A</sub> = +85°C		0.01		
IN1, IN2 Shutdown Supply Current	V <sub>IN1</sub> = V <sub>IN2</sub> = 5.5V, EN = V <sub>DD</sub> = AGND	T <sub>A</sub> = +25°C		0.25	1	μA
		T <sub>A</sub> = +85°C		0.25		
IN1, IN2 Standby Supply Current	V <sub>IN1</sub> = V <sub>IN2</sub> = 5.5V, SCL = SDA = V <sub>DD</sub> , EN = AGND, I <sup>2</sup> C ready	T <sub>A</sub> = +25°C		0.35	1	μA
		T <sub>A</sub> = +85°C		0.35		
V <sub>DD</sub> Standby Supply Current	V <sub>IN1</sub> = V <sub>IN2</sub> = V <sub>DD</sub> = 3.6V, SCL = SDA = V <sub>DD</sub> , EN = AGND, I <sup>2</sup> C ready	T <sub>A</sub> = +25°C		0.02	1	μA
		T <sub>A</sub> = +85°C		0.02		
<b>LOGIC INTERFACE</b>						
Logic Input High Voltage (V <sub>IH</sub> )	V <sub>IN1</sub> = V <sub>IN2</sub> = 2.5V to 5.5V, V <sub>DD</sub> = 1.8V to 3.6V	EN, VID0, VID1	1.4			V
		SYNC, SCL, SDA	0.7 x V <sub>DD</sub>			
Logic Input Low Voltage (V <sub>IL</sub> )	V <sub>IN1</sub> = V <sub>IN2</sub> = 2.5V to 5.5V, V <sub>DD</sub> = 1.8V to 3.6V	EN, VID0, VID1	0.4			V
		SYNC, SCL, SDA	0.3 x V <sub>DD</sub>			
SDA, SCL, SYNC Logic Input Current	V <sub>IL</sub> = 0V or V <sub>IH</sub> = 3.6V, EN = AGND	T <sub>A</sub> = +25°C	-1	0.01	+1	μA
		T <sub>A</sub> = +85°C		0.01		

# 1.8A Step-Down Regulator with Remote Sense in 2mm x 2mm WLP

## ELECTRICAL CHARACTERISTICS (continued)

( $V_{IN1} = V_{IN2} = 3.6V$ ,  $V_{AGND} = V_{PGND} = 0V$ ,  $V_{DD} = 1.8V$ ,  $T_A = -40^{\circ}C$  to  $+85^{\circ}C$ , unless otherwise noted. Typical values are at  $T_A = +25^{\circ}C$ .) (Note 2)

PARAMETER	CONDITIONS	MIN	TYP	MAX	UNITS
VID0, VID1, EN Logic Input Pulldown Resistor	Controlled by I <sup>2</sup> C command: VID0_PD = 1 VID1_PD = 1 EN_PD = 1	200	320	450	k $\Omega$
<b>I<sup>2</sup>C INTERFACE</b>					
SDA Output Low Voltage	I <sub>SDA</sub> = 3mA		0.03	0.4	V
I <sup>2</sup> C Clock Frequency				400	kHz
Bus-Free Time Between START and STOP	t <sub>BUF</sub>	1.3			$\mu$ s
Hold Time Repeated START Condition	t <sub>HD_STA</sub>	0.6	0.1		$\mu$ s
SCL Low Period	t <sub>LOW</sub>	1.3	0.2		$\mu$ s
SCL High Period	t <sub>HIGH</sub>	0.6	0.2		$\mu$ s
Setup Time Repeated START Condition	t <sub>SU_STA</sub>	0.6	0.1		$\mu$ s
SDA Hold Time	t <sub>HD_DAT</sub>	0	-0.01		$\mu$ s
SDA Setup Time	t <sub>SU_DAT</sub>	0.1	0.05		$\mu$ s
Setup Time for STOP Condition	t <sub>SU_STO</sub>	0.6	0.1		$\mu$ s
<b>STEP-DOWN DC-DC REGULATOR</b>					
IN1 + IN2 Supply Current	OPERATION_MODE_ = 0, V <sub>OUT</sub> = 1.27V, no switching		54	70	$\mu$ A
	OPERATION_MODE_ = 1, V <sub>OUT</sub> = 1.27V, f <sub>sw</sub> = 3.25MHz		9		mA
Minimum Output Capacitance Required for Stability	V <sub>OUT</sub> = 0.75V to 1.38V, I <sub>OUT</sub> = 0 to 1.8A		10		$\mu$ F
OUT Voltage Range	10mV steps	0.750		1.380	V
Output Overvoltage Protection	Rising, 50mV hysteresis (typ)	1.65	1.8	1.9	V

MAX8649/MAX8649A

## 1.8A Step-Down Regulator with Remote Sense in 2mm x 2mm WLP

### ELECTRICAL CHARACTERISTICS (continued)

( $V_{IN1} = V_{IN2} = 3.6V$ ,  $V_{AGND} = V_{PGND} = 0V$ ,  $V_{DD} = 1.8V$ ,  $T_A = -40^{\circ}C$  to  $+85^{\circ}C$ , unless otherwise noted. Typical values are at  $T_A = +25^{\circ}C$ .) (Note 2)

PARAMETER	CONDITIONS	MIN	TYP	MAX	UNITS	
OUT Voltage Accuracy	No load, $V_{IN\_} = 2.5V$ to $5.5V$ , $V_{OUT} = 1.27V$ OPERATION_MODE_ = 1	-0.5		+0.5	%	
	$I_{OUT} =$ no load, $V_{IN\_} = 2.5V$ to $5.5V$ , $V_{OUT} = 0.75V$ , OPERATION_MODE_ = 1	-1.0		+1.0		
	$I_{OUT} =$ no load, $V_{IN\_} = 2.5V$ to $5.5V$ , $V_{OUT} = 1.38V$ , OPERATION_MODE_ = 1	-0.5		+0.5		
Load Regulation	$R_L$ is the resistance from LX to SNS+ (output)		$R_L/25$		V/A	
RAMP Timer	RAMP[2:0] = 000		32.50		mV/ $\mu$ s	
	RAMP[2:0] = 001		16.25			
	RAMP[2:0] = 010		8.125			
	RAMP[2:0] = 011		4.063			
	RAMP[2:0] = 100		2.031			
	RAMP[2:0] = 101		1.016			
	RAMP[2:0] = 110		0.508			
	RAMP[2:0] = 111		0.254			
Peak Current Limit (p-Channel MOSFET)	PWM and hysteretic mode	2.3	2.8	3.2	A	
Valley Current Limit (n-Channel MOSFET)	Hysteretic mode	1.8	2.4	3.0	A	
Negative Current Limit (n-Channel MOSFET)	PWM mode	2.0	2.5	3.0	A	
n-Channel Zero-Crossing Threshold			50		mA	
LX pFET On-Resistance	IN2 to LX, $I_{LX} = -200mA$		0.08	0.16	$\Omega$	
LX nFET On-Resistance	OPERATION_MODE = 0 LX to PGND, $I_{LX} = 200mA$		0.06	0.12	$\Omega$	
LX Leakage	$V_{LX} = 5.5V$ or $0V$	$T_A = +25^{\circ}C$	-1	0.03	+1	$\mu$ A
		$T_A = +85^{\circ}C$		0.05		
Operating Frequency	Internal oscillator, PWM	2.82	3.25	3.56	MHz	
	Internal oscillator, power-save mode before entering PWM mode	2.43	3.25	4.06		
	13MHz option		$f_{SYNC}/4$			
	19.2MHz option		$f_{SYNC}/6$			
	26MHz option		$f_{SYNC}/8$			

# 1.8A Step-Down Regulator with Remote Sense in 2mm x 2mm WLP

MAX8649/MAX8649A

## ELECTRICAL CHARACTERISTICS (continued)

( $V_{IN1} = V_{IN2} = 3.6V$ ,  $V_{AGND} = V_{PGND} = 0V$ ,  $V_{DD} = 1.8V$ ,  $T_A = -40^{\circ}C$  to  $+85^{\circ}C$ , unless otherwise noted. Typical values are at  $T_A = +25^{\circ}C$ .) (Note 2)

PARAMETER	CONDITIONS	MIN	TYP	MAX	UNITS
Minimum Duty Cycle	Forced PWM mode only, minimum duty cycle in (OPERATION_MODE_ = 1) = 0%			16	%
Maximum Duty Cycle		60			%
Minimum On- and Off-Time		30	40	50	ns
OUT Discharge Resistance	During shutdown or UVLO, from SNS+ to PGND		650		$\Omega$
SNS+, SNS- Input Impedance	$V_{OUT} = 0.75V$ (OUT_MODEx [5:0] = 0b000000)	400	600	850	k $\Omega$
Time Delay from PWM to Power-Save Mode	Time required for error amplifier to stabilize before switching mode		70		$\mu s$
Time Delay from Power-Save Mode to PWM	Time required for error amplifier to stabilize before switching mode		140		$\mu s$
<b>SYNCHRONIZATION (SYNC)</b>					
SYNC Capture Range	SYNC = 00 default	18.9	26.0	38.0	MHz
	SYNC = 1X default	14.2	19.2	28.5	
	SYNC = 01 default	9.5	13.0	19.0	
SYNC Pulse Width			13		ns
<b>PROTECTION CIRCUITS</b>					
Thermal-Shutdown Hysteresis			20		$^{\circ}C$
Thermal Shutdown			+160		$^{\circ}C$

**Note 2:** All devices are 100% production tested at  $T_A = +25^{\circ}C$ . Limits over the operating temperature range are guaranteed by design.

# 1.8A Step-Down Regulator with Remote Sense in 2mm x 2mm WLP

## Typical Operating Characteristics

(Typical Operating Circuit,  $V_{IN1} = V_{IN2} = 3.6V$ ,  $V_{AGND} = V_{PGND} = 0V$ ,  $V_{OUT} = 1.1V$ ,  $V_{DD} = 1.8V$ ,  $T_A = +25^\circ C$ , unless otherwise noted.)

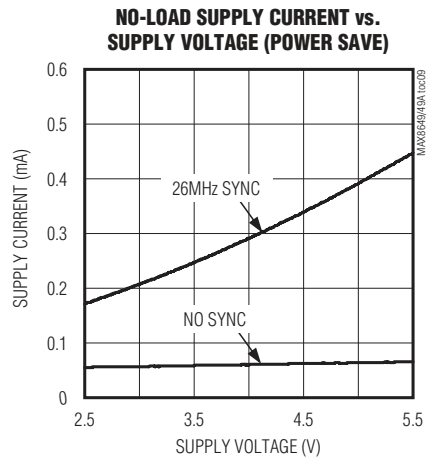
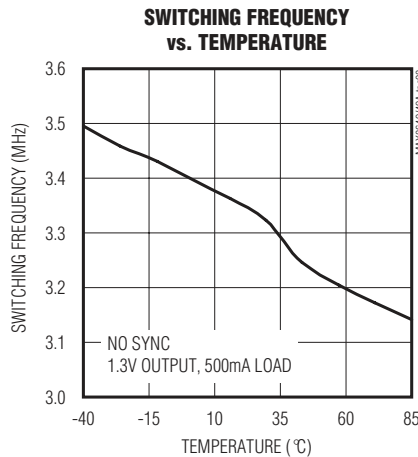
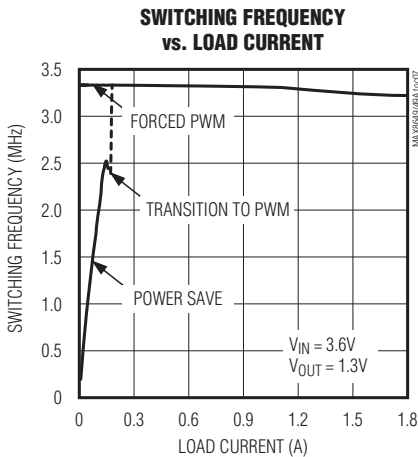
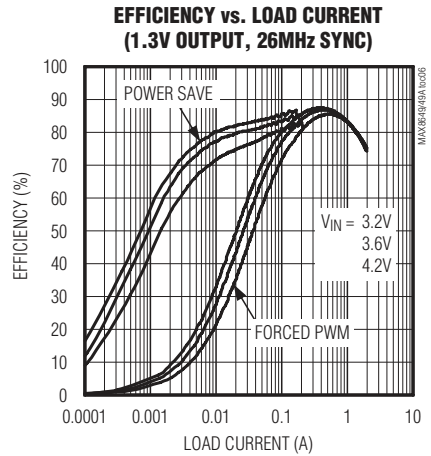
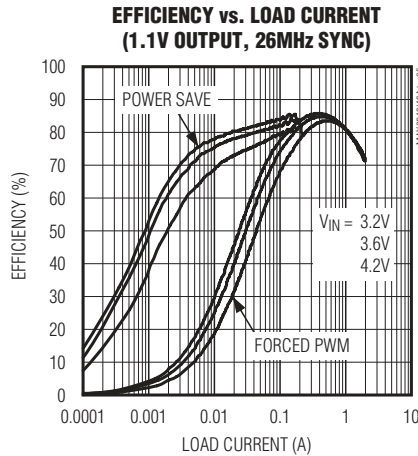
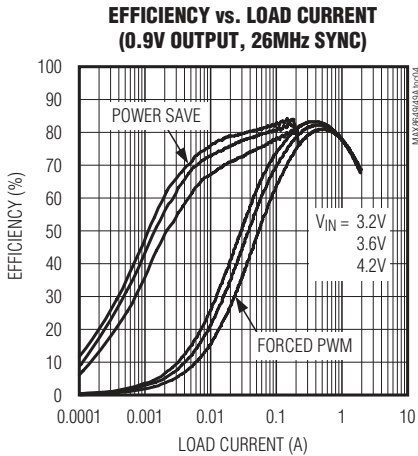
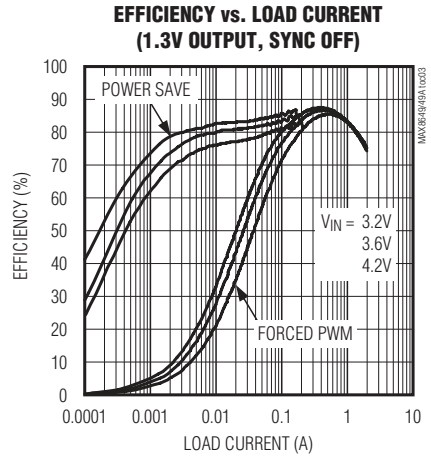
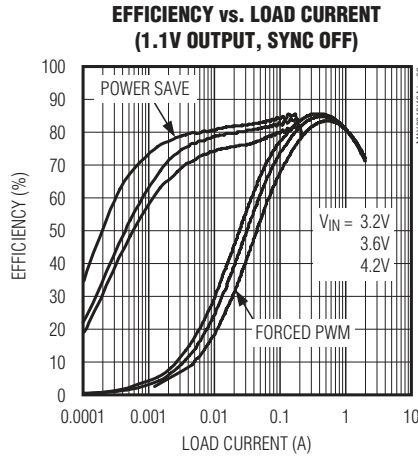
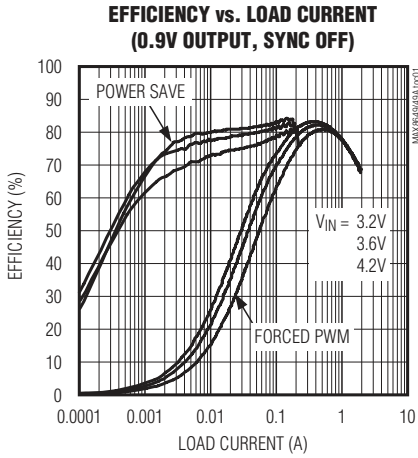

# 1.8A Step-Down Regulator with Remote Sense in 2mm x 2mm WLP

## Typical Operating Characteristics (continued)

(Typical Operating Circuit,  $V_{IN1} = V_{IN2} = 3.6V$ ,  $V_{AGND} = V_{PGND} = 0V$ ,  $V_{OUT} = 1.1V$ ,  $V_{DD} = 1.8V$ ,  $T_A = +25^\circ C$ , unless otherwise noted.)

MAX8649/MAX8649A

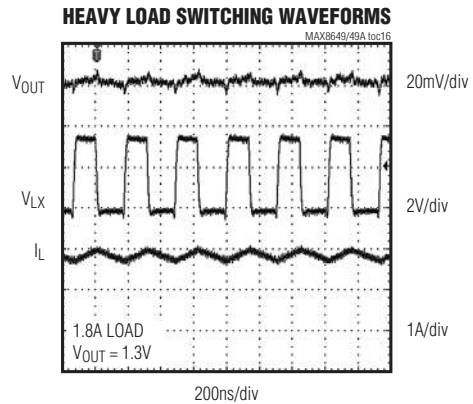
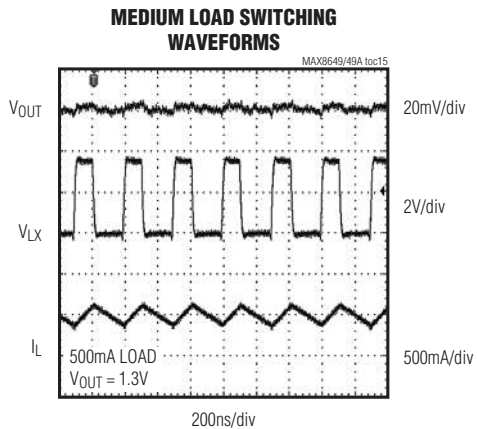
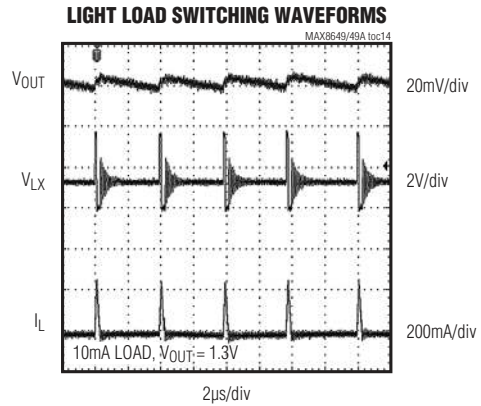
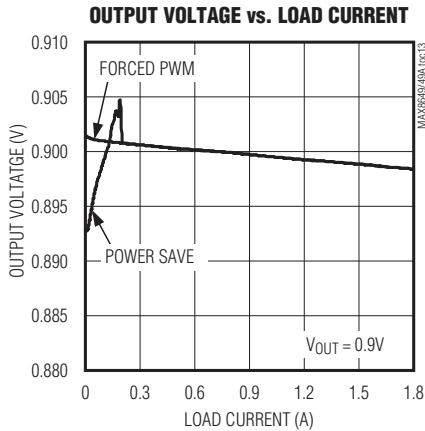
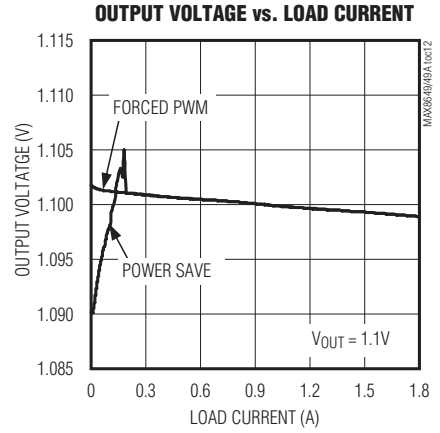
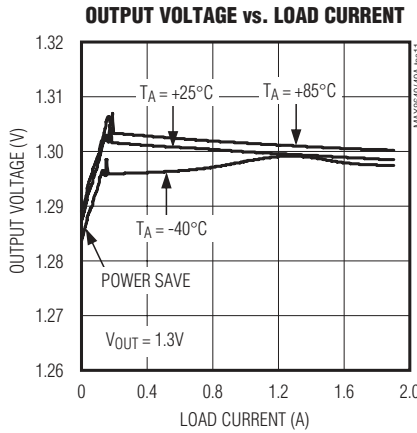
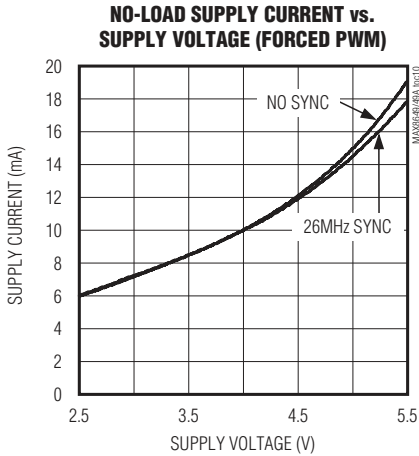

# 1.8A Step-Down Regulator with Remote Sense in 2mm x 2mm WLP

## Typical Operating Characteristics (continued)

(Typical Operating Circuit,  $V_{IN1} = V_{IN2} = 3.6V$ ,  $V_{AGND} = V_{PGND} = 0V$ ,  $V_{OUT} = 1.1V$ ,  $V_{DD} = 1.8V$ ,  $T_A = +25^\circ C$ , unless otherwise noted.)

**LIGHT LOAD STARTUP WAVEFORMS**

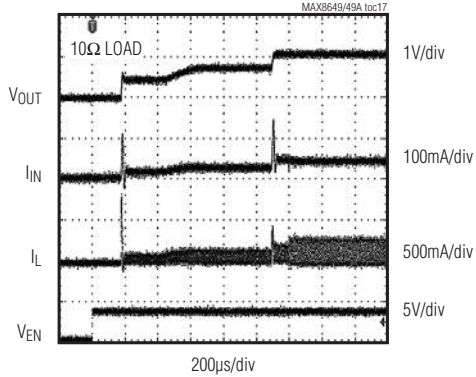

**HEAVY LOAD STARTUP WAVEFORMS**

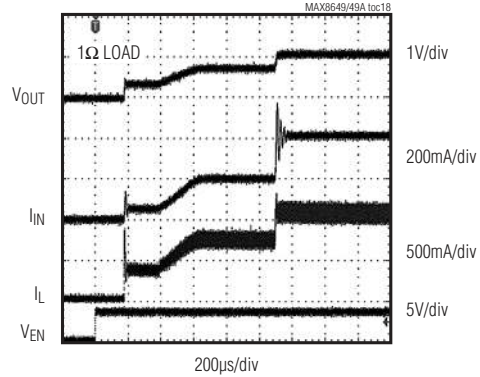

**PREBIAS STARTUP WAVEFORMS (FORCED PWM)**

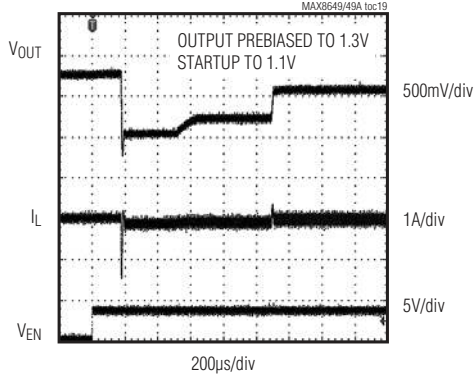

**LINE TRANSIENT RESPONSE (4.2V TO 3.2V TO 4.2V) SYNC OFF**

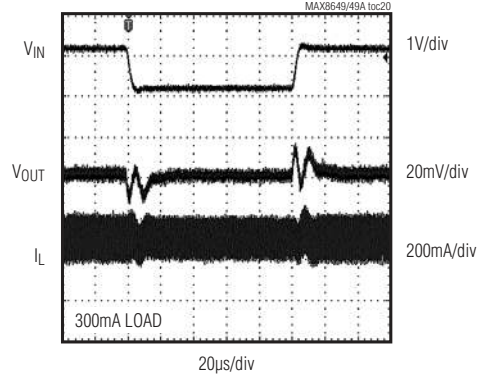

**LINE TRANSIENT RESPONSE (4.2V TO 3.2V TO 4.2V) 26MHz SYNC**

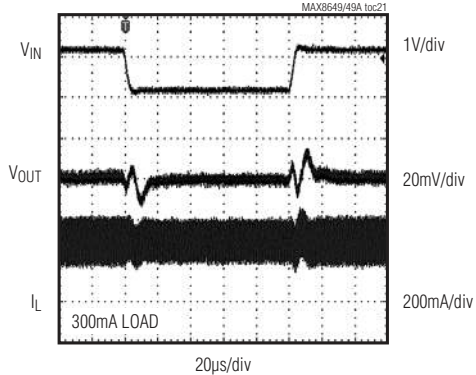

**LOAD TRANSIENT RESPONSE (1mA TO 1A)**

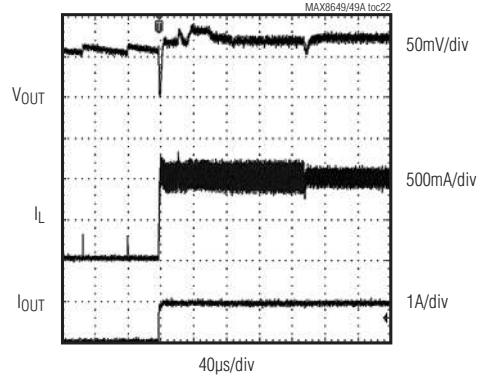



# 1.8A Step-Down Regulator with Remote Sense in 2mm x 2mm WLP

## Typical Operating Characteristics (continued)

(Typical Operating Circuit,  $V_{IN1} = V_{IN2} = 3.6V$ ,  $V_{AGND} = V_{PGND} = 0V$ ,  $V_{OUT} = 1.1V$ ,  $V_{DD} = 1.8V$ ,  $T_A = +25^\circ C$ , unless otherwise noted.)

MAX8649/MAX8649A

**LOAD TRANSIENT RESPONSE  
(1A to 1mA)**

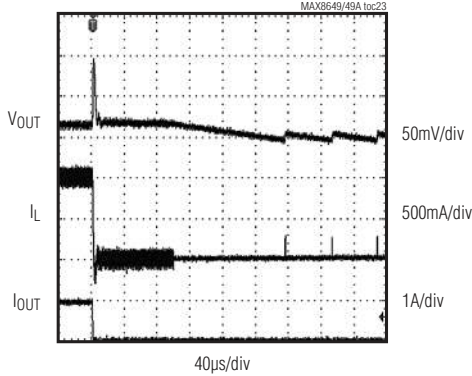

**LOAD TRANSIENT RESPONSE  
(5mA TO 1.8A)**

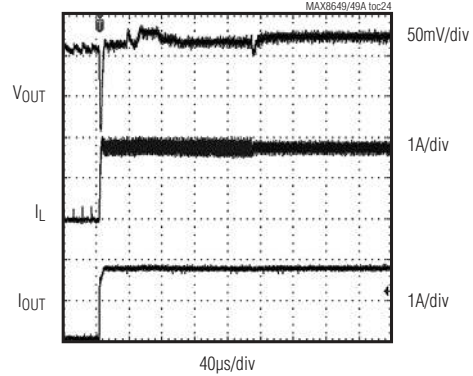

**LOAD TRANSIENT RESPONSE  
(1.8A to 5mA)**

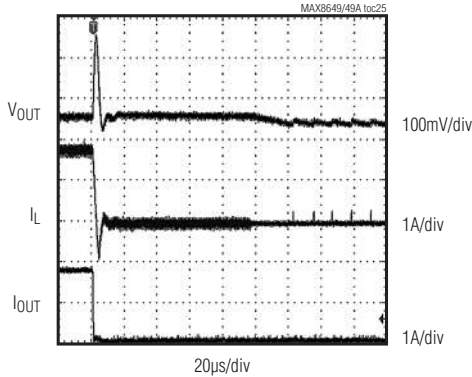

**SYNCHRONIZATION RESPONSE  
(26MHz SYNC)**

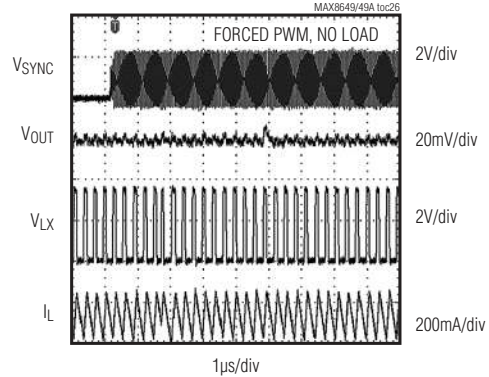

**OUTPUT VOLTAGE CHANGE RESPONSE**

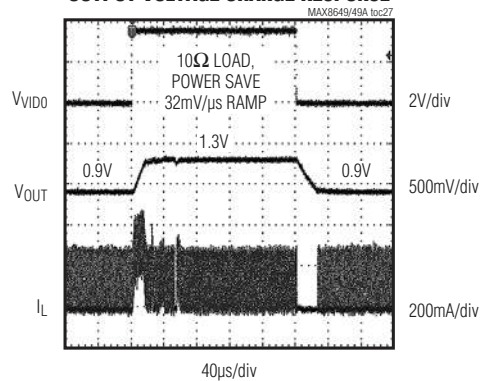

## 1.8A Step-Down Regulator with Remote Sense in 2mm x 2mm WLP

### Bump Description

PIN	NAME	FUNCTION
A1	IN1	Analog Supply Voltage Input. The input voltage range is 2.5V to 5.5V. Place an 11 $\Omega$ resistor between IN1 and the input supply. Bypass IN1 to analog ground with a 0.1 $\mu$ F ceramic capacitor as close as possible to the IC. Connect IN1 and IN2 to the same power source.
A2	AGND	Analog Ground. Connect AGND to the PCB ground plane.
A3	VID1	Voltage ID Control Input. The logic states of VID0 and VID1 select the register that sets the output voltage.
A4	IN2	Power-Supply Voltage Input. The input voltage range is from 2.5V to 5.5V. IN2 powers the internal p-channel and n-channel MOSFETs. Bypass IN2 to PGND with 10 $\mu$ F and 0.1 $\mu$ F ceramic capacitors as close as possible to the IC. Connect IN1 and IN2 to the same power source.
B1	SNS+	Output Voltage Remote Sense, Positive Input. Connect SNS+ directly to the output at the load.
B2	EN	Logic Enable Input. Drive EN high to enable the DC-DC step-down regulator, or low to place in shutdown mode. In shutdown mode, this logic input has an internal pulldown resistor to AGND.
B3, B4	LX	Inductor Connection. LX is connected to the drains of the internal p-channel and n-channel MOSFETs. LX is high impedance during shutdown.
C1	SNS-	Output Voltage Sense, Negative Input. Connect to a quiet ground directly at the IC.
C2	VID0	Voltage ID Control Input. The logic states of VID0 and VID1 select the register that sets the output voltage.
C3, C4	PGND	Power Ground. Connect both PGND bumps to the PCB ground plane.
D1	V <sub>DD</sub>	Logic Input Supply Voltage. Connect V <sub>DD</sub> to the logic supply driving SDA, SCL, and SYNC. Bypass V <sub>DD</sub> to AGND with a 0.1 $\mu$ F ceramic capacitor. When V <sub>DD</sub> drops below the UVLO threshold, the I <sup>2</sup> C registers are reset, but the EN control is still active in this mode.
D2	SDA	I <sup>2</sup> C Data Input. Data is read on the rising edge of SCL and data is clocked out on the falling edge of SCL.
D3	SCL	I <sup>2</sup> C Clock Input
D4	SYNC	External Clock Synchronization Input. Connect SYNC to a 13MHz, 19.2MHz, or 26MHz system clock. The DC-DC regulator can be forced to synchronize to this external clock depending on I <sup>2</sup> C setting. See Table 8. SYNC does not have an internal pulldown. Connect SYNC to AGND if not used.

# 1.8A Step-Down Regulator with Remote Sense in 2mm x 2mm WLP

MAX8649/MAX8649A

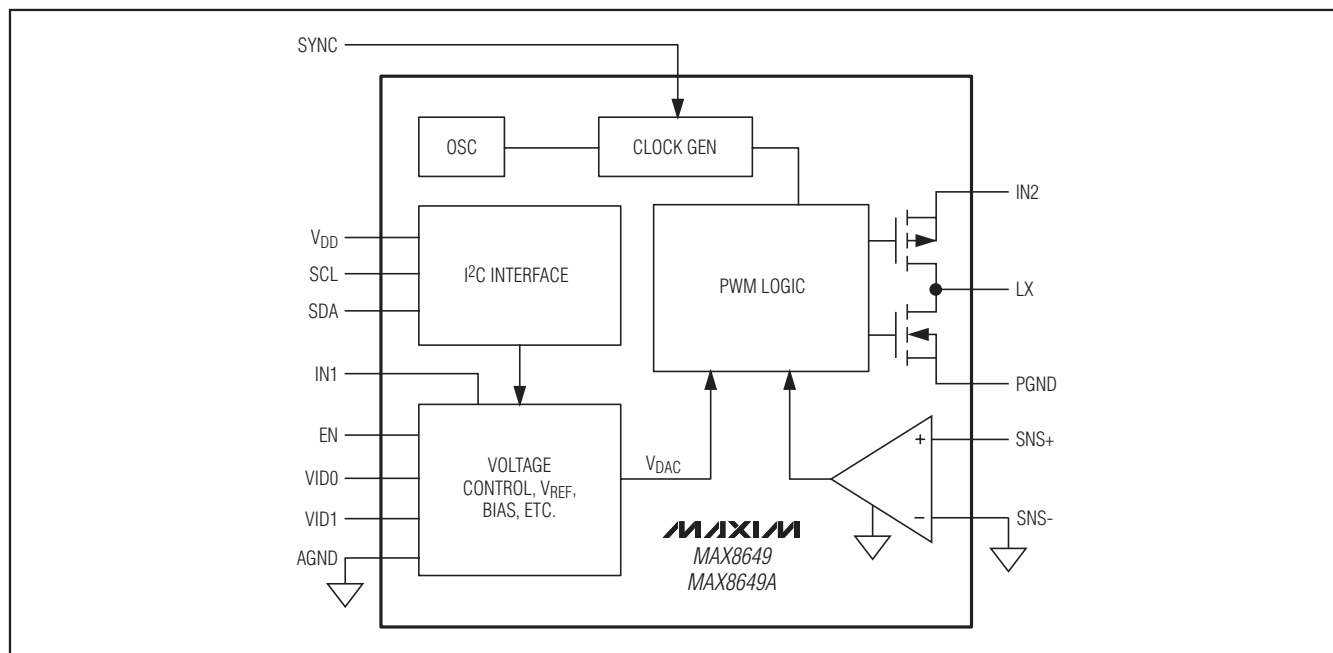

Figure 1. Block Diagram

## Detailed Description

The MAX8649/MAX8649A high-efficiency, 3.25MHz step-down switching regulator delivers up to 1.8A of output current. The device operates from a 2.5V to 5.5V input voltage range, and the output voltage is I<sup>2</sup>C programmable from 0.75V to 1.38V in 10mV increments. Remote sense ensures precise DC regulation at the load. Total output error is less than 2% over load, line, and temperature. The ICs feature different I<sup>2</sup>C addresses so that multiple devices may be used in a system (see the *Ordering Information* section.)

## Dynamic Voltage Scaling

The output voltage is dynamically adjusted by use of the VID0 and VID1 logic inputs, allowing selection between four predefined operation modes/voltage configurations.

For each of the different output modes, the following parameters are programmable:

- Output voltage from 0.75V to 1.38V in 10mV steps
- Mode of operation: Forced PWM or power save
- Enable/disable of synchronization of switching frequency to external clock source

The relation between the VID0/VID1 and operation mode is given by Table 1.

The VID\_ inputs have internal pulldown resistors. These pulldown resistors can be disabled through the CONTROL register after the ICs are enabled, achieving lowest possible quiescent current. When EN is low, the CONTROL register is reset to default, enabling the pulldown resistors (see Table 7).

Table 1. VID0 and VID1 Configuration

VID1	VID0	MODE	I <sup>2</sup> C REGISTER	DEFAULT SWITCHING MODE	DEFAULT SYNCHRONIZATION	DEFAULT OUTPUT VOLTAGE (V)
0	0	MODE0	Table 3	FORCED PWM	OFF	1.27
0	1	MODE1	Table 4	POWER SAVE	OFF	1.05
1	0	MODE2	Table 5	FORCED PWM	OFF	1.23
1	1	MODE3	Table 6	FORCED PWM	OFF	1.05

## 1.8A Step-Down Regulator with Remote Sense in 2mm x 2mm WLP

### Enable

The DC-DC step-down regulators are enabled/disabled using the EN logic input. The EN input is able to handle input voltages up to  $V_{IN1}$ , ensuring that the EN logic input can be controlled by a wide variety of signals/supplies.

The EN input has an internal pulldown resistor that ensures EN is discharged during off conditions. This pulldown resistor can be disabled through the CONTROL register (see Table 7) once the ICs are enabled, achieving lowest possible quiescent current. When EN is low, the CONTROL register is reset to default, enabling the pulldown resistors on EN, VID0, and VID1. See Figures 2 and 3 for detailed information on power-up and power-down sequencing and operation mode changes.

### DC-DC Regulator Operating Modes

The ICs operate in one of four modes determined by the state of the VID\_ inputs (see Table 1). At power-up, the ICs are default set to operate in power-save operation for MODE1 and forced-PWM mode for MODE0, MODE2, and MODE3. For each of the operation modes, MODE0 to MODE3, the DC-DC step-down regulators can be set to operate in either power-save mode or

forced-PWM mode. This is done by writing to the MODE\_ registers (see Table 3 to Table 6). The mode of operation can be changed at any time.

In power-save mode, the PWM switching frequency depends on the load current. For medium to high load condition, the ICs operate in fixed-frequency PWM mode. For light load conditions, the ICs operate in hysteretic mode. The proprietary hysteretic PWM control scheme ensures high efficiency, fast switching, and fast transient response. This control scheme is simple: when the output voltage is below the regulation threshold, the error comparator begins a switching cycle by turning on the high-side switch. This switch remains on until the minimum on-time expires and the output voltage is above the regulation threshold plus hysteresis or the inductor current is above the current-limit threshold. Once off, the high-side switch remains off until the minimum off-time expires and the output voltage falls again below the regulation threshold. During the off period, the low-side synchronous rectifier turns on and remains on until either the high-side switch turns on again or the inductor current approaches zero. The internal synchronous rectifier eliminates the need for an external Schottky diode.

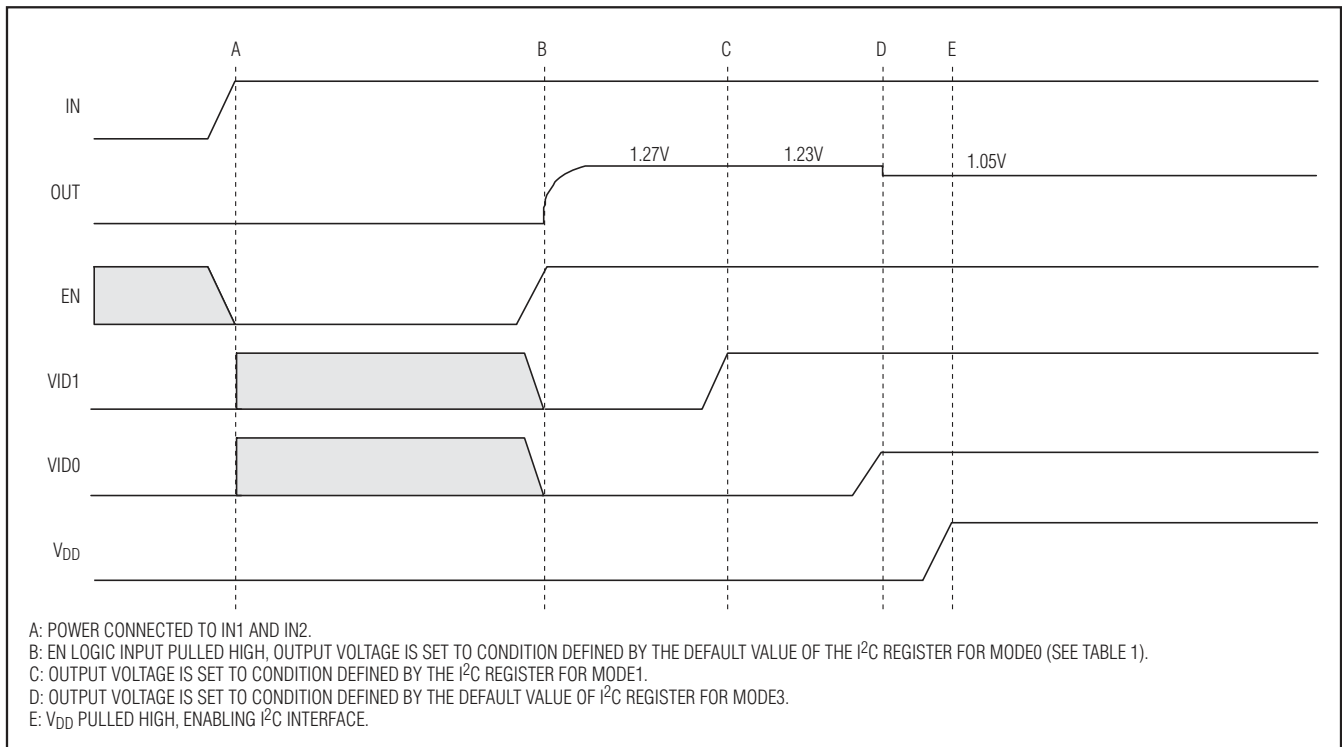

Figure 2. Power-Up Sequence

# 1.8A Step-Down Regulator with Remote Sense in 2mm x 2mm WLP

MAX8649/MAX8649A

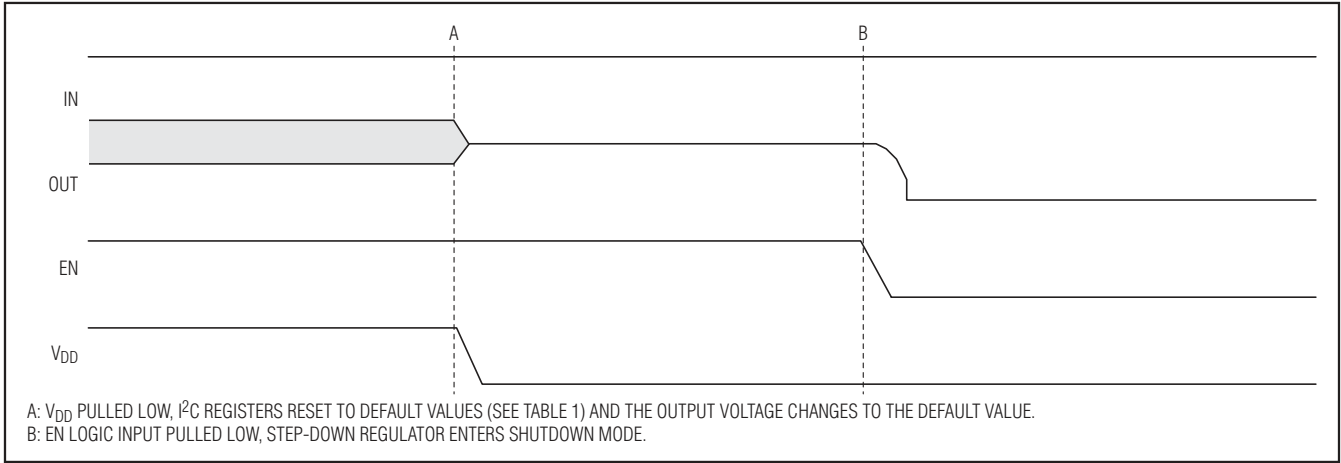

Figure 3a. Shutdown by Pulling  $V_{DD}$  Low Before EN

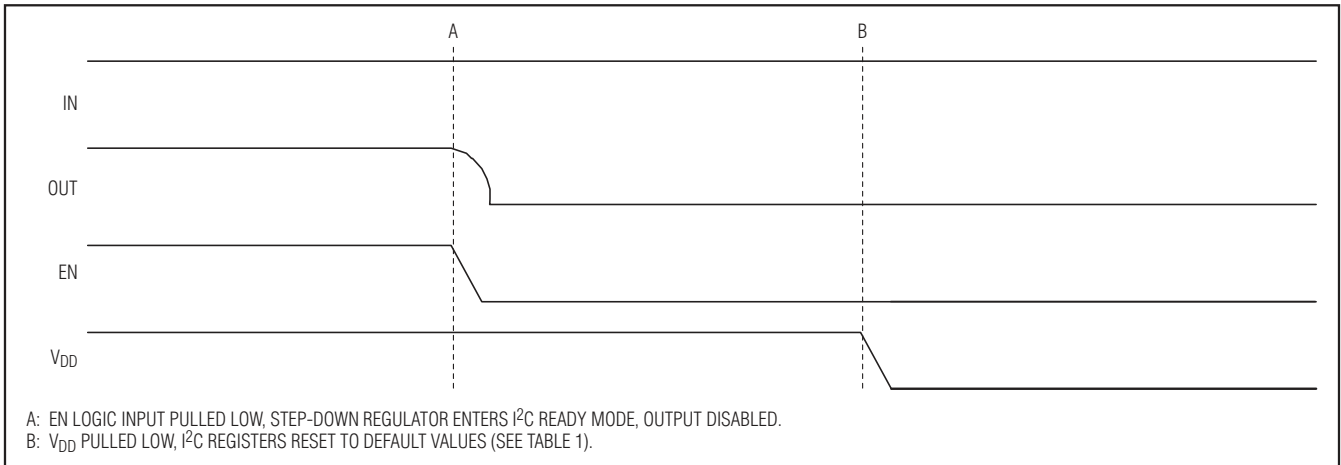

Figure 3b. Shutdown by Pulling EN Low Before  $V_{DD}$

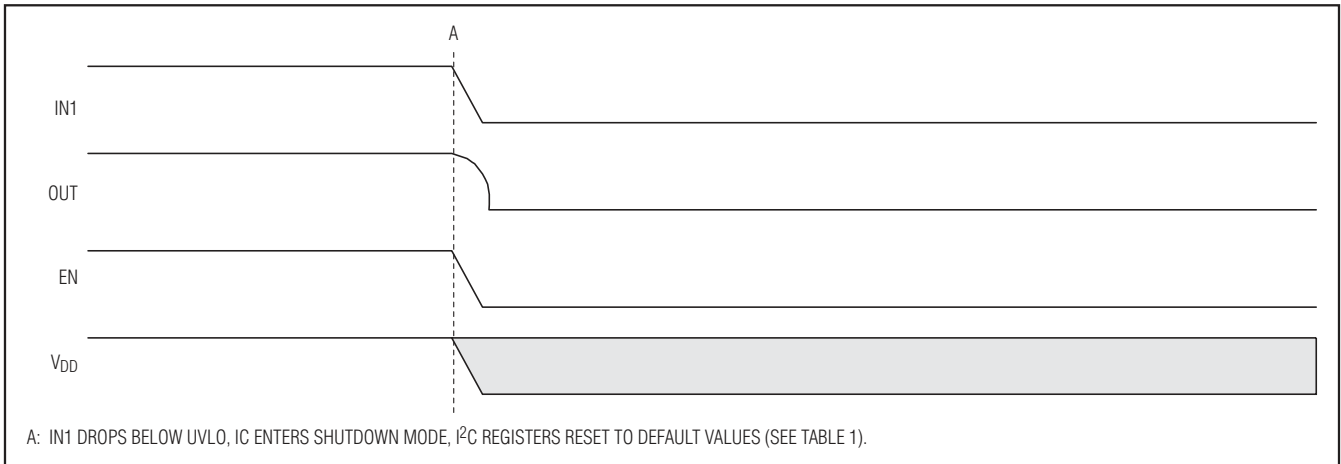

Figure 3c. Shutdown Due to IN1 Undervoltage Lockout

# 1.8A Step-Down Regulator with Remote Sense in 2mm x 2mm WLP

The transition between PWM and hysteretic operation is based on the number of consecutive zero-crossing cycles. When more than 16 consecutive zero-crossing cycles are detected, the DC-DC step-down converter enables the bias for hysteretic operation. Once correctly biased and the number of consecutive zero-crossing cycles exceeds 24, the DC-DC step-down converter begins hysteretic operation.

During hysteretic operation, there is a silent DC offset due to the use of valley regulation. See Figure 4.

When operating in power-save mode and the load current is increased so that the number of consecutive zero-crossing cycles is less than 16, the PWM mode is biased. Once fully biased and the number of zero-crossing cycles drops below 8, the DC-DC converter then begins PWM operation. Since there is a delay between the increase in load current and the

DC-DC converter starting PWM, the converter supports full current on the output during hysteretic operation. See Figure 5 for a detailed state diagram.

Power-save operation offers improved efficiency at light loads by changing to hysteretic mode, reducing the switching frequency depending on the load condition. With moderate to heavy loading, the regulator switches at a fixed switching frequency as it does in forced-PWM mode. In power-save mode, the transition from hysteretic mode to fixed-frequency switching occurs at the load current specified in the following equation:

$$I_{OUT} = \frac{V_{IN} - V_{OUT}}{2 \times L} \times \frac{V_{OUT}}{V_{IN} \times f_{OSC}}$$

In forced-PWM mode, the regulator operates with a constant (3.25MHz or synchronized to external clock source) switching frequency regardless of output load.

Forced-PWM mode is ideal for low-noise systems because switching harmonics occur at multiples of the constant switching frequency and are easily filtered. However, light-load power consumption in forced-PWM mode is higher than that of power-save mode.

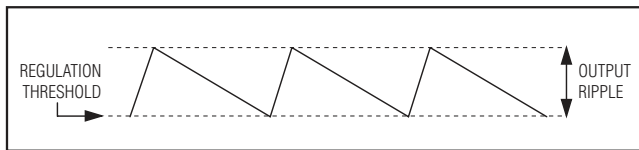

Figure 4. Output Regulation in Hysteretic Operation

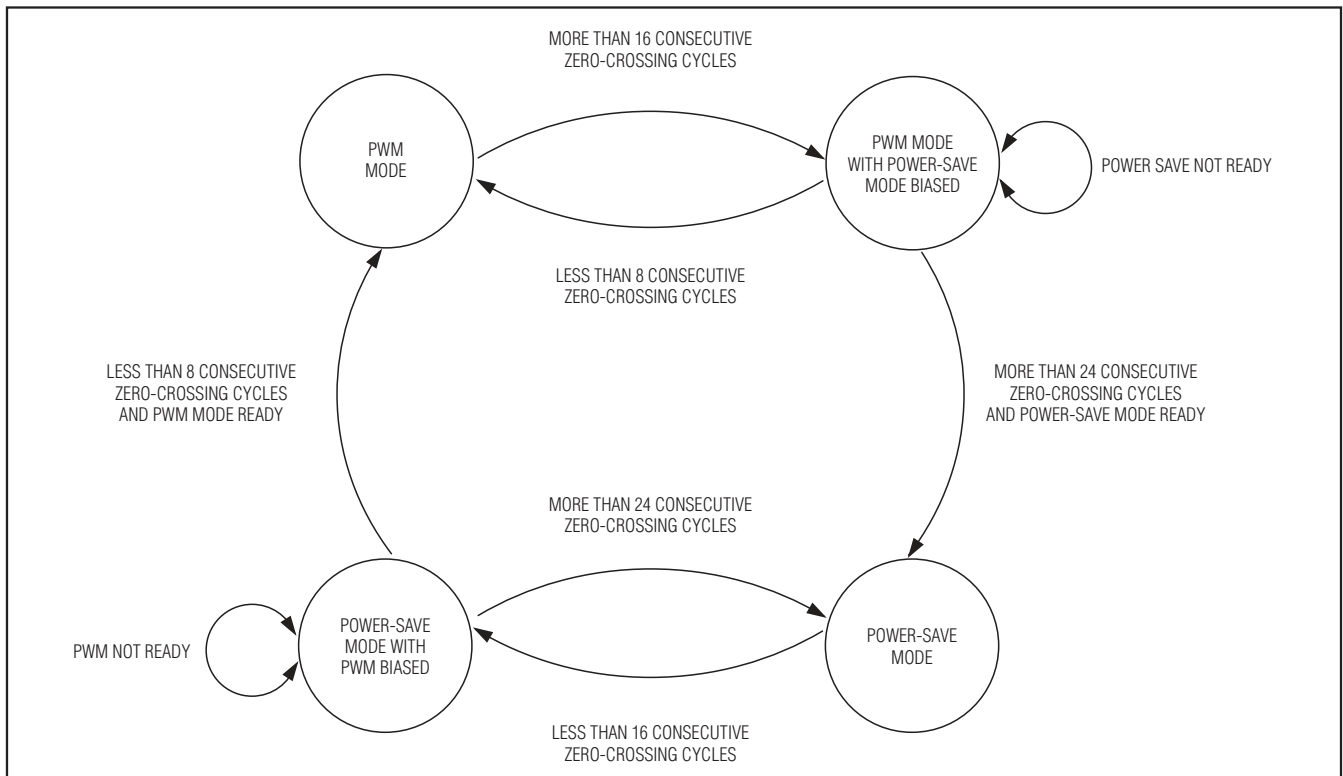

Figure 5. Mode Change for DC-DC Step-Down Converter

# 1.8A Step-Down Regulator with Remote Sense in 2mm x 2mm WLP

## Soft-Start

The ICs include internal soft-start circuitry that eliminates inrush current at startup, reducing transients on the input source (see the *Typical Operating Characteristics*). Soft-start is particularly useful for high-impedance input sources, such as Li+ and alkaline cells. When enabling the ICs into a prebiased output, the ICs perform a complete soft-start cycle.

## Synchronous Rectification

An internal n-channel synchronous rectifier eliminates the need for an external Schottky diode and improves efficiency. The synchronous rectifier turns on during the second half of each switching cycle (off-time). During this time, the voltage across the inductor is reversed, and the inductor current ramps down. In PWM mode, the synchronous rectifier turns off at the end of the switching cycle. In power-save mode, the synchronous rectifier turns off when the inductor current falls below 50mA (typ) or at the end of the switching cycle, whichever occurs first.

## Ramp-Rate Control

The output voltage has an actively controlled variable ramp rate, set with the I<sup>2</sup>C interface (see Figures 6, 7, and 8). The value set in the RAMP register controls the output voltage ramp rate. The RAMP\_DOWN bit controls the active ramp-down behavior in power-save

mode. When the regulator is set for power-save mode and the RAMP\_DOWN bit is cleared, the ramp-down is not actively controlled, and the regulator output voltage ramps down at the rate determined by the output capacitance and the external load. Small loads result in an output-voltage decay that is slower than that specified by RAMP; large loads result in an output-voltage decay that is no faster than that specified by RAMP. When the RAMP\_DOWN bit is set in power-save mode, the zero-cross comparator is disabled during the ramp-down condition. Active ramp-down functionality is inherent in forced-PWM operation.

Calculate the maximum and minimum values for the ramp rate as follows:

$$t_{RAMP\_MIN} = \frac{V_{OUT\_LSB}}{t_{CLK\_MAX}} \times \frac{1}{2^{RAMP\_CODE}}$$

$$t_{RAMP\_MAX} = \frac{V_{OUT\_LSB}}{t_{CLK\_MIN}} \times \frac{1}{2^{RAMP\_CODE}}$$

where:

$$V_{OUT\_LSB} = 10mV$$

$$t_{CLK\_MAX} = \frac{1}{f_{SW\_MIN}}$$

$$t_{CLK\_MIN} = \frac{1}{f_{SW\_MAX}}$$

$f_{SW} = 3.25MHz \pm 10%$  for PWM operation

$f_{SW} = 3.25MHz \pm 25%$  for hysteretic operation

$$f_{SW} = \frac{f_{SYNC}}{n}$$

$f_{SYNC}$  = frequency of external clock

$n = 4$  for 13MHz,  $6$  for 19.2MHz, and  $8$  for 26MHz

RAMP\_CODE = value of the RAMP[2:0] register (see Table 9)

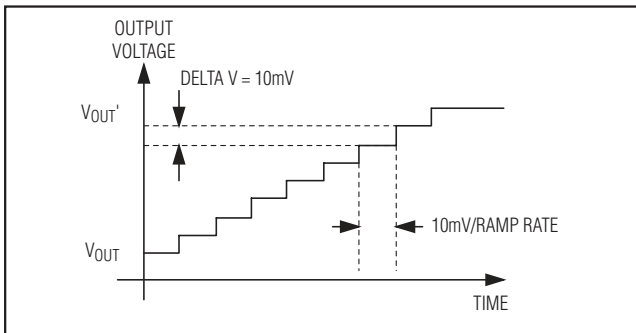

Figure 6. Ramp-Up Function

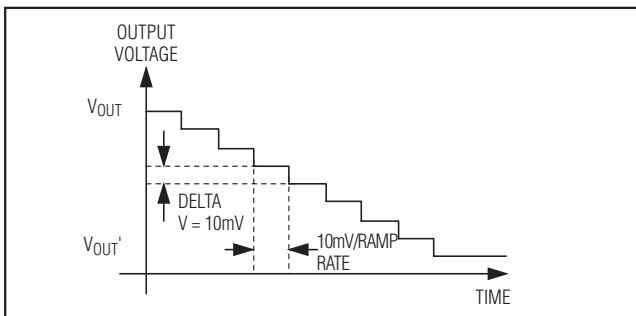

Figure 7. Ramp-Down Function

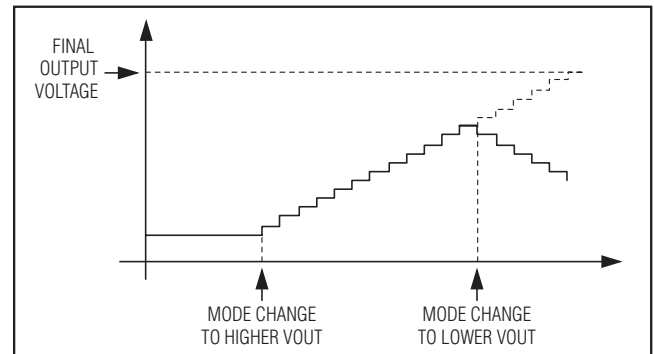

Figure 8. Mode Change Before Final Value is Reached

## 1.8A Step-Down Regulator with Remote Sense in 2mm x 2mm WLP

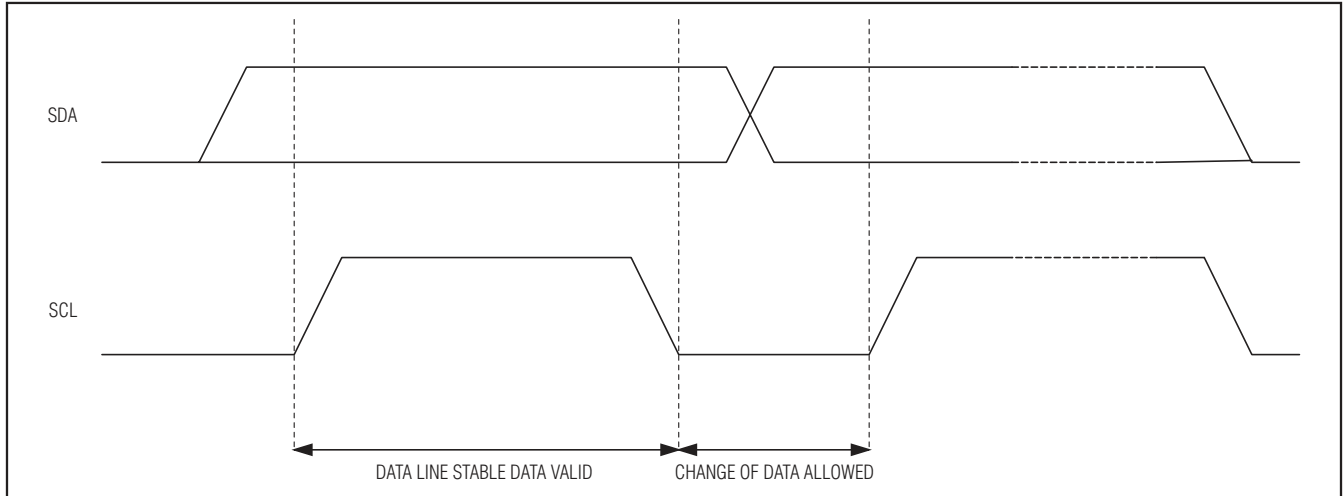

Figure 9. I<sup>2</sup>C Bit Transfer

### Thermal-Overload Protection

Thermal-overload protection limits total power dissipation in the ICs. When internal thermal sensors detect a die temperature in excess of +160°C (typ), the DC-DC step-down regulator is shut down, allowing the IC to cool. The DC-DC step-down regulator is turned on again after the junction cools by 20°C (typ), resulting in a pulsed output during continuous thermal-overload conditions.

During thermal overload, the I<sup>2</sup>C interface remains active and all register values are maintained.

### I<sup>2</sup>C Interface

An I<sup>2</sup>C-compatible, 2-wire serial interface controls the step-down converter output voltage, ramp rate, operating mode, and synchronization. The serial bus consists of a bidirectional serial-data line (SDA) and a serial-clock input (SCL). The master initiates data transfer on the bus and generates SCL to permit data transfer.

I<sup>2</sup>C is an open-drain bus. SDA and SCL require pullup resistors (500Ω or greater). Optional (24Ω) in series with SDA and SCL protect the device inputs from high-voltage spikes on the bus lines. Series resistors also minimize crosstalk and undershoot on bus signals.

### Bit Transfer

One data bit is transferred during each SCL clock cycle. The data on SDA must remain stable during the high period of the SCL clock pulse (see Figure 9). Changes in SDA while SCL is high are control signals (see the *START and STOP Conditions* section for more information).

Each transmit sequence is framed by a START (S) condition and a STOP (P) condition. Each data packet is 9 bits long; 8 bits of data followed by the acknowledge bit. The ICs support data transfer rates with SCL frequencies up to 400kHz.

### START and STOP Conditions

When the serial interface is inactive, SDA and SCL idle high. A master device initiates communication by issuing a START (S) condition. A START condition is a high-to-low transition on SDA with SCL high. A STOP (P) condition is a low-to-high transition on SDA, while SCL is high (Figure 10).

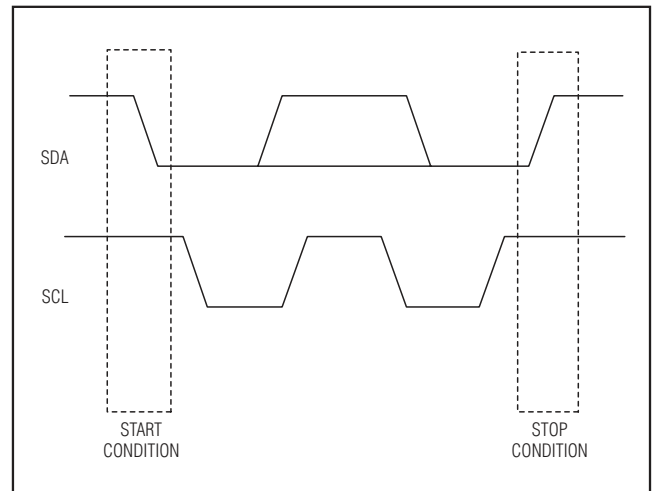

Figure 10. I<sup>2</sup>C START and STOP Conditions



# 1.8A Step-Down Regulator with Remote Sense in 2mm x 2mm WLP

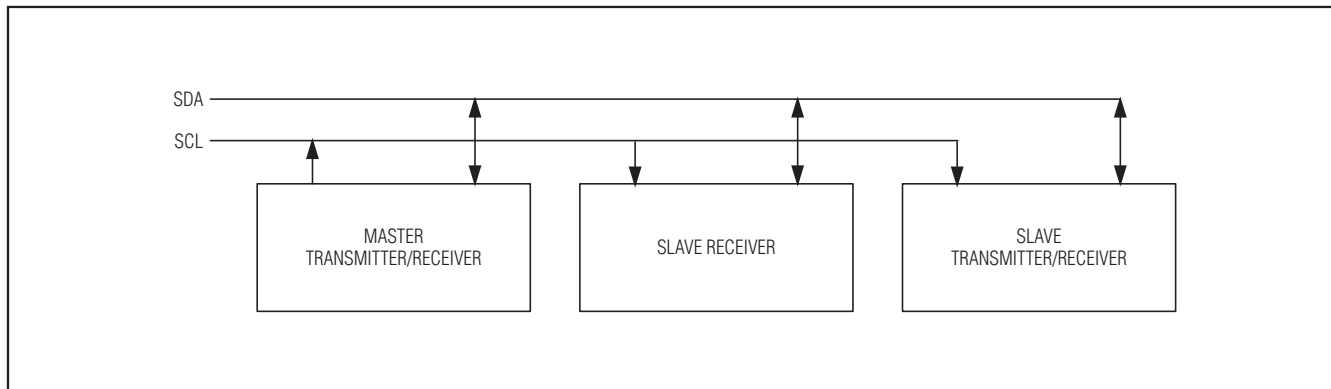

Figure 11. I<sup>2</sup>C Master/Slave Configuration

A START condition from the master signals the beginning of a transmission to the ICs. The master terminates transmission by issuing a not acknowledge followed by a STOP condition (see the *Acknowledge* section for more information). The STOP condition frees the bus. To issue a series of commands to the slave, the master can issue REPEATED START (Sr) commands instead of a STOP command to maintain control of the bus. In general, a REPEATED START command is functionally equivalent to a regular START command. When a STOP condition or incorrect address is detected, the MAX8649/MAX8649A internally disconnects SCL from the serial interface until the next START condition, minimizing digital noise and feedthrough.

### System Configuration

A device on the I<sup>2</sup>C bus that generates a message is called a transmitter and a device that receives the message is a receiver. The device that controls the message is the master and the devices that are controlled by the master are called slaves. See Figure 11.

### Acknowledge

The number of data bytes between the START and STOP conditions for the transmitter and receiver are unlimited. Each 8-bit byte is followed by an acknowledge bit. The acknowledge bit is a high-level signal put on SDA by the transmitter during which time the master generates an extra acknowledge-related clock pulse. A slave receiver that is addressed must generate an acknowledge after each byte it receives. Also, a master receiver must generate an acknowledge after each byte it receives that has been clocked out of the slave transmitter. See Figure 12.

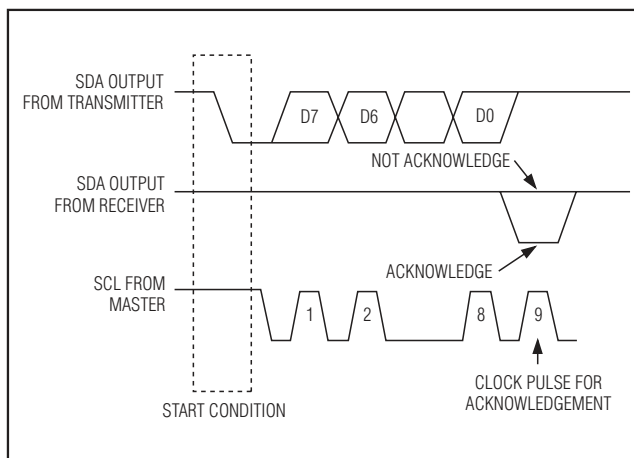

Figure 12. I<sup>2</sup>C Acknowledge

The device that acknowledges must pull down the DATA line during the acknowledge clock pulse, so that the DATA line is stable low during the high period of the acknowledge clock pulse (setup and hold times must also be met). A master receiver must signal an end of data to the transmitter by not generating an acknowledge on the last byte that has been clocked out of the slave. In this case, the transmitter must leave SDA high to enable the master to generate a STOP (P) condition.

### Register Reset

The I<sup>2</sup>C registers reset back to their default values when the voltage at either IN1 or V<sub>DD</sub> drops below the corresponding UVLO threshold (see the *Electrical Characteristics* table).

## 1.8A Step-Down Regulator with Remote Sense in 2mm x 2mm WLP

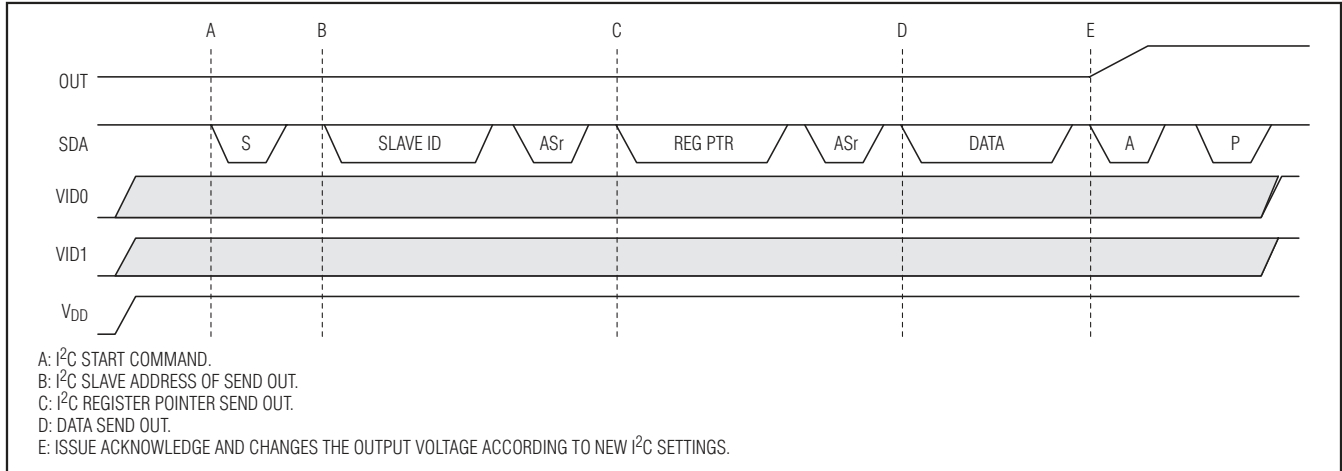

Figure 13. Update Output Operation

### Update of Output Operation Mode

If updating the output voltage or Operation Mode register for the mode that the ICs are currently operating in, the output voltage/operation mode is updated at the same time the ICs send the acknowledge for the I<sup>2</sup>C data byte (see Figure 13).

### Slave Address

A bus master initiates communication with a slave device (MAX8649/MAX8649A) by issuing a START (S) condition followed by the slave address (the slave address byte consists of 7 address bits (1100 000x for MAX8649; 1100 010x for MAX8649A) and a read/write bit (R/W)). After receiving the proper address, the ICs issues an acknowledge by pulling SDA low during the ninth clock cycle.

The ICs provide different I<sup>2</sup>C slave addresses, allowing up to two devices to be used in a system without causing bus collisions. Contact the factory for availability.

### Write Operations

The ICs recognize the write byte protocol as defined in the SMBus specification and shown in Figures 14a and 14b. The write byte protocol allows the I<sup>2</sup>C master device to send 1 byte of data to the slave device. The write byte protocol requires a register pointer address for the subsequent write. The ICs acknowledge any register pointer even though only a subset of those registers actually exists in the device. The write byte protocol is as follows:

- 1) The master sends a start command.
- 2) The master sends the 7-bit slave address followed by a write bit.
- 3) The addressed slave asserts an acknowledge by pulling SDA low.

- 4) The master sends an 8-bit register pointer.
- 5) The slave acknowledges the register pointer.
- 6) The master sends a data byte.
- 7) The slave acknowledges the data byte.
- 8) The slave updates with the new data.
- 9) The master sends a STOP (P) condition.

In addition to the write-byte protocol, the ICs can write to multiple registers as shown in Figure 14b. This protocol allows the I<sup>2</sup>C master device to address the slave only once and then send data to a sequential block of registers starting at the specified register pointer.

Use the following procedure to write to a sequential block of registers:

- 1) The master sends a start command.
- 2) The master sends the 7-bit slave address followed by a write bit.
- 3) The addressed slave asserts an acknowledge by pulling SDA low.
- 4) The master sends the 8-bit register pointer of the first register to write.
- 5) The slave acknowledges the register pointer.
- 6) The master sends a data byte.
- 7) The slave acknowledges the data byte.
- 8) The slave updates with the new data.
- 9) Steps 6 to 8 are repeated for as many registers in the block, with the register pointer automatically incremented each time.
- 10) The master sends a STOP condition.

# 1.8A Step-Down Regulator with Remote Sense in 2mm x 2mm WLP

MAX8649/MAX8649A

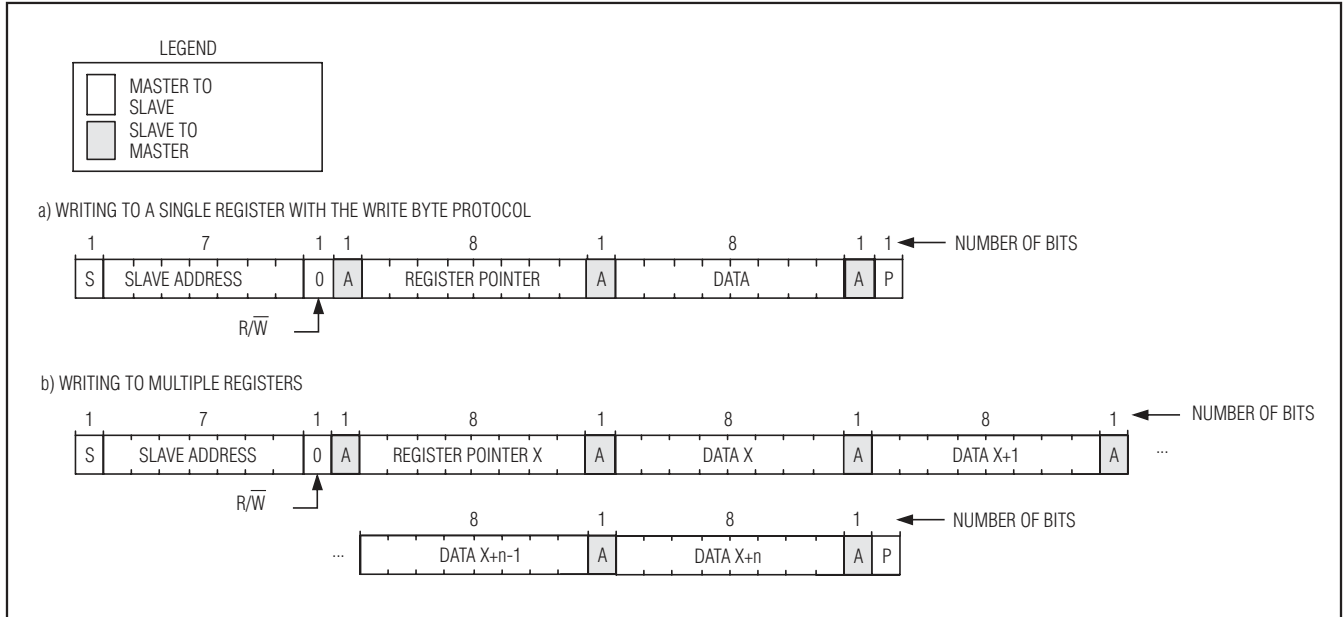

Figures 14a and 14b. Writing to the ICs

### Read Operations

The method for reading a single register (byte) is shown in Figure 15a. To read a single register:

- 1) The master sends a start command.
- 2) The master sends the 7-bit slave address followed by a write bit.
- 3) The addressed slave asserts an acknowledge by pulling SDA low.
- 4) The master sends an 8-bit register pointer.
- 5) The slave acknowledges the register pointer.
- 6) The master sends a repeated START (S) condition.
- 7) The master sends the 7-bit slave address followed by a read bit.
- 8) The slave asserts an acknowledge by pulling SDA low.
- 9) The slave sends the 8-bit data (contents of the register).
- 10) The master asserts a not acknowledge by keeping SDA high.
- 11) The master sends a STOP (P) condition.

In addition, the MAX8649/MAX8649A can read a block of multiple sequential registers as shown in Figure 15b. Use the following procedure to read a sequential block of registers:

- 1) The master sends a start command.
- 2) The master sends the 7-bit slave address followed by a write bit.
- 3) The addressed slave asserts an acknowledge by pulling SDA low.
- 4) The master sends an 8-bit register pointer of the first register in the block.
- 5) The slave acknowledges the register pointer.
- 6) The master sends a repeated START condition.
- 7) The master sends the 7-bit slave address followed by a read bit.
- 8) The slave asserts an acknowledge by pulling SDA low.
- 9) The slave sends the 8-bit data (contents of the register).
- 10) The master asserts an acknowledge by pulling SDA low when there is more data to read, or a not acknowledge by keeping SDA high when all data has been read.
- 11) Steps 9 and 10 are repeated for as many registers in the block, with the register pointer automatically incremented each time.
- 12) The master sends a STOP condition.

# 1.8A Step-Down Regulator with Remote Sense in 2mm x 2mm WLP

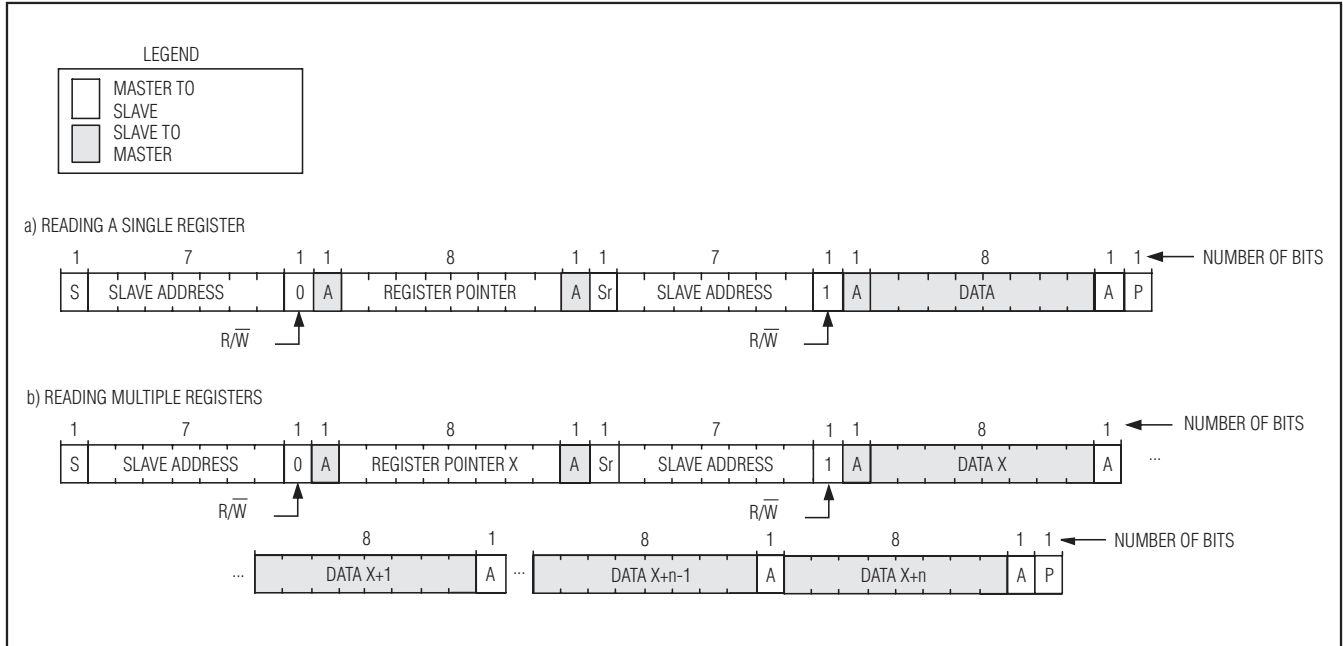

Figures 15a and 15b. Reading from the ICs

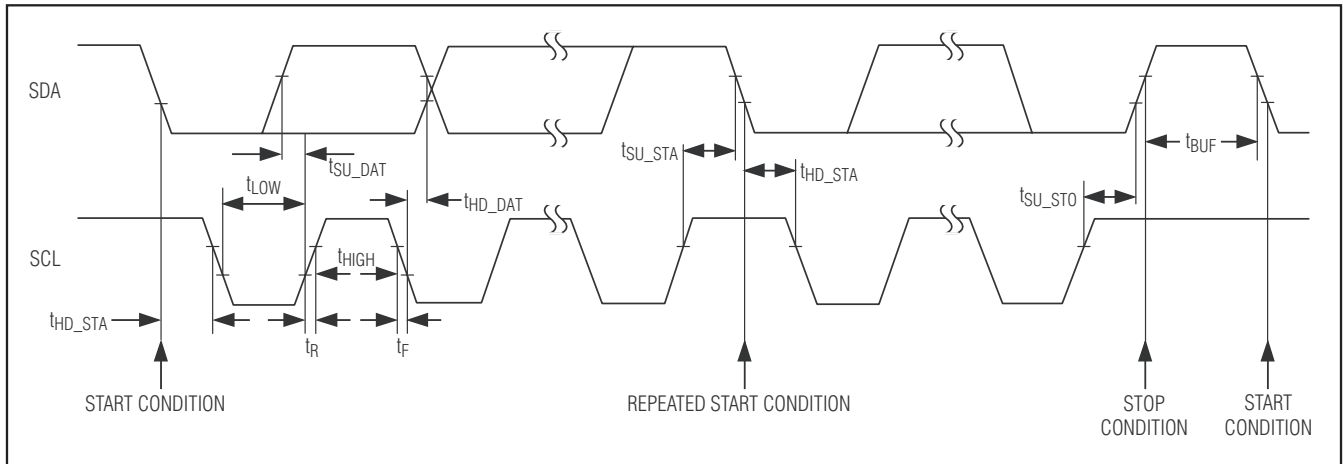

Figure 16. I<sup>2</sup>C Timing Diagram

# 1.8A Step-Down Regulator with Remote Sense in 2mm x 2mm WLP

MAX8649/MAX8649A

**Table 2. I<sup>2</sup>C Register Map**

POINTER	REGISTER	POR	BIT7	BIT6	BIT5	BIT4	BIT3	BIT2	BIT1	BIT0
0x00	MODE0	0xB4	OPER MODE	SYNC MODE	OUT MODE0[5:0]					
0x01	MODE1	0x1E	OPER MODE	SYNC MODE	OUT MODE1[5:0]					
0x02	MODE2	0xB0	OPER MODE	SYNC MODE	OUT MODE2[5:0]					
0x03	MODE3	0x9E	OPER MODE	SYNC MODE	OUT MODE3[5:0]					
0x04	CONTROL	0xE0	EN_PD	VID0_PD	VID1_PD	—	—	—	—	—
0x05	SYNC	0x00	SYNC[1:0]		—	—	—	—	—	—
0x06	RAMP	0x01	RAMP[2:0]			FORCE_HYS	FORCE_OSC	—	RAMP_DOWN	—
0x08	CHIP_ID1	0x20	DIE TYPE[7:4]				DIE TYPE[3:0]			
0x09	CHIP_ID2	0x0E	DASH[3:0]				MASK REV[3:0]			

**Table 3. I<sup>2</sup>C Register: MODE0**

This register contains output voltage and operation mode control for MODE0, VID0 = GND, VID1 = GND.

REGISTER NAME	MODE0
Address	0x00h
Reset Value	0xB4h
Type	Read/write
Special Features	Reset upon V <sub>DD</sub> or IN1 UVLO

BIT	NAME	DESCRIPTION	DEFAULT VALUE
B7 (MSB)	OPERATION_MODE0	<b>DC-DC Step-Down Converter Operation Mode for MODE0</b> 0 = DC-DC converter automatically changes between hysteretic mode for light load conditions and PWM mode for medium to heavy load conditions. 1 = DC-DC converter operates in forced-PWM mode.	1
B6	SYNC_MODE0	<b>Disable/Enable Synchronization to External Clock</b> 0 = DC-DC converter ignores the external SYNC input regardless of operation mode. 1 = DC-DC converter synchronizes to external SYNC input when available.	0
B5	OUT_MODE0 [5:0]	<b>Output Voltage Selection for MODE0</b> 000000 = 0.75V 000001 = 0.76V 110011 = 1.26V 110100 = 1.27V 110101 = 1.28V 111110 = 1.37V 111111 = 1.38V	110100
B4			
B3			
B2			
B1			
B0 (LSB)			

## 1.8A Step-Down Regulator with Remote Sense in 2mm x 2mm WLP

**Table 4. I<sup>2</sup>C Register: MODE1**

This register contains output voltage and operation mode control for MODE1, VID1 = GND, VID0 = V<sub>DD</sub>.

REGISTER NAME	MODE1
Address	0x01h
Reset Value	0x1Eh
Type	Read/write
Special Features	Reset upon V <sub>DD</sub> or IN1 UVLO

BIT	NAME	DESCRIPTION	DEFAULT VALUE
B7 (MSB)	OPERATION_MODE1	<b>DC-DC Step-Down Converter Operation Mode for MODE1</b> 0 = DC-DC converter automatically changes between hysteretic mode for light load conditions and PWM mode for medium to heavy load conditions. 1 = DC-DC converter operates in forced-PWM mode.	0
B6	SYNC_MODE1	<b>Disable/Enable Synchronization to External Clock</b> 0 = DC-DC converter ignores the external SYNC input regardless of operation mode. 1 = DC-DC converter synchronizes to external SYNC input when available.	0
B5	OUT_MODE1[5:0]	<b>Output Voltage Selection for MODE1</b> 000000 = 0.75V 000001 = 0.76V 011101 = 1.04V 011110 = 1.05V 011111 = 1.06V 111110 = 1.37V 111111 = 1.38V	011110
B4			
B3			
B2			
B1			
B0 (LSB)			

# 1.8A Step-Down Regulator with Remote Sense in 2mm x 2mm WLP

MAX8649/MAX8649A

**Table 5. I<sup>2</sup>C Register: MODE2**

This register contains output voltage and operation mode control for MODE2, VID1 = V<sub>DD</sub>, VID0 = GND.

REGISTER NAME	MODE2
Address	0x02h
Reset Value	0xB0h
Type	Read/write
Special Features	Reset upon V <sub>DD</sub> or IN1 UVLO

BIT	NAME	DESCRIPTION	DEFAULT VALUE
B7 (MSB)	OPERATION_MODE2	<b>DC-DC Step-Down Converter Operation Mode for MODE2</b> 0 = DC-DC converter automatically changes between hysteretic mode for light load conditions and PWM mode for medium to heavy load conditions. 1 = DC-DC converter operates in forced-PWM mode.	1
B6	SYNC_MODE2	<b>Disable/Enable Synchronization to External Clock</b> 0 = DC-DC converter ignores the external SYNC input regardless of operation mode. 1 = DC-DC converter synchronizes to external SYNC input when available.	0
B5	OUT_MODE2[5:0]	<b>Output Voltage Selection for MODE2</b> 000000 = 0.75V 000001 = 0.76V 101110 = 1.21V 101111 = 1.22V 110000 = 1.23V 111110 = 1.37V 111111 = 1.38V	110000
B4			
B3			
B2			
B1			
B0 (LSB)			

## 1.8A Step-Down Regulator with Remote Sense in 2mm x 2mm WLP

**Table 6. I<sup>2</sup>C Register: MODE3**

This register contains output voltage and operation mode control for MODE3, VID1 = V<sub>DD</sub>, VID0 = V<sub>DD</sub>.

REGISTER NAME	MODE3
Address	0x03h
Reset Value	0x9Eh
Type	Read/write
Special Features	Reset upon V <sub>DD</sub> or IN1 UVLO

BIT	NAME	DESCRIPTION	DEFAULT VALUE
B7 (MSB)	OPERATION_MODE3	<b>DC-DC Step-Down Converter Operation Mode for MODE3</b> 0 = DC-DC converter automatically changes between hysteretic mode for light load conditions and PWM mode for medium to heavy load conditions. 1 = DC-DC converter operates in forced-PWM mode.	1
B6	SYNC_MODE3	<b>Disable/Enable Synchronization to External Clock</b> 0 = DC-DC converter ignores the external SYNC input regardless of operation mode. 1 = DC-DC converter synchronizes to external SYNC input when available.	0
B5	OUT_MODE3[5:0]	<b>Output Voltage Selection for MODE3</b> 000000 = 0.75V 000001 = 0.76V 011101 = 1.04V 011110 = 1.05V 011111 = 1.06V 111110 = 1.37V 111111 = 1.38V	011110
B4			
B3			
B2			
B1			
B0 (LSB)			



## 1.8A Step-Down Regulator with Remote Sense in 2mm x 2mm WLP

**Table 7. I<sup>2</sup>C Register: CONTROL**

This register enables or disables pulldown resistors.

REGISTER NAME	CONTROL
Address	0x04h
Reset Value	0xE0h
Type	Read/write
Special Features	Reset upon V <sub>DD</sub> , IN1 UVLO or EN pulled low

BIT	NAME	DESCRIPTION	DEFAULT VALUE
B7 (MSB)	EN_PD	0 = Pulldown on EN input is disabled. 1 = Pulldown on EN input is enabled.	1
B6	VID0_PD	0 = Pulldown on VID0 input is disabled. 1 = Pulldown on VID0 input is enabled.	1
B5	VID1_PD	0 = Pulldown on VID1 input is disabled. 1 = Pulldown on VID1 input is enabled.	1
B4	—	Reserved for future use.	0
B3	—	Reserved for future use.	0
B2	—	Reserved for future use.	0
B1	—	Reserved for future use.	0
B0 (LSB)	—	Reserved for future use.	0

**MAX8649/MAX8649A**

## 1.8A Step-Down Regulator with Remote Sense in 2mm x 2mm WLP

**Table 8. I<sup>2</sup>C Register: SYNC**

This register specifies the clock frequency of external clock source.

REGISTER NAME	SYNC
Address	0x05h
Reset Value	0x00h
Type	Read
Special Features	Reset upon V <sub>DD</sub> or IN1 UVLO

BIT	NAME	DESCRIPTION	DEFAULT VALUE
B7 (MSB)	SYNC[1:0]	<b>Sets Clock Frequency of External Clock Present on SYNC Input</b> 00 = 26MHz 01 = 13MHz 10 = 19.2MHz 11 = 19.2MHz	00
B6			
B5	—	Reserved for future use.	0
B4	—	Reserved for future use.	0
B3	—	Reserved for future use.	0
B2	—	Reserved for future use.	0
B1	—	Reserved for future use.	0
B0 (LSB)	—	Reserved for future use.	0

# 1.8A Step-Down Regulator with Remote Sense in 2mm x 2mm WLP

MAX8649/MAX8649A

**Table 9. I<sup>2</sup>C Register: RAMP**

This register controls of ramp-up/down function.

REGISTER NAME	RAMP
Address	0x06h
Reset Value	0x01h
Type	Read
Special Features	Reset upon V <sub>DD</sub> or IN1 UVLO

BIT	NAME	DESCRIPTION	DEFAULT VALUE
B7 (MSB)	RAMP[2:0]	<b>Control the RAMP Timing</b> 000 = 32mV/μs 001 = 16mV/μs 010 = 8mV/μs 011 = 4mV/μs 100 = 2mV/μs 101 = 1mV/μs 110 = 0.5mV/μs 111 = 0.25mV/μs	000
B6			
B5			
B4	FORCE_HYS	<b>Only Valid When Converter is Operating in OPERATION_MODE 0</b> 0 = Automatically change between power-save mode and PWM mode, depending on load current. 1 = Converter always operates in power-save mode regardless of load current as long as OPERATION_MODE = 0. If OPERATION_MODE = 1, this setting is ignored.	0
B3	FORCE_OSC	<b>Force Oscillator While Running in Hysteretic Mode</b> 0 = Internal oscillator is disabled in power save when operating in hysteretic mode. 1 = Internal oscillator is enabled in power save even when operating in hysteretic mode.	0
B2	—	Reserved for future use.	0
B1	RAMP_DOWN	<b>Active Ramp-Down Control for Power-Save Mode</b> 0 = Active ramp disabled for power-save mode. 1 = During ramp-down, the error crossing detector is disabled allowing negative current to flow through the nMOS device.	0
B0 (LSB)	—	Reserve for future use.	1

## 1.8A Step-Down Regulator with Remote Sense in 2mm x 2mm WLP

**Table 10. I<sup>2</sup>C Register: CHIP\_ID1**

This register contains the die type number (20).

REGISTER NAME	CHIP_ID1
Address	0x08h
Reset Value	0x20h
Type	Read
Special Features	—

BIT	NAME	DESCRIPTION	DEFAULT VALUE
B7 (MSB)	DIE_TYPE[7:4]	BCD character (2)	0010
B6			
B5			
B4			
B3	DIE_TYPE[3:0]	BCD character (0)	0000
B2			
B1			
B0 (LSB)			

**Table 11. I<sup>2</sup>C Register: CHIP\_ID2**

This register contains the die type dash number and mask revision level.

REGISTER NAME	CHIP_ID2
Address	0x09h
Reset Value	0x0Eh
Type	Read
Special Features	—

BIT	NAME	DESCRIPTION	DEFAULT VALUE
B7 (MSB)	DASH	BCD character 0	0000
B6			
B5			
B4			
B3	MASK_REV	BCD character E	1110
B2			
B1			
B0 (LSB)			

# 1.8A Step-Down Regulator with Remote Sense in 2mm x 2mm WLP

MAX8649/MAX8649A

## Applications Information

### Inductor Selection

Calculate the inductor value ( $L_{IDEAL}$ ) using the following formula:

$$L_{IDEAL} = \frac{4 \times V_{IN} \times D \times (1-D)}{I_{OUT(MAX)} \times f_{OSC}}$$

This sets the peak-to-peak inductor current ripple to 1/4 the maximum output current. The oscillator frequency,  $f_{OSC}$ , is 3.25MHz, and the duty cycle,  $D$ , is:

$$D = \frac{V_{OUT}}{V_{IN}}$$

Given  $L_{IDEAL}$ , the peak-to-peak inductor ripple current is  $0.25 \times I_{OUT(MAX)}$ . The peak inductor current is  $1.125 \times I_{OUT(MAX)}$ . Make sure that the saturation current of the inductor exceeds the peak inductor current, and the rated maximum DC inductor current exceeds the maximum output current  $I_{OUT(MAX)}$ . Inductance values smaller than  $L_{IDEAL}$  can be used to reduce inductor size; however, if much smaller values are used, peak inductor current rises and a larger output capacitance may be required to suppress output ripple. Larger inductance values than  $L_{IDEAL}$  can be used to obtain higher output current, but typically require a physically larger inductor size. See Table 12 for recommended inductors.

Table 12. Recommended Inductors

MANUFACTURER	SERIES	INDUCTANCE ( $\mu$ H)	DC RESISTANCE ( $\Omega$ typ)	CURRENT RATING (mA)	DIMENSIONS L x W x H (mm)
Hitachi Metals	KSLI-2520AG Multilayer	1.0	0.075	1800	2.5 x 2.0 x 1.0
		1.5	0.075	1800	
		2.2	0.115	1400	
	KLSI-2016AG	0.75	0.09	1500	2.0 x 1.6 x 1.0
		1.0	0.09	1500	
		1.5	0.13	1100	
FDK	MIPSA2520D Multilayer	0.5	0.11	2000	2.5 x 2.0 x 0.5
		1.3	0.10	2000	
		1.6	0.09	2000	
		2.0	0.06	2000	
Taiyo Yuden	CKP3216 Multilayer	1.0	0.11	1100	3.2 x 1.6 x 0.9
		1.5	0.13	1000	
		2.2	0.14	900	
	NR3015	1.0	0.03	2100	3.0 x 3.0 x 1.5
		1.5	0.04	1800	
TDK	VLS3015T	1.0	0.048	2000	3.0 x 3.0 x 1.5
		2.2	0.070	1400	
TOKO	DE2812C	0.56	0.032	2300	3.2 x 3.0 x 1.2
		1.2	0.044	1800	
		1.5	0.050	1500	
		2.0	0.067	1400	
Coilcraft	LPS3008	0.56	0.072	1800	3.0 x 3.0 x 0.8
		0.80	0.092	1600	
		1.0	0.125	1400	
		1.5	0.134	1150	
		2.2			
	LPS3010	0.68	0.070	2300	3.0 x 3.0 x 1.0
		1.0	0.080	1800	
		1.5	0.085	1600	
		1.8	0.120	1300	
		2.2	0.150	1200	

## 1.8A Step-Down Regulator with Remote Sense in 2mm x 2mm WLP

### Input Capacitor Selection

The input capacitor in a step-down DC-DC regulator reduces current peaks drawn from the battery or other input power source and reduces switching noise in the controller. A 10 $\mu$ F ceramic capacitor in parallel with a 0.1 $\mu$ F ceramic capacitor is recommended for most applications. The impedance of the input capacitor at the switching frequency should be less than that of the input source so that high-frequency switching currents do not pass through the input source. The input capacitor must meet the input ripple-current requirement imposed by the step-down regulator. Ceramic capacitors are preferred due to their resilience to power-up surge currents. Choose the input capacitor so that the temperature rises due to input ripple current do not exceed approximately +10°C. For a step-down DC-DC regulator, the maximum input ripple current is 1/2 of the output. This maximum input ripple current occurs when the step-down regulator operates at 50% duty factor ( $V_{IN} = 2 \times V_{OUT}$ ). Refer to the MAX8649 Evaluation Kit data sheet for specific input capacitor recommendations.

### Output Capacitor Selection

The step-down DC-DC regulator output capacitor keeps output ripple small and ensures control-loop stability. A 10 $\mu$ F ceramic capacitor in parallel with a 0.1 $\mu$ F ceramic capacitor is recommended for most applications. The output capacitor must also have low impedance at the switching frequency. Ceramic, polymer, and tantalum capacitors are suitable, with ceramic exhibiting the lowest ESR and lowest high-frequency impedance.

Output ripple due to capacitance (neglecting ESR) is approximately:

$$V_{\text{RIPPLE}} = \frac{I_{L(\text{PEAK})}}{2\pi \times f_{\text{OSC}} \times C_{\text{OUT}}}$$

Additional ripple due to capacitor ESR is:

$$V_{\text{RIPPLE}}(\text{ESR}) = I_{L(\text{PEAK})} \times \text{ESR}$$

Refer to the MAX8649 Evaluation Kit data sheet for specific output capacitor recommendations.

### Power Dissipation

The ICs have a thermal-shutdown feature that protects the IC from damage when the die temperature exceeds +160°C. See the *Thermal-Overload Protection* section for more information. To prevent thermal overload and allow the maximum load current on each regulator, it is important to ensure that the heat generated by the ICs can be dissipated into the PCB.

When properly mounted on a multilayer PCB, the junction-to-ambient thermal resistance ( $\theta_{JA}$ ) is typically 76°C/W.

### PCB Layout

Due to fast switching waveforms and high current paths, careful PCB layout is required to achieve optimal performance. Due to fast switching waveforms and high current paths, careful PCB layout is required to achieve optimal performance. Minimize trace lengths between the ICs and the inductor, the input capacitor, and the output capacitor; keep these traces short, direct, and wide. The ground connections of  $C_{IN}$  and  $C_{OUT}$  should be as close together as possible and connected to PGND. Connect AGND and PGND directly to the ground plane. The MAX8649 Evaluation Kit illustrates an example PCB layout and routing scheme. Special care should be taken when routing the remote sense signals. Use a wide SNS+ trace to minimize parasitic inductance in the SNS+ feedback trace. Do not use vias on the SNS+ trace because they introduce additional inductance. Connect SNS- to the local AGND plane for the ICs.

### Chip Information

PROCESS: BiCMOS

### Package Information

For the latest package outline information and land patterns (footprints), go to [www.maxim-ic.com/packages](http://www.maxim-ic.com/packages). Note that a "+", "#", or "-" in the package code indicates RoHS status only. Package drawings may show a different suffix character, but the drawing pertains to the package regardless of RoHS status.

PACKAGE TYPE	PACKAGE CODE	OUTLINE NO.	LAND PATTERN NO.
16 WLP 0.5mm Pitch	W162B2+1	<a href="#">21-0200</a>	Refer to <a href="#">Application Note 1891</a>

# 1.8A Step-Down Regulator with Remote Sense in 2mm x 2mm WLP

## Revision History

REVISION NUMBER	REVISION DATE	DESCRIPTION	PAGES CHANGED
0	9/09	Initial release	—
1	2/10	Corrected errors in Table 1 and Figure 2	11, 12
2	9/10	Added MAX8649A to data sheet	1-31
3	2/11	Updated the <i>PCB Layout</i> section	30
4	6/11	Updated remote sense, <i>Typical Operating Circuit</i> , SNS+ and SNS- input impedance entry, C1 bump description, Figure 1, and <i>PCB Layout</i> section	1, 5, 10, 11, 30

MAX8649/MAX8649A

Maxim cannot assume responsibility for use of any circuitry other than circuitry entirely embodied in a Maxim product. No circuit patent licenses are implied. Maxim reserves the right to change the circuitry and specifications without notice at any time.

Maxim Integrated Products, 120 San Gabriel Drive, Sunnyvale, CA 94086 408-737-7600 \_\_\_\_\_ 31