

1241965-2 ✓ ACTIVE

RAST | RAST 5 IDC Connectors

TE Internal #: 1241965-2

Housing, Plug, Wire-to-Board, 2 Position, .197 in [5 mm] Centerline,
Crimp, 1 Row, Natural, Mating Retention, Wire & Cable, RAST 5
IDC Connectors

[View on TE.com >](#)



Connectors > PCB Connectors > Wire-to-Board Connectors > Wire-to-Board Connector Assemblies & Housings

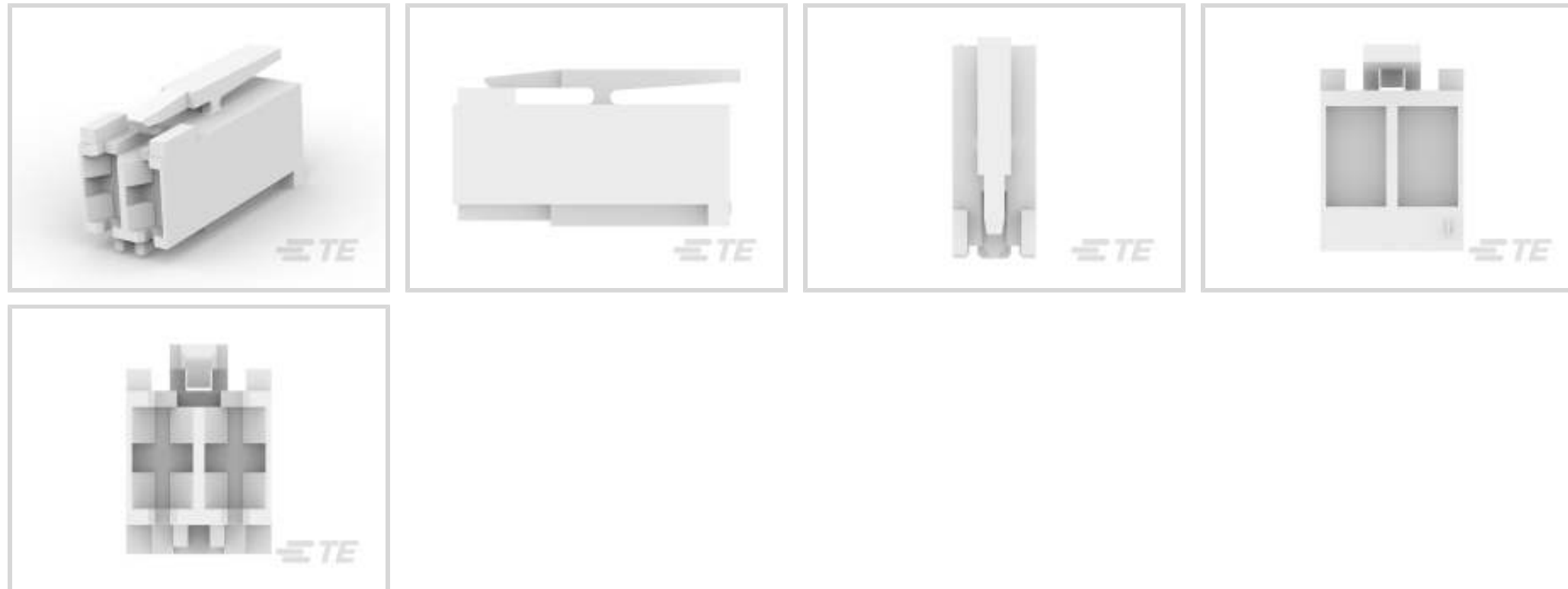

Connector Product Type: **Housing**

Connector & Housing Type: **Plug**

Connector System: **Wire-to-Board**

Number of Positions: **2**

Centerline (Pitch): **5 mm [.197 in]**

Features

Product Type Features

Connector Product Type	Housing
Connector & Housing Type	Plug
Connector System	Wire-to-Board
Sealable	No
Connector & Contact Terminates To	Wire & Cable

Configuration Features

Keying & Polarized Rib Location	1b,2a
Number of Positions	2
Number of Rows	1

Body Features

Primary Product Color	Natural
-----------------------	---------

Termination Features

Termination Method to Wire & Cable	Crimp
------------------------------------	-------



Mechanical Attachment

Locking Latch Between Cavity Number	1&2
Strain Relief	Without
Panel Mount Feature	Without
PCB Mount Retention	Without
Mating Retention Type	Latch
Mating Retention	With
Connector Mounting Type	Cable Mount (Free-Hanging)

Housing Features

Housing Entry Configuration	Both Ends Closed
Housing Material	Nylon
Centerline (Pitch)	5 mm [.197 in]

Dimensions

Connector Length	25.5 mm [1 in]
Connector Height	13.9 mm [.547 in]

Usage Conditions

Operating Temperature Range	-40 – 105 °C [-40 – 221 °F]
-----------------------------	-----------------------------

Operation/Application

Circuit Application	Power & Signal
---------------------	----------------

Industry Standards

RAST Version	02-A
Glow Wire Rating	Glow Wire
UL Flammability Rating	UL 94V-2

Packaging Features

Packaging Quantity	6000
Packaging Method	Box

Product Compliance

[For compliance documentation, visit the product page on TE.com>](#)

EU RoHS Directive 2011/65/EU	Compliant
EU ELV Directive 2000/53/EC	Compliant
China RoHS 2 Directive MIIT Order No 32, 2016	No Restricted Materials Above Threshold



EU REACH Regulation (EC) No. 1907/2006

Current ECHA Candidate List: JUNE 2023 (235)

Candidate List Declared Against: JUNE 2023 (235)

Does not contain REACH SVHC

Halogen Content

Not Low Halogen - contains Br or Cl > 900 ppm.

Solder Process Capability

Not applicable for solder process capability

Product Compliance Disclaimer

This information is provided based on reasonable inquiry of our suppliers and represents our current actual knowledge based on the information they provided. This information is subject to change. The part numbers that TE has identified as EU RoHS compliant have a maximum concentration of 0.1% by weight in homogenous materials for lead, hexavalent chromium, mercury, PBB, PBDE, DBP, BBP, DEHP, DIBP, and 0.01% for cadmium, or qualify for an exemption to these limits as defined in the Annexes of Directive 2011/65/EU (RoHS2). Finished electrical and electronic equipment products will be CE marked as required by Directive 2011/65/EU. Components may not be CE marked. Additionally, the part numbers that TE has identified as EU ELV compliant have a maximum concentration of 0.1% by weight in homogenous materials for lead, hexavalent chromium, and mercury, and 0.01% for cadmium, or qualify for an exemption to these limits as defined in the Annexes of Directive 2000/53/EC (ELV). Regarding the REACH Regulation, the information TE provides on SVHC in articles for this part number is based on the latest European Chemicals Agency (ECHA) 'Guidance on requirements for substances in articles' posted at this URL: <https://echa.europa.eu/guidance-documents/guidance-on-reach>

Compatible Parts



TE Part # 9-1241961-2
STD TIM HOUSING MKII 2POS



TE Part # 6-1241983-2
STANDARD TIMER HOUSING MARK II



TE Part # 4-1241965-2
STD TIMER HOUSING



TE Part # 5-1241983-3
STANDARD TIMER HOUSING MARK II



TE Part # 964450-3
POS MATE TAB HOUSING 14POS RED



TE Part # 1241965-4
STANDARD TIMER HSG. WITH EXT. LOCK.



TE Part # 2-1241965-7
7P ST-TIMER GEH



TE Part # 1969352-2
ASSY DIN R/A RAST5 HDR 02-A, G



Also in the Series | RAST 5 IDC Connectors

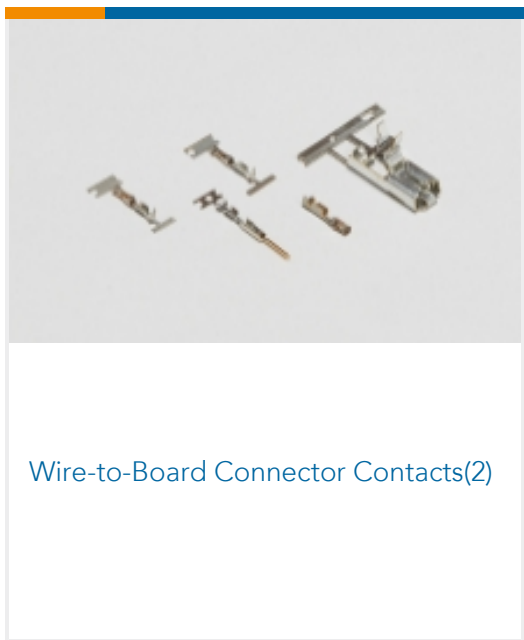
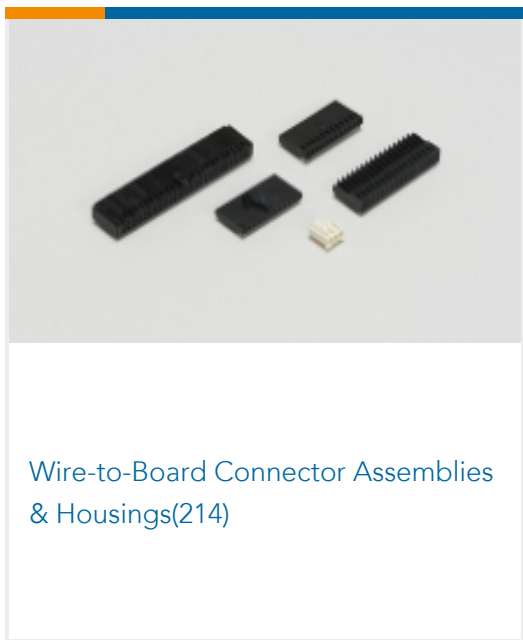
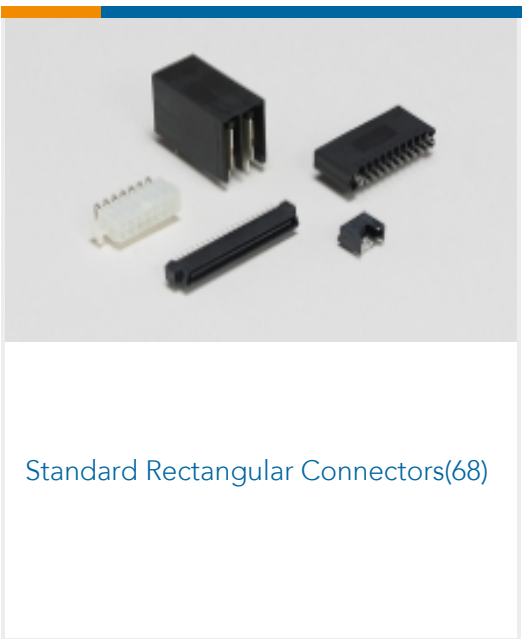
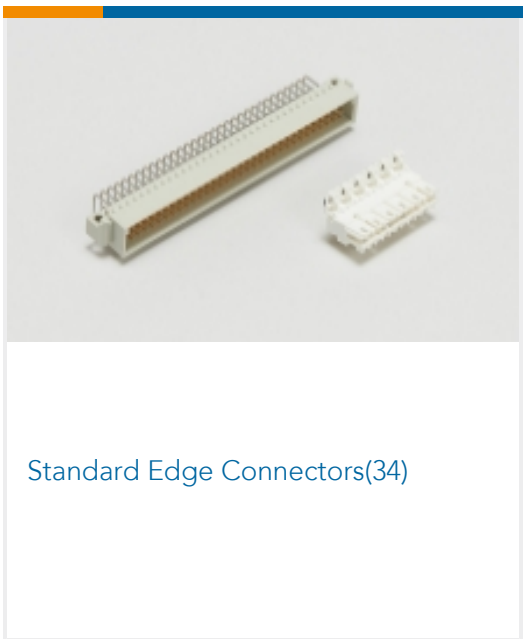
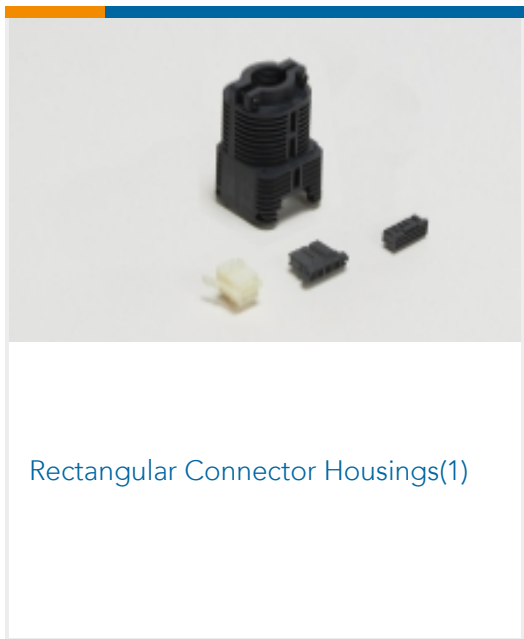
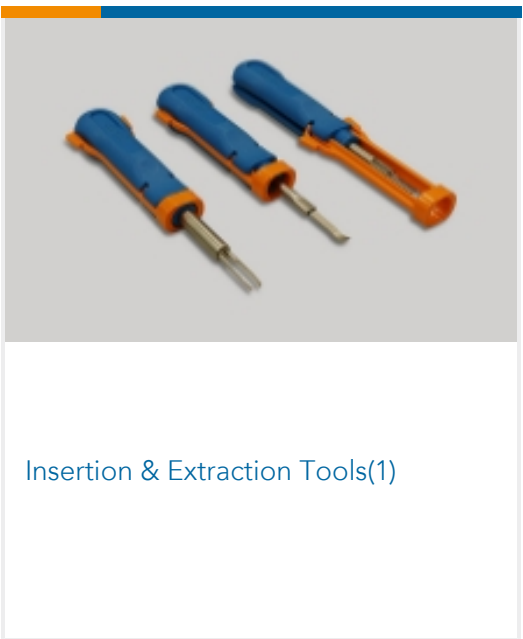
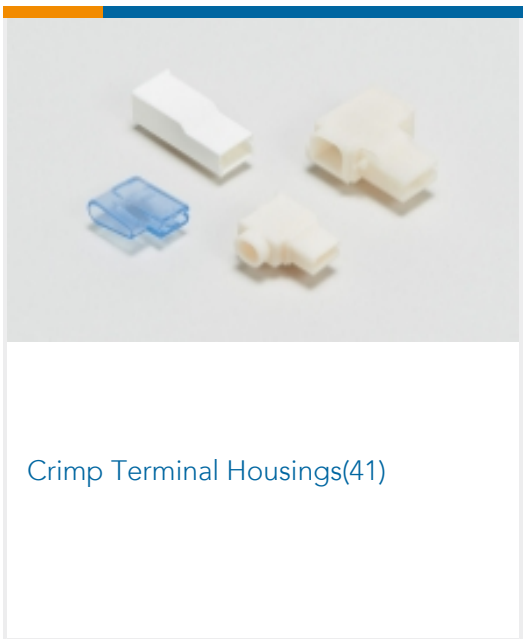
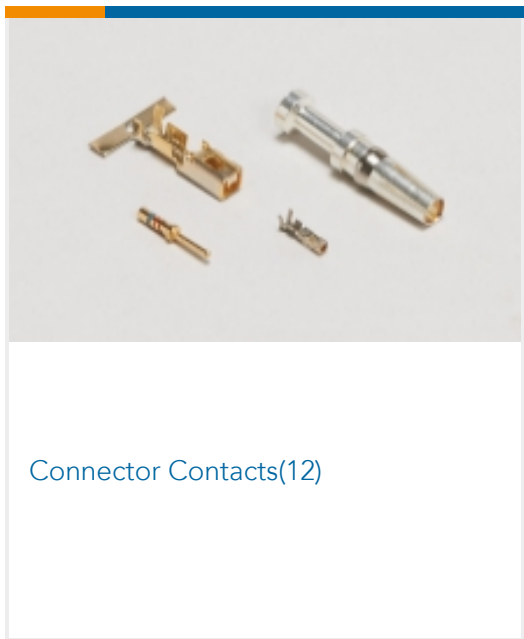
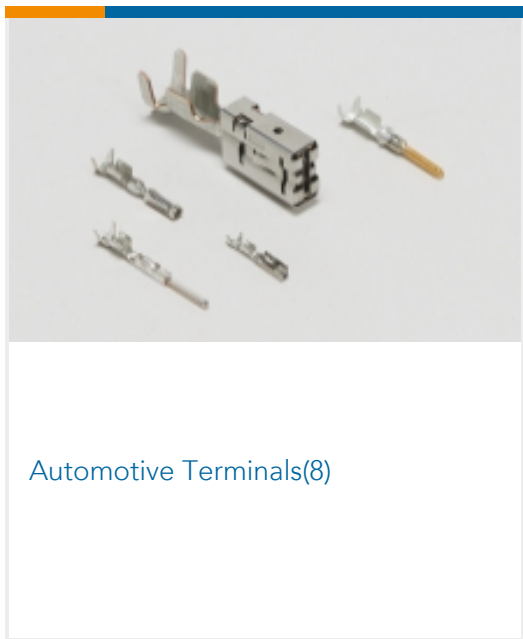

Customers Also Bought



TE Part #185311-1
6POS MOS REC



TE Part #926681-3
12P UNIV.CAP HSG.

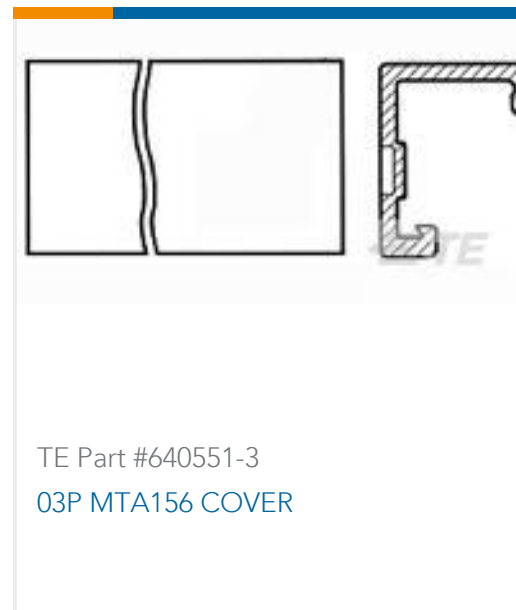

TE Part #640551-3
03P MTA156 COVER



TE Part #927231-7
UMNL 9 WAY CAP HOUSING



TE Part #163555-6
MATENLOK PIN



TE Part #953382-1
COVER FOR 6W HSG MOS GEN2



TE Part #953381-1
LOCKING DEVICE FOR 6W MOS



TE Part #964201-1
STD TIMER CONTACT



TE Part #1734205-1
MINI USB, TYPE B, PLUG. CABLE-KIT



TE Part #1418844-1
MCON 1.2 CB REC SWS SN

Documents

Product Drawings

STD TIMER HOUSING 2POS

English

CAD Files

3D PDF

3D

Customer View Model

[ENG_CVM_CVM_1241965-2_B.2d_dxf.zip](#)

English

Customer View Model

[ENG_CVM_CVM_1241965-2_B.3d_igs.zip](#)

English

Customer View Model

[ENG_CVM_CVM_1241965-2_B.3d_stp.zip](#)

English

By downloading the CAD file I accept and agree to the [Terms and Conditions](#) of use.

Product Specifications



Product Specification

German

Product Environmental Compliance

[MD_1241965-2_062920151254_dmtec](#)

English

[MD_1241965-2_062920151254_dmtec](#)

English