



Is Now Part of



**ON Semiconductor®**

To learn more about ON Semiconductor, please visit our website at  
[www.onsemi.com](http://www.onsemi.com)

Please note: As part of the Fairchild Semiconductor integration, some of the Fairchild orderable part numbers will need to change in order to meet ON Semiconductor's system requirements. Since the ON Semiconductor product management systems do not have the ability to manage part nomenclature that utilizes an underscore (\_), the underscore (\_) in the Fairchild part numbers will be changed to a dash (-). This document may contain device numbers with an underscore (\_). Please check the ON Semiconductor website to verify the updated device numbers. The most current and up-to-date ordering information can be found at [www.onsemi.com](http://www.onsemi.com). Please email any questions regarding the system integration to [Fairchild\\_questions@onsemi.com](mailto:Fairchild_questions@onsemi.com).

ON Semiconductor and the ON Semiconductor logo are trademarks of Semiconductor Components Industries, LLC dba ON Semiconductor or its subsidiaries in the United States and/or other countries. ON Semiconductor owns the rights to a number of patents, trademarks, copyrights, trade secrets, and other intellectual property. A listing of ON Semiconductor's product/patent coverage may be accessed at [www.onsemi.com/site/pdf/Patent-Marking.pdf](http://www.onsemi.com/site/pdf/Patent-Marking.pdf). ON Semiconductor reserves the right to make changes without further notice to any products herein. ON Semiconductor makes no warranty, representation or guarantee regarding the suitability of its products for any particular purpose, nor does ON Semiconductor assume any liability arising out of the application or use of any product or circuit, and specifically disclaims any and all liability, including without limitation special, consequential or incidental damages. Buyer is responsible for its products and applications using ON Semiconductor products, including compliance with all laws, regulations and safety requirements or standards, regardless of any support or applications information provided by ON Semiconductor. "Typical" parameters which may be provided in ON Semiconductor data sheets and/or specifications can and do vary in different applications and actual performance may vary over time. All operating parameters, including "Typicals" must be validated for each customer application by customer's technical experts. ON Semiconductor does not convey any license under its patent rights nor the rights of others. ON Semiconductor products are not designed, intended, or authorized for use as a critical component in life support systems or any FDA Class 3 medical devices or medical devices with a same or similar classification in a foreign jurisdiction or any devices intended for implantation in the human body. Should Buyer purchase or use ON Semiconductor products for any such unintended or unauthorized application, Buyer shall indemnify and hold ON Semiconductor and its officers, employees, subsidiaries, affiliates, and distributors harmless against all claims, costs, damages, and expenses, and reasonable attorney fees arising out of, directly or indirectly, any claim of personal injury or death associated with such unintended or unauthorized use, even if such claim alleges that ON Semiconductor was negligent regarding the design or manufacture of the part. ON Semiconductor is an Equal Opportunity/Affirmative Action Employer. This literature is subject to all applicable copyright laws and is not for resale in any manner.

# FAN73901

## High- and Low-Side, Gate-Drive IC

### Features

- Floating Channels for Bootstrap Operation to +600 V
- Typically 2.5 A / 2.5 A Sourcing/Sinking Current Driving Capability
- Common-Mode dv/dt Noise Canceling Circuit
- Built-in Under-Voltage Lockout for Both Channels
- Matched Propagation Delay for Both Channels
- 3.3 V and 5 V Input Logic Compatible
- Output In-Phase with Input

### Applications

- Half-Bridge Driver
- HID Lamp Ballast
- SMPS
- Motor Driver

### Description

The FAN73901 is a monolithic high- and low-side gate-drive IC, which can drive high-speed MOSFETs and IGBTs that operate up to +600 V. It has a buffered output stage with all NMOS transistors designed for high pulse current driving capability and minimum cross-conduction.

Fairchild's high-voltage process and common-mode noise canceling techniques provide stable operation of the high-side driver under high dv/dt noise circumstances. An advanced level-shift circuit offers high-side gate driver operation up to  $V_S = -9.8$  V (typical) for  $V_{BS} = 15$  V.

The UVLO circuit prevents malfunction when  $V_{DD}$  and  $V_{BS}$  are lower than the specified threshold voltage.

The high current and low output voltage drop features make sFAN73901 suitable for switching power supply, motor driver, and high-power DC-DC converter applications.

8-SOP



### Ordering Information

Part Number	Package	Operating Temperature Range	Packing Method
FAN73901M	8-SOP	-40°C ~ 125°C	Tube
FAN73901MX			Tape & Reel

### Typical Application Circuit

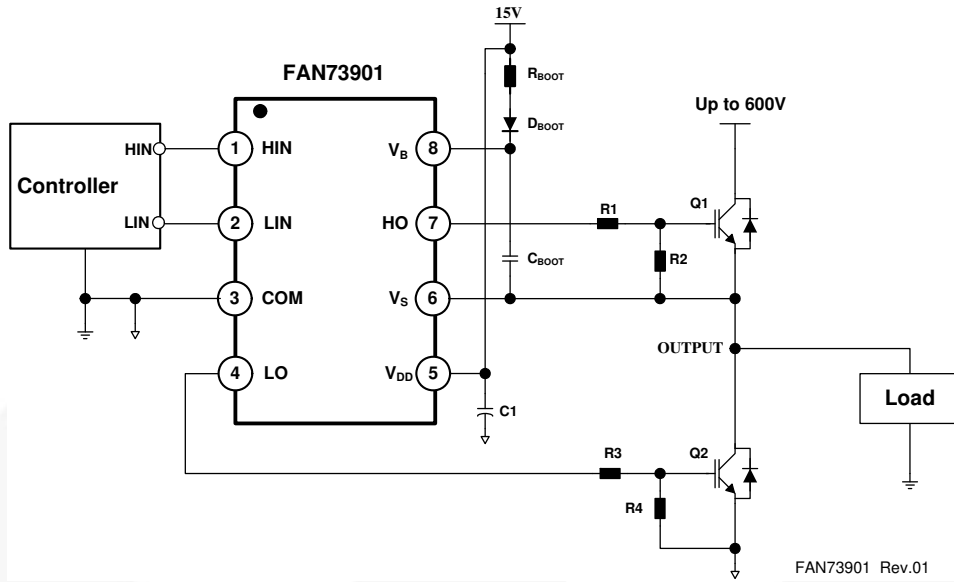

Figure 1. Application Circuit for Half-Bridge

### Internal Block Diagram

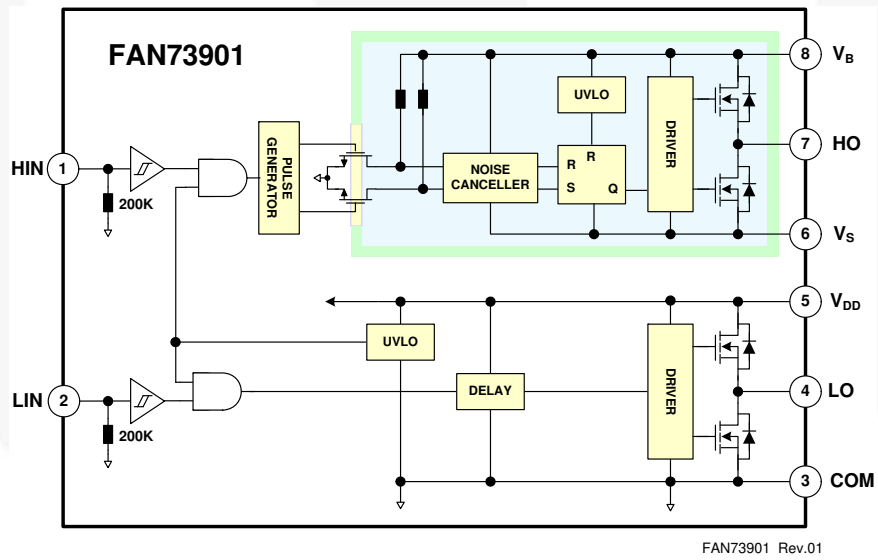
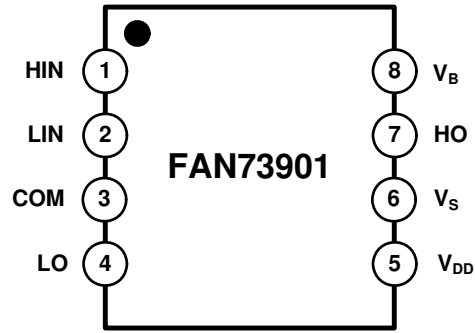

Figure 2. Functional Block Diagram

## Pin Configuration



FAN73901 Rev.01

Figure 3. Pin Assignments (Top View)

## Pin Definitions

Pin #	Name	Description
1	HIN	Logic Input for High-Side Gate Driver Output
2	LIN	Logic Input for Low-Side Gate Driver Output
3	COM	Low-Side Driver Return
4	LO	Low-Side Driver Output
5	V <sub>DD</sub>	Low-Side and Logic Part Supply Voltage
6	V <sub>S</sub>	High-Voltage Floating Supply Return
7	HO	High-Side Driver Output
8	V <sub>B</sub>	High-Side Floating Supply

## Absolute Maximum Ratings

Stresses exceeding the absolute maximum ratings may damage the device. The device may not function or be operable above the recommended operating conditions and stressing the parts to these levels is not recommended. In addition, extended exposure to stresses above the recommended operating conditions may affect device reliability. The absolute maximum ratings are stress ratings only.  $T_A=25^{\circ}\text{C}$ , unless otherwise specified.

Symbol	Characteristics	Min.	Max.	Unit
$V_S$	High-Side Floating Supply Offset Voltage	$V_B-25$	$V_B+0.3$	V
$V_B$	High-Side Floating Supply Voltage	-0.3	625.0	V
$V_{HO}$	High-Side Floating Output Voltage HO	$V_S-0.3$	$V_B+0.3$	V
$V_{DD}$	Low-Side and Logic Fixed Supply Voltage	-0.3	25.0	V
$V_{LO}$	Low-Side Output Voltage LO	-0.3	$V_{DD}+0.3$	V
$V_{IN}$	Logic Input Voltage (HIN and LIN)	-0.3	$V_{DD}+0.3$	V
$dV_S/dt$	Allowable Offset Voltage Slew Rate		50	V/ns
$P_D$	Power Dissipation <sup>(1)(2)(3)</sup>		0.625	W
$\theta_{JA}$	Thermal Resistance, Junction-to-Ambient		200	$^{\circ}\text{C}/\text{W}$
$T_J$	Junction Temperature		+150	$^{\circ}\text{C}$
$T_{STG}$	Storage Temperature		+150	$^{\circ}\text{C}$

### Notes:

- Mounted on 76.2 x 114.3 x 1.6 mm PCB (FR-4 glass epoxy material).
- Refer to the following standards:
  - JESD51-2: Integral circuits thermal test method environmental conditions - natural convection
  - JESD51-3: Low effective thermal conductivity test board for leaded surface mount packages.
- Do not exceed  $P_D$  under any circumstances.

## Recommended Operating Conditions

The Recommended Operating Conditions table defines the conditions for actual device operation. Recommended operating conditions are specified to ensure optimal performance to the datasheet specifications. Fairchild does not recommend exceeding them or designing to absolute maximum ratings.

Symbol	Parameter	Min.	Max.	Unit
$V_B$	High-Side Floating Supply Voltage	$V_S+10$	$V_S+20$	V
$V_S$	High-Side Floating Supply Offset Voltage	$6-V_{DD}$	600	V
$V_{HO}$	High-Side Output Voltage	$V_S$	$V_B$	V
$V_{DD}$	Low-Side and Logic Supply Voltage	10	20	V
$V_{LO}$	Low-Side Output Voltage	COM	$V_{DD}$	V
$V_{IN}$	Logic Input Voltage (HIN and LIN)	COM	$V_{DD}$	V
$T_A$	Operating Ambient Temperature	-40	+125	$^{\circ}\text{C}$

## Electrical Characteristics

$V_{BIAS}$  ( $V_{DD}$ ,  $V_{BS}$ )=15.0 V,  $V_S$ =COM,  $T_A$ =25°C, unless otherwise specified. The  $V_{IL}$ ,  $V_{IH}$ , and  $I_{IN}$  parameters are referenced to COM and are applicable to the respective input signals HIN and LIN. The  $V_O$  and  $I_O$  parameters are referenced to COM and  $V_S$  is applicable to the respective output signals HO and LO.

Symbol	Characteristics	Test Condition	Min.	Typ.	Max.	Unit
<b>POWER SUPPLY SECTION (<math>V_{DD}</math> AND <math>V_{BS}</math>)</b>						
$V_{DDUV+}$ $V_{BSUV+}$	$V_{DD}$ and $V_{BS}$ Supply Under-Voltage Positive-Going Threshold		8.0	8.8	9.8	V
$V_{DDUV-}$ $V_{BSUV-}$	$V_{DD}$ and $V_{BS}$ Supply Under-Voltage Negative-Going Threshold		7.4	8.3	9.0	V
$V_{DDUVH}$ $V_{BSUVH}$	$V_{DD}$ and $V_{BS}$ Supply Under-Voltage Lockout Hysteresis Voltage			0.5		V
$I_{LK}$	Offset Supply Leakage Current	$V_B=V_S=600$ V			50	$\mu$ A
$I_{QBS}$	Quiescent $V_{BS}$ Supply Current	$V_{IN}=0$ V or 5 V		45	80	$\mu$ A
$I_{QDD}$	Quiescent $V_{DD}$ Supply Current	$V_{IN}=0$ V or 5 V		75	110	$\mu$ A
$I_{PBS}$	Operating $V_{BS}$ Supply Current	$f_{IN}=20$ kHz, rms value		530	640	$\mu$ A
$I_{PDD}$	Operating $V_{DD}$ Supply Current	$f_{IN}=20$ kHz, rms value		530	640	$\mu$ A
<b>LOGIC INPUT SECTION (HIN, LIN)</b>						
$V_{IH}$	Logic "1" Input Voltage		2.5			V
$V_{IL}$	Logic "0" Input Voltage				1.2	V
$I_{IN+}$	Logic "1" Input Bias Current	$V_{IN}=5$ V		25	50	$\mu$ A
$I_{IN-}$	Logic "0" Input Bias Current	$V_{IN}=0$ V		1.0	2.0	$\mu$ A
$R_{IN}$	Input Pull-Down Resistance		100	200		K $\Omega$
<b>GATE DRIVER OUTPUT SECTION (HO, LO)</b>						
$V_{OH}$	High-Level Output Voltage, $V_{BIAS}-V_O$	No Load			1.0	V
$V_{OL}$	Low-Level Output Voltage, $V_O$	No Load			35	mV
$I_{O+}$	Output High, Short-Circuit Pulsed Current <sup>(4)</sup>	$V_O=0$ V, $V_{IN}=5$ V with $PW<10$ $\mu$ s	1.8	2.5		A
$I_{O-}$	Output Low, Short-Circuit Pulsed Current <sup>(4)</sup>	$V_O=15$ V, $V_{IN}=0$ V with $PW<10$ $\mu$ s	1.8	2.5		A
$V_S$	Allowable Negative $V_S$ Pin Voltage for HIN Signal Propagation to HO			-9.8	-7.0	V

**Note:**

4. This parameter guaranteed by design.

## Dynamic Electrical Characteristics

$V_{BIAS}$  ( $V_{DD}$ ,  $V_{BS}$ )=15.0 V,  $V_S$ =COM=0 V,  $C_L$ =1000 pF and  $T_A$ =25°C unless otherwise specified.

Symbol	Characteristics	Test Condition	Min.	Typ.	Max.	Unit
$t_{on}$	Turn-on Propagation Delay	$V_S=0$ V		140	200	ns
$t_{off}$	Turn-off Propagation Delay	$V_S=0$ V		140	200	ns
MT	Delay Matching, HS & LS Turn-on/off			0	50	ns
$t_r$	Turn-on Rise Time			25	50	ns
$t_f$	Turn-off Fall Time			20	45	ns

## Typical Characteristics

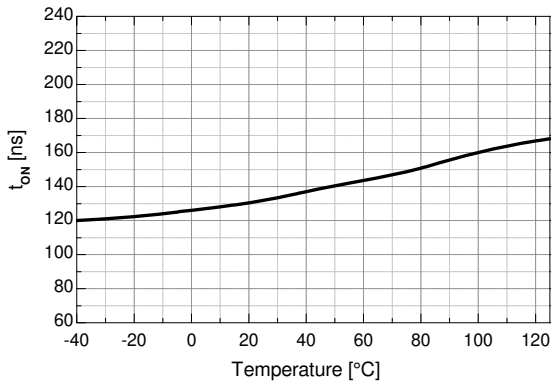

Figure 4. Turn-on Propagation Delay vs. Temperature

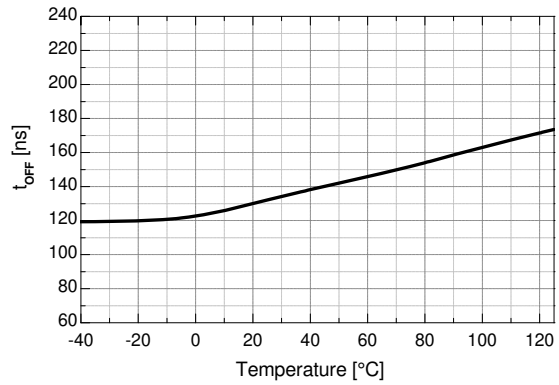

Figure 5. Turn-off Propagation Delay vs. Temperature

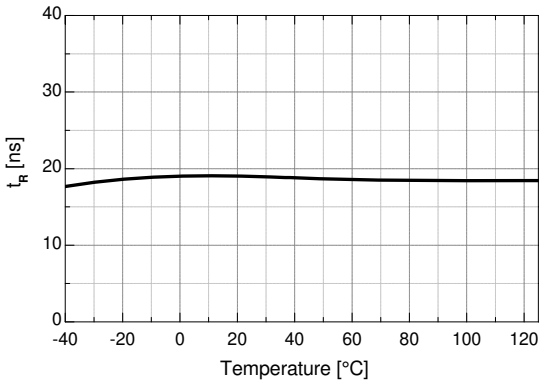

Figure 6. Turn-on Rise Time vs. Temperature

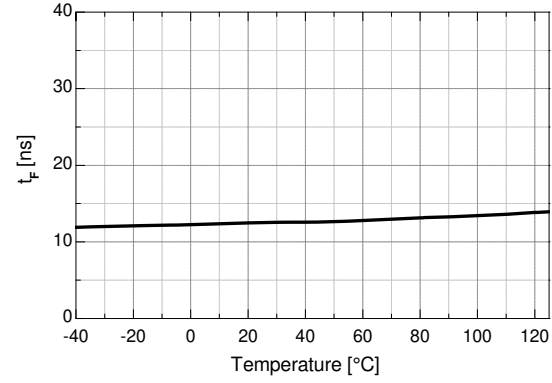

Figure 7. Turn-off Fall Time vs. Temperature

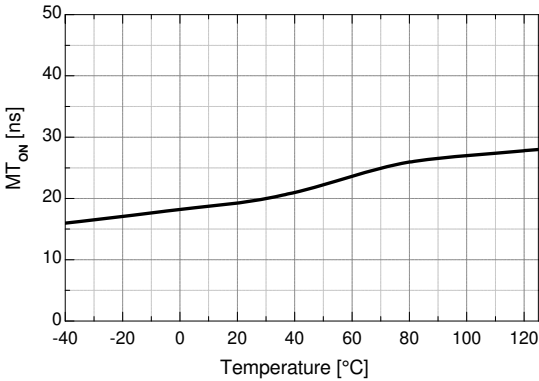

Figure 8. Turn-on Delay Matching vs. Temperature

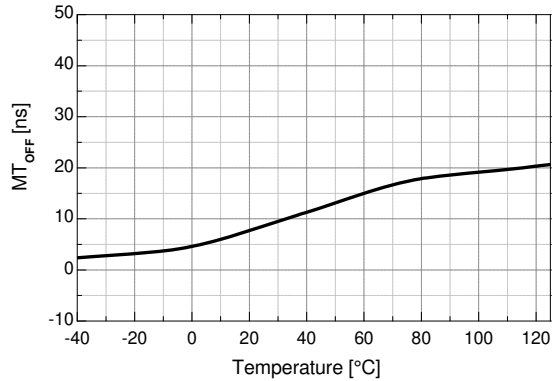

Figure 9. Turn-off Delay Matching vs. Temperature

Typical Characteristics (Continued)

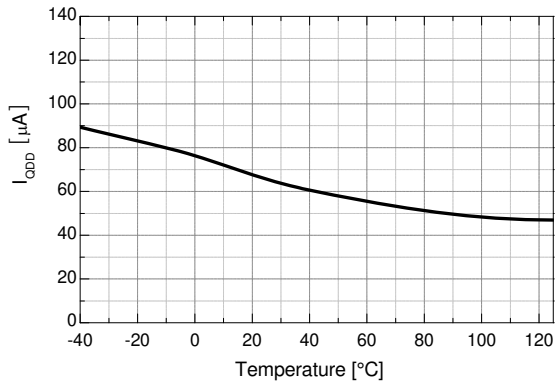

Figure 10. Quiescent  $V_{DD}$  Supply Current vs. Temperature

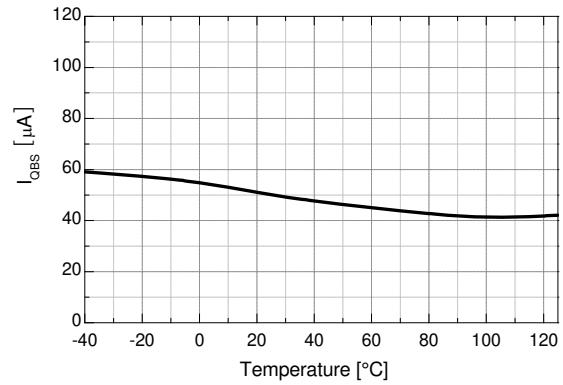

Figure 11. Quiescent  $V_{BS}$  Supply Current vs. Temperature

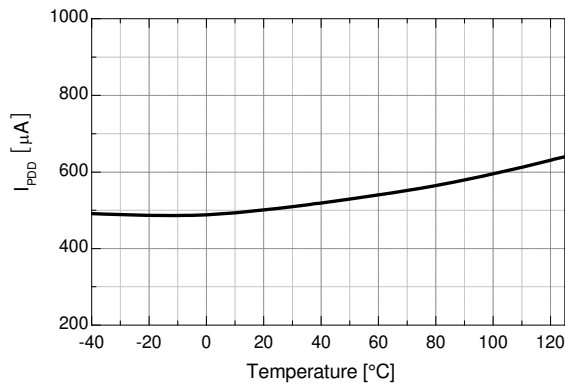

Figure 12. Operating  $V_{DD}$  Supply Current vs. Temperature

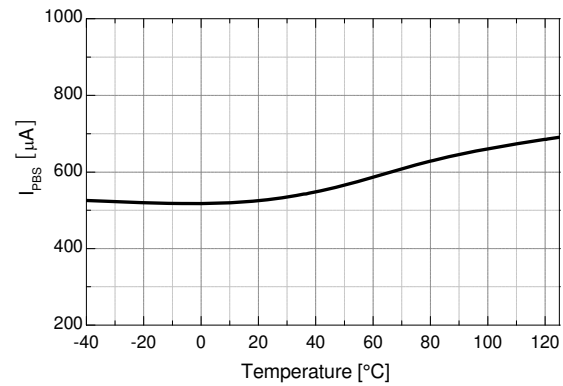

Figure 13. Operating  $V_{BS}$  Supply Current vs. Temperature

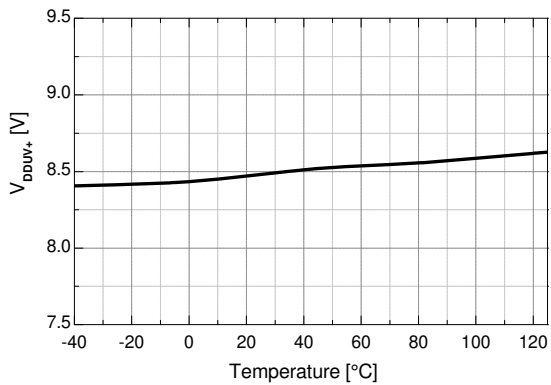

Figure 14.  $V_{DD}$  UVLO+ vs. Temperature

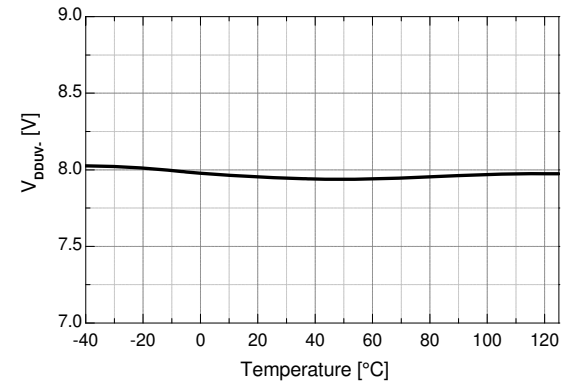

Figure 15.  $V_{DD}$  UVLO- vs. Temperature



Typical Characteristics (Continued)

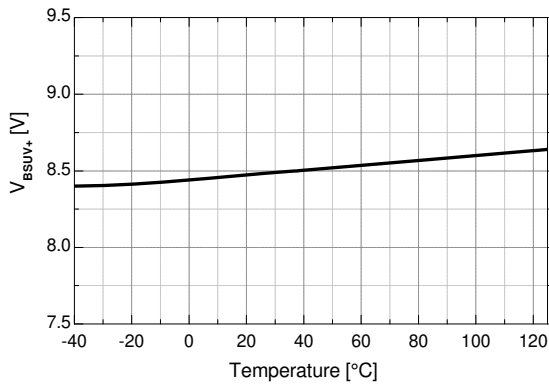

Figure 16.  $V_{BS}$  UVLO+ vs. Temperature

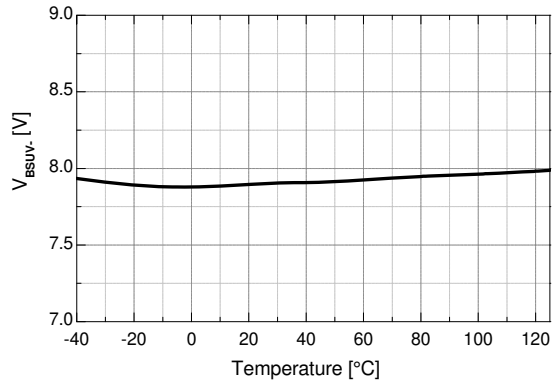

Figure 17.  $V_{BS}$  UVLO- vs. Temperature

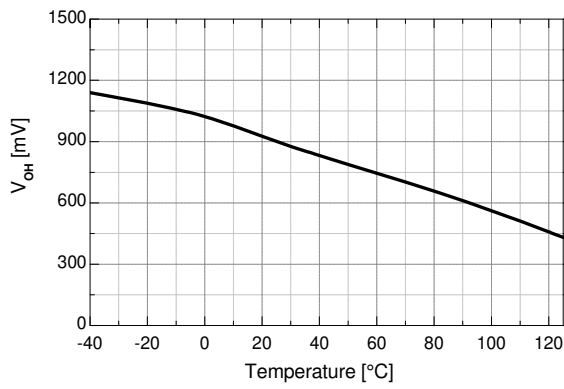

Figure 18. High-Level Output Voltage vs. Temperature

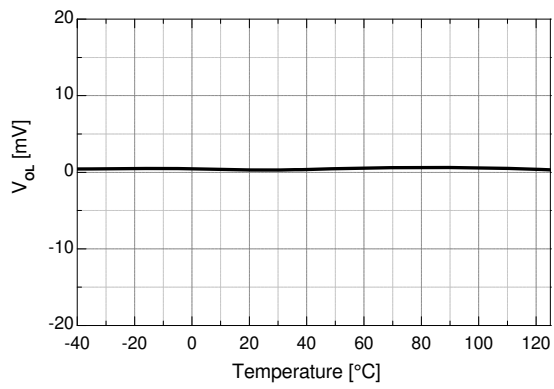

Figure 19. Low-Level Output Voltage vs. Temperature

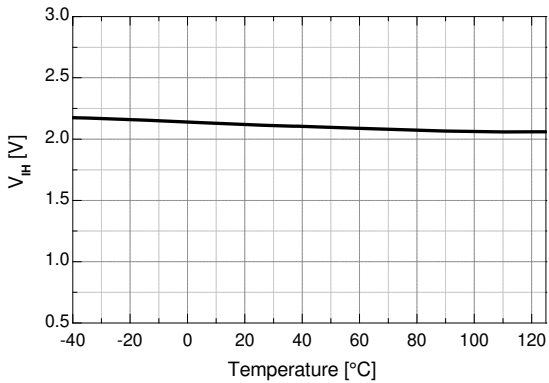

Figure 20. Logic High Input Voltage vs. Temperature

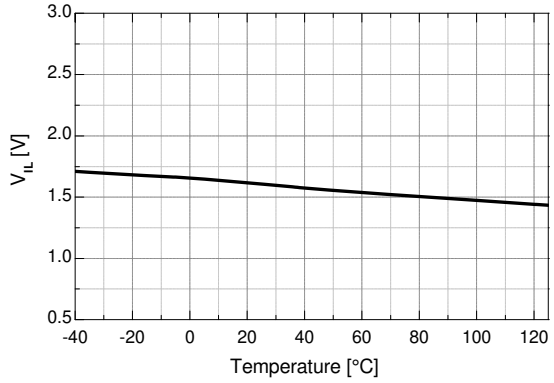

Figure 21. Logic Low Input Voltage vs. Temperature

Typical Characteristics (Continued)

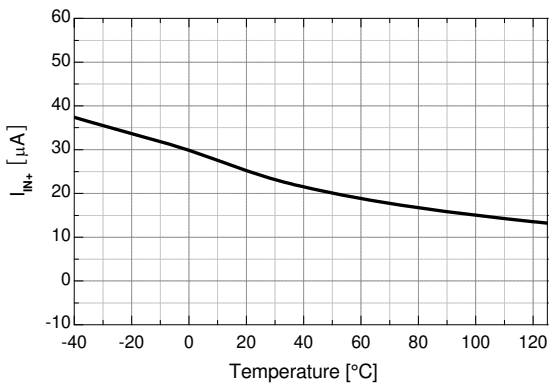

Figure 22. Logic Input High Bias Current vs. Temperature

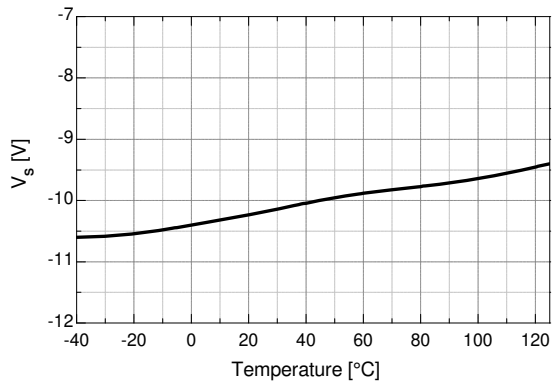

Figure 23. Allowable Negative  $V_S$  Voltage vs. Temperature

## Switching Time Definitions

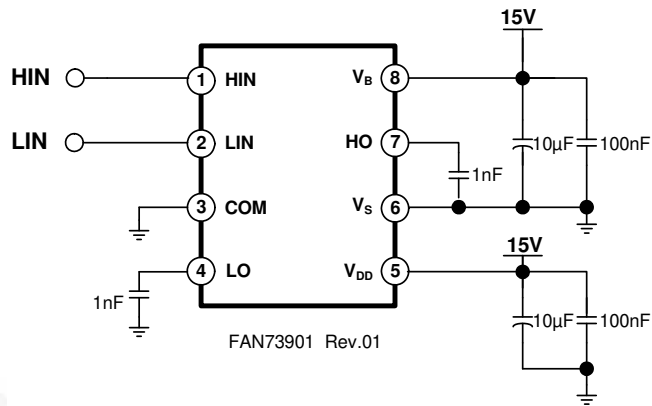

Figure 24. Switching Time Test Circuit

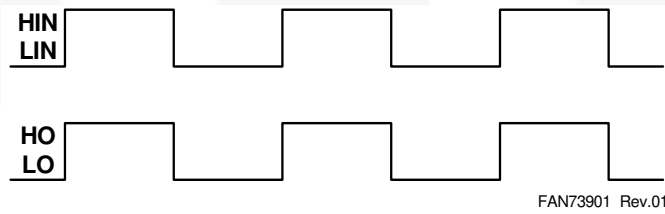

Figure 25. Input / Output Timing Diagram

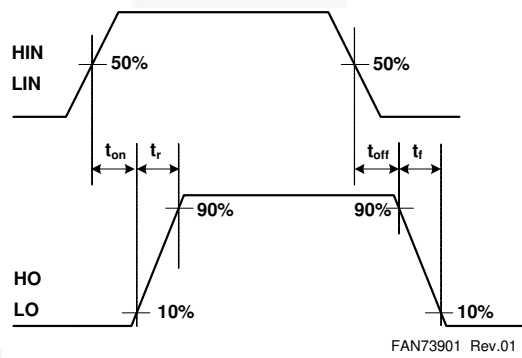

Figure 26. Switching Time Waveform Definitions

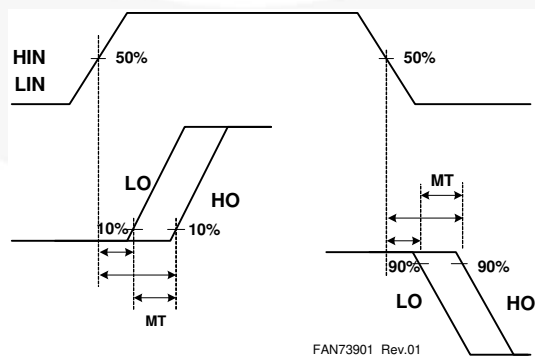
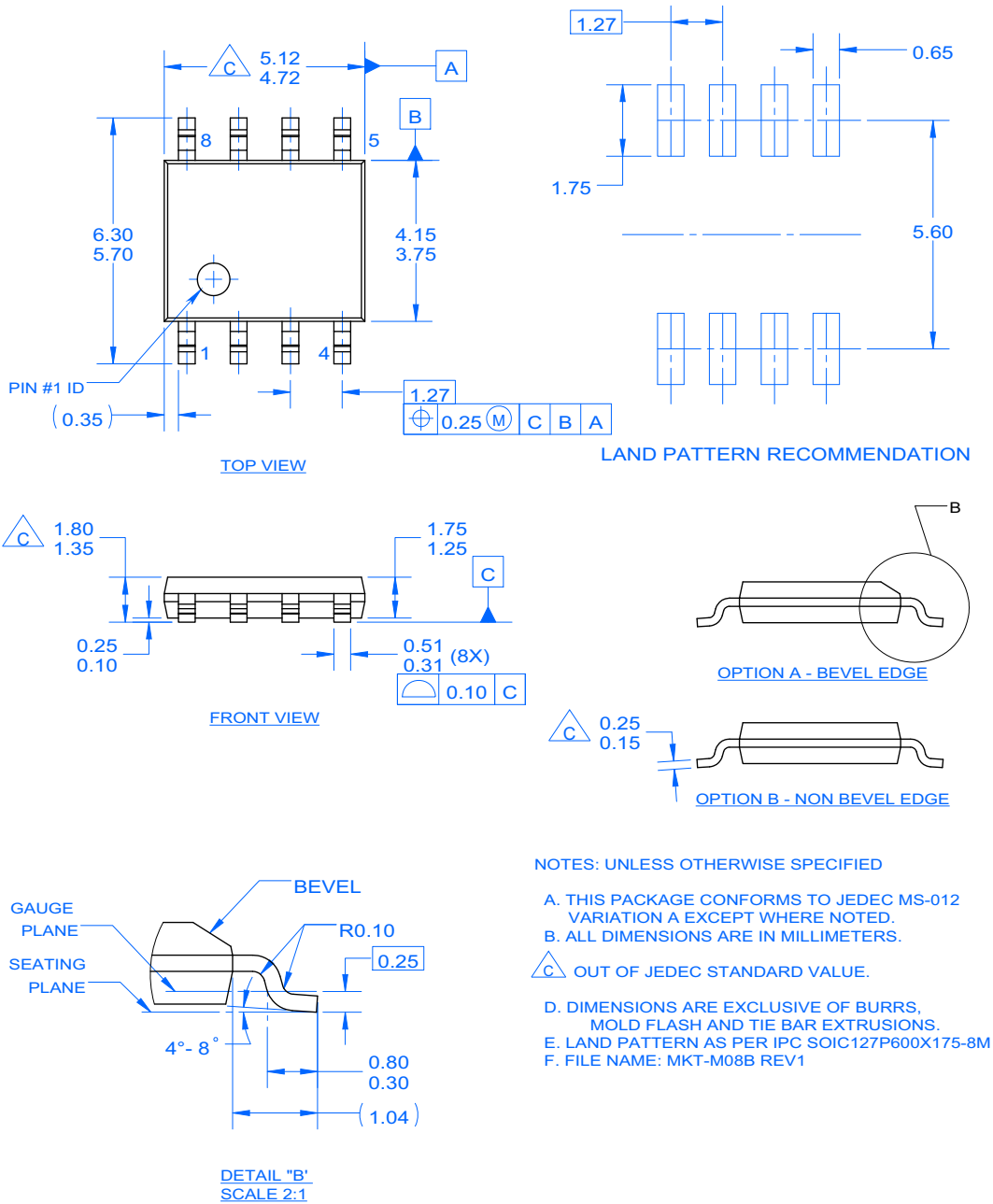

Figure 27. Delay Matching Waveform Definitions

## Mechanical Dimensions



**Figure 28. 8-Lead Small Outline Package (SOP)**

Package drawings are provided as a service to customers considering Fairchild components. Drawings may change in any manner without notice. Please note the revision and/or date on the drawing and contact a Fairchild Semiconductor representative to verify or obtain the most recent revision. Package specifications do not expand the terms of Fairchild's worldwide terms and conditions, specifically the warranty therein, which covers Fairchild products.





Always visit Fairchild Semiconductor's online packaging area for the most recent package drawings:

<http://www.fairchildsemi.com/dwg/M0/M08B.pdf>



### TRADEMARKS

The following includes registered and unregistered trademarks and service marks, owned by Fairchild Semiconductor and/or its global subsidiaries, and is not intended to be an exhaustive list of all such trademarks.

- |   |  |   |   |
|---|--|---|---|
| AccuPower™  | F-PFS™   |    | Sync-Lock™  |
| AX-CAP®*  | FRFET®   | PowerTrench®  |  SYSTEM GENERAL® |
| BitSiC™   | Global Power Resource™                         | PowerXS™  | TinyBoost®  |
| Build it Now™   | GreenBridge™                                   | Programmable Active Droop™  | TinyBuck®   |
| CorePLUS™   | Green FPS™                                     | QFET®   | TinyCalc™   |
| CorePOWER™  | Green FPS™ e-Series™                           | QS™   | TinyLogic®  |
| CROSSVOLT™  | Gmax™  | Quiet Series™   | TINYOPTO™   |
| CTL™  | GTO™   | RapidConfigure™   | TinyPower™  |
| Current Transfer Logic™   | IntelliMAX™                                    |  ™ | TinyPWM™  |
| DEUXPEED®   | ISOPLANAR™                                     | Saving our world, 1mW/W/kW at a time™   | TinyWire™   |
| Dual Cool™  | Making Small Speakers Sound Louder and Better™ | SignalWise™   | TranSiC™  |
| EcoSPARK®   | MegaBuck™                                      | SmartMax™   | TriFault Detect™  |
| EfficientMax™   | MICROCOUPLER™                                  | SMART START™  | TRUECURRENT®*   |
| ESBC™   | MicroFET™                                      | Solutions for Your Success™   | μSerDes™  |
|  | MicroPak™                                      | SPM®  |  SerDes™         |
| Fairchild®  | MicroPak2™                                     | STEALTH™  | UHC®  |
| Fairchild Semiconductor®  | MillerDrive™                                   | SuperFET®   | Ultra FRFET™  |
| FACT Quiet Series™  | MotionMax™                                     | SuperSOT™-3   | UniFET™   |
| FACT®   | mWSaver®                                       | SuperSOT™-6   | VCX™  |
| FAST®   | OptoHi™  | SuperSOT™-8   | VisualMax™  |
| FastvCore™  | OPTOLOGIC®                                     | SupreMOS®   | VoltagePlus™  |
| FETBench™   | OPTOPLANAR®                                    | SyncFET™  | XS™   |
| FPS™  |  |   |   |

\* Trademarks of System General Corporation, used under license by Fairchild Semiconductor.

### DISCLAIMER

FAIRCHILD SEMICONDUCTOR RESERVES THE RIGHT TO MAKE CHANGES WITHOUT FURTHER NOTICE TO ANY PRODUCTS HEREIN TO IMPROVE RELIABILITY, FUNCTION, OR DESIGN. FAIRCHILD DOES NOT ASSUME ANY LIABILITY ARISING OUT OF THE APPLICATION OR USE OF ANY PRODUCT OR CIRCUIT DESCRIBED HEREIN; NEITHER DOES IT CONVEY ANY LICENSE UNDER ITS PATENT RIGHTS, NOR THE RIGHTS OF OTHERS. THESE SPECIFICATIONS DO NOT EXPAND THE TERMS OF FAIRCHILD'S WORLDWIDE TERMS AND CONDITIONS, SPECIFICALLY THE WARRANTY THEREIN, WHICH COVERS THESE PRODUCTS.

### LIFE SUPPORT POLICY

FAIRCHILD'S PRODUCTS ARE NOT AUTHORIZED FOR USE AS CRITICAL COMPONENTS IN LIFE SUPPORT DEVICES OR SYSTEMS WITHOUT THE EXPRESS WRITTEN APPROVAL OF FAIRCHILD SEMICONDUCTOR CORPORATION.

As used herein:

- Life support devices or systems are devices or systems which, (a) are intended for surgical implant into the body or (b) support or sustain life, and (c) whose failure to perform when properly used in accordance with instructions for use provided in the labeling, can be reasonably expected to result in a significant injury of the user.
- A critical component in any component of a life support, device, or system whose failure to perform can be reasonably expected to cause the failure of the life support device or system, or to affect its safety or effectiveness.

### ANTI-COUNTERFEITING POLICY

Fairchild Semiconductor Corporation's Anti-Counterfeiting Policy. Fairchild's Anti-Counterfeiting Policy is also stated on our external website, [www.fairchildsemi.com](http://www.fairchildsemi.com), under Sales Support.

Counterfeiting of semiconductor parts is a growing problem in the industry. All manufacturers of semiconductor products are experiencing counterfeiting of their parts. Customers who inadvertently purchase counterfeit parts experience many problems such as loss of brand reputation, substandard performance, failed applications, and increased cost of production and manufacturing delays. Fairchild is taking strong measures to protect ourselves and our customers from the proliferation of counterfeit parts. Fairchild strongly encourages customers to purchase Fairchild parts either directly from Fairchild or from Authorized Fairchild Distributors who are listed by country on our web page cited above. Products customers buy either from Fairchild directly or from Authorized Fairchild Distributors are genuine parts, have full traceability, meet Fairchild's quality standards for handling and storage and provide access to Fairchild's full range of up-to-date technical and product information. Fairchild and our Authorized Distributors will stand behind all warranties and will appropriately address any warranty issues that may arise. Fairchild will not provide any warranty coverage or other assistance for parts bought from Unauthorized Sources. Fairchild is committed to combat this global problem and encourage our customers to do their part in stopping this practice by buying direct or from authorized distributors.

### PRODUCT STATUS DEFINITIONS

#### Definition of Terms

Datasheet Identification	Product Status	Definition
Advance Information	Formative / In Design	Datasheet contains the design specifications for product development. Specifications may change in any manner without notice.
Preliminary	First Production	Datasheet contains preliminary data; supplementary data will be published at a later date. Fairchild Semiconductor reserves the right to make changes at any time without notice to improve design.
No Identification Needed	Full Production	Datasheet contains final specifications. Fairchild Semiconductor reserves the right to make changes at any time without notice to improve the design.
Obsolete	Not In Production	Datasheet contains specifications on a product that is discontinued by Fairchild Semiconductor. The datasheet is for reference information only.

Rev. I66

ON Semiconductor and  are trademarks of Semiconductor Components Industries, LLC dba ON Semiconductor or its subsidiaries in the United States and/or other countries. ON Semiconductor owns the rights to a number of patents, trademarks, copyrights, trade secrets, and other intellectual property. A listing of ON Semiconductor's product/patent coverage may be accessed at [www.onsemi.com/site/pdf/Patent-Marking.pdf](http://www.onsemi.com/site/pdf/Patent-Marking.pdf). ON Semiconductor reserves the right to make changes without further notice to any products herein. ON Semiconductor makes no warranty, representation or guarantee regarding the suitability of its products for any particular purpose, nor does ON Semiconductor assume any liability arising out of the application or use of any product or circuit, and specifically disclaims any and all liability, including without limitation special, consequential or incidental damages. Buyer is responsible for its products and applications using ON Semiconductor products, including compliance with all laws, regulations and safety requirements or standards, regardless of any support or applications information provided by ON Semiconductor. "Typical" parameters which may be provided in ON Semiconductor data sheets and/or specifications can and do vary in different applications and actual performance may vary over time. All operating parameters, including "Typicals" must be validated for each customer application by customer's technical experts. ON Semiconductor does not convey any license under its patent rights nor the rights of others. ON Semiconductor products are not designed, intended, or authorized for use as a critical component in life support systems or any FDA Class 3 medical devices or medical devices with a same or similar classification in a foreign jurisdiction or any devices intended for implantation in the human body. Should Buyer purchase or use ON Semiconductor products for any such unintended or unauthorized application, Buyer shall indemnify and hold ON Semiconductor and its officers, employees, subsidiaries, affiliates, and distributors harmless against all claims, costs, damages, and expenses, and reasonable attorney fees arising out of, directly or indirectly, any claim of personal injury or death associated with such unintended or unauthorized use, even if such claim alleges that ON Semiconductor was negligent regarding the design or manufacture of the part. ON Semiconductor is an Equal Opportunity/Affirmative Action Employer. This literature is subject to all applicable copyright laws and is not for resale in any manner.

## PUBLICATION ORDERING INFORMATION

### LITERATURE FULFILLMENT:

Literature Distribution Center for ON Semiconductor  
19521 E. 32nd Pkwy, Aurora, Colorado 80011 USA  
**Phone:** 303-675-2175 or 800-344-3860 Toll Free USA/Canada  
**Fax:** 303-675-2176 or 800-344-3867 Toll Free USA/Canada  
**Email:** [orderlit@onsemi.com](mailto:orderlit@onsemi.com)

**N. American Technical Support:** 800-282-9855 Toll Free  
USA/Canada  
**Europe, Middle East and Africa Technical Support:**  
Phone: 421 33 790 2910  
**Japan Customer Focus Center**  
Phone: 81-3-5817-1050

**ON Semiconductor Website:** [www.onsemi.com](http://www.onsemi.com)  
**Order Literature:** <http://www.onsemi.com/orderlit>  
For additional information, please contact your local  
Sales Representative