



GARDTEC

Part Number:

SC162-W5

Material: C1008 Steel
Finish: Bright Nickel Chrome Plating
Ring Diameter: 1.8mm
Rib Diameter: 2.3mm
General Tolerance Unless Noted: ± 0.5 mm
Unit: mm
RoHS/REACH Compliant

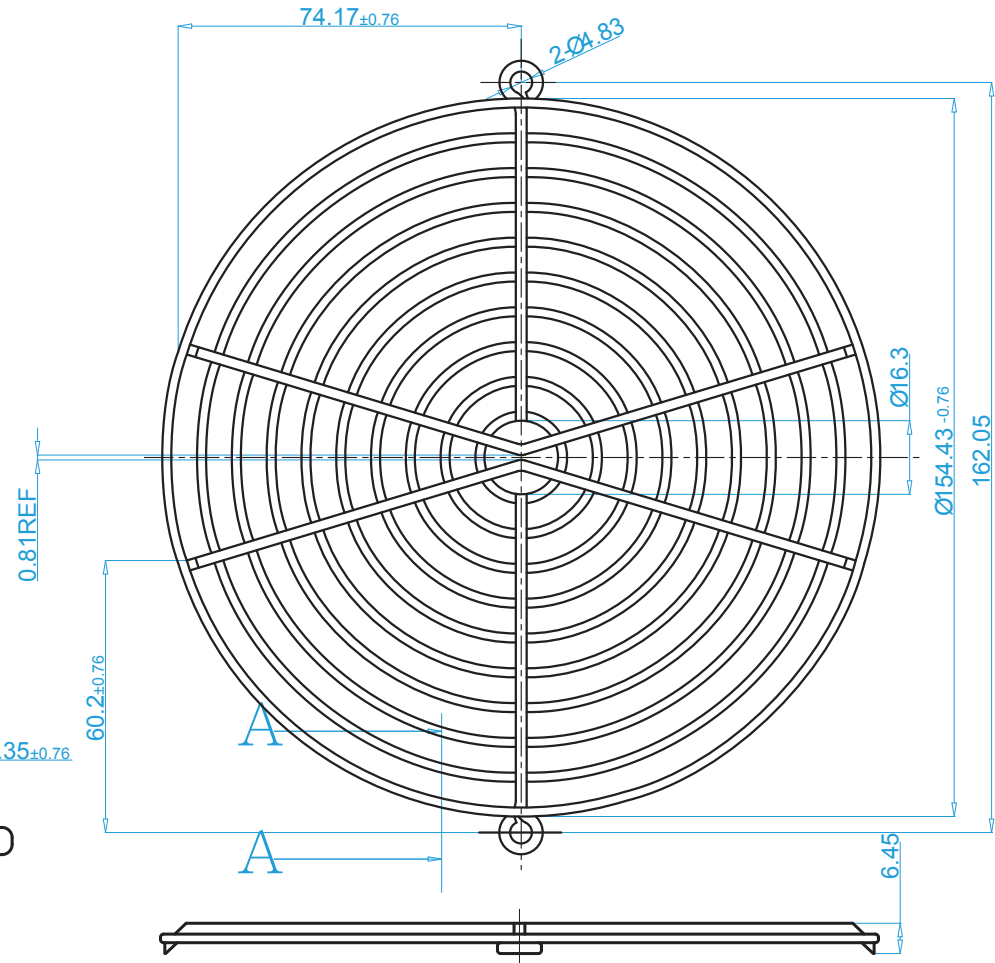
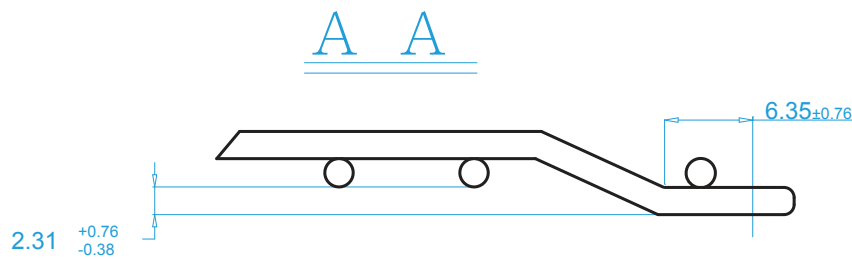

These drawings are the property of Gardtec, Inc and cannot be reproduced for or communicated to a third party without the express written permission of Gardtec, Inc.