

## STRADA-T-DN

Beam for area lighting with shorter illumination distances optimized for CREE XP-G and XP-E. Assembly with installation tape.

### SPECIFICATION:

Dimensions	19.6 x 15.5 mm
Height	8.8 mm
Fastening	tape, pin, screw
ROHS compliant	yes ⓘ



### MATERIALS:

Component	Type	Material	Colour	Finish
STRADA-T-DN	Single lens	PMMA	clear	
VOSU-WU-M-365-TAPE	Tape	Acrylic foam		

### ORDERING INFORMATION:

Component		Qty in box	MOQ	MPQ	Box weight (kg)
CA11416_STRADA-T-DN	Single lens	3360	240	240	5.6
» Box size: 451 x 273 x 197 mm					

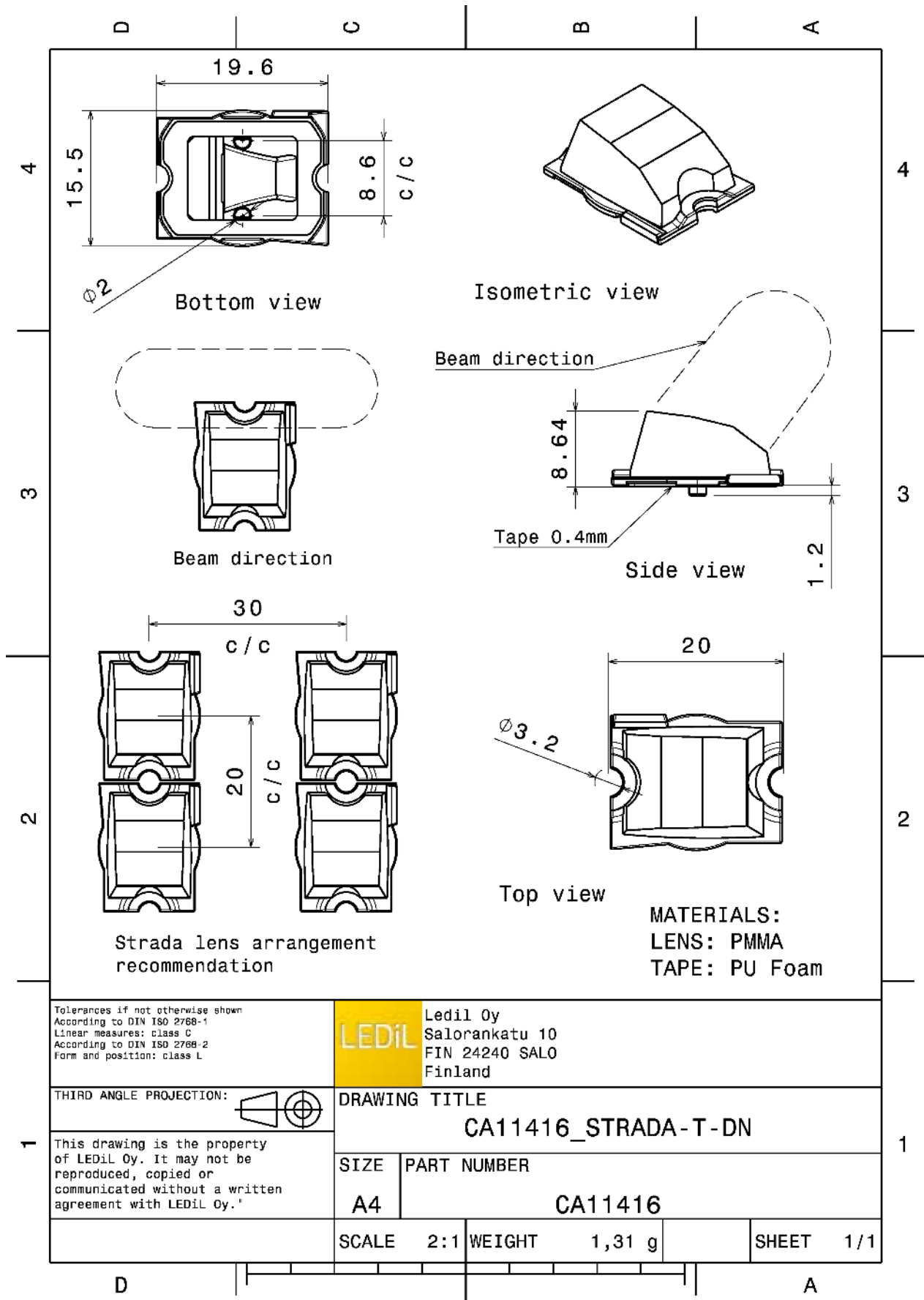

Tolerances if not otherwise shown  
According to DIN ISO 2768-1  
Linear measures: class C  
According to DIN ISO 2768-2  
Form and position: class L



Ledil Oy  
Salorankatu 10  
FIN 24240 SALO  
Finland

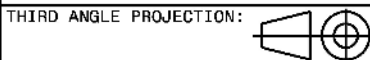

DRAWING TITLE

CA11416\_STRADA-T-DN

This drawing is the property of LEDiL Oy. It may not be reproduced, copied or communicated without a written agreement with LEDiL Oy.

SIZE PART NUMBER

A4

CA11416

SCALE 2:1 WEIGHT 1,31 g

SHEET 1/1

See also our general installation guide: [www.ledil.com/installation\\_guide](http://www.ledil.com/installation_guide)

### OPTICAL RESULTS (MEASURED):

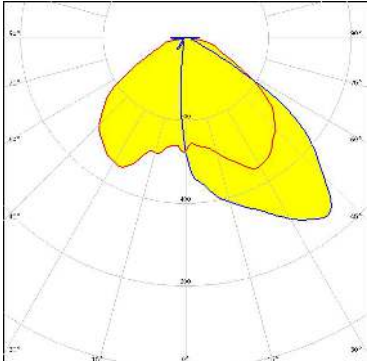
<p><b>CREE → LED</b></p> <p>LED                    XB-D            FWHM / FWTM      Asymmetric            Efficiency            91 %            LEDs/each optic    1            Light colour         White            Required components:</p>	
<p><b>CREE → LED</b></p> <p>LED                    XP-E            FWHM / FWTM      Asymmetric            Efficiency            92 %            LEDs/each optic    1            Light colour         White            Required components:</p>	
<p><b>CREE → LED</b></p> <p>LED                    XP-G            FWHM / FWTM      Asymmetric            Efficiency            92 %            LEDs/each optic    1            Light colour         White            Required components:</p>	
<p><b>LUMILEDS</b></p> <p>LED                    LUXEON A            FWHM / FWTM      Asymmetric            Efficiency            92 %            LEDs/each optic    1            Light colour         White            Required components:</p>	

### OPTICAL RESULTS (MEASURED):

#### LUMILEDS

LED LUXEON Rebel  
 FWHM / FWTM Asymmetric  
 Efficiency 92 %  
 LEDs/each optic 1  
 Light colour White  
 Required components:

#### LUMILEDS

LED LUXEON Rebel ES  
 FWHM / FWTM Asymmetric  
 Efficiency 92 %  
 LEDs/each optic 1  
 Light colour White  
 Required components:

#### LUMILEDS

LED LUXEON TX  
 FWHM / FWTM Asymmetric  
 Efficiency 91 %  
 Peak intensity 0.5 cd/lm  
 LEDs/each optic 1  
 Light colour White  
 Required components:

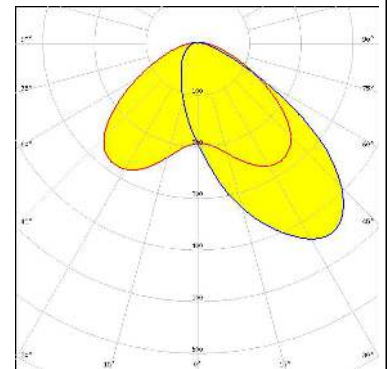

#### LUMILEDS

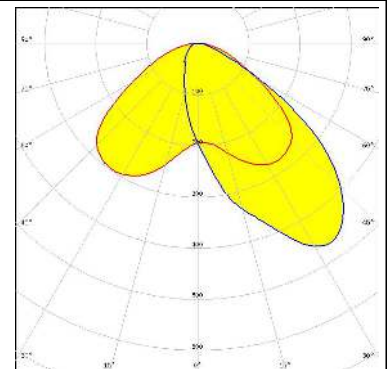

LED LUXEON Z ES  
 FWHM / FWTM Asymmetric  
 Efficiency 90 %  
 Peak intensity 0.5 cd/lm  
 LEDs/each optic 1  
 Light colour White  
 Required components:

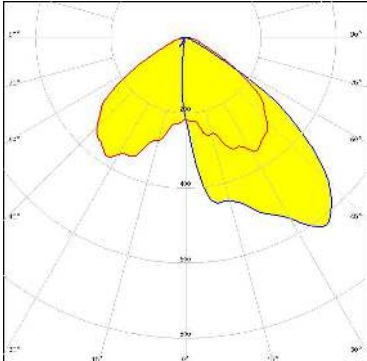
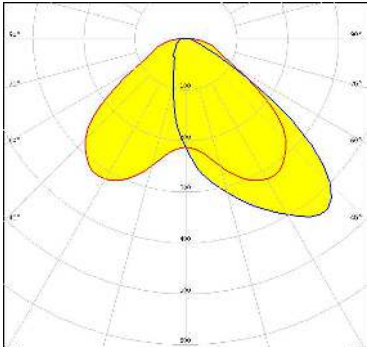

### OPTICAL RESULTS (MEASURED):

<p><b>NICHIA</b></p> <p>LED                    NCSxx19A            FWHM / FWTM    Asymmetric            Efficiency         92 %            LEDs/each optic   1            Light colour       White            Required components:</p>	
<p><b>NICHIA</b></p> <p>LED                    NVSxx19A            FWHM / FWTM    Asymmetric            Efficiency         92 %            LEDs/each optic   1            Light colour       White            Required components:</p>	
<p><b>OSRAM</b>  <small>Opto Semiconductors</small></p> <p>LED                    OSLOM Square PC            FWHM / FWTM    Asymmetric            Efficiency         93 %            LEDs/each optic   1            Light colour       White            Required components:</p>	
<p><b>OSRAM</b>  <small>Opto Semiconductors</small></p> <p>LED                    OSLOM SSL 150            FWHM / FWTM    Asymmetric            Efficiency         92 %            LEDs/each optic   1            Light colour       White            Required components:</p>	

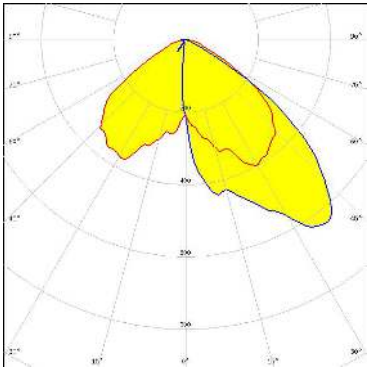
### OPTICAL RESULTS (MEASURED):

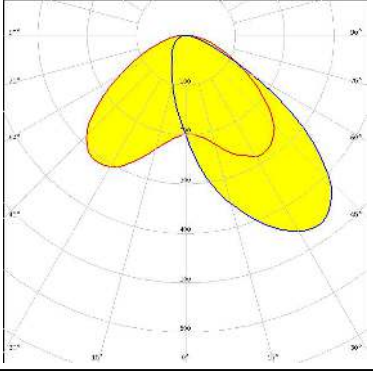
<p> SEOUL SEMICONDUCTOR</p> <p>LED Z5            FWHM / FWTM Asymmetric            Efficiency 92 %            LEDs/each optic 1            Light colour White            Required components:</p>	
<p> SEOUL SEMICONDUCTOR</p> <p>LED Z5M1/Z5M2            FWHM / FWTM Asymmetric            Efficiency 92 %            Peak intensity 0.5 cd/lm            LEDs/each optic 1            Light colour White            Required components:</p>	
<p><b>SHARP</b></p> <p>LED Double Dome (GM2BB)            FWHM / FWTM Asymmetric            Efficiency 92 %            LEDs/each optic 1            Light colour White            Required components:</p>	

### OPTICAL RESULTS (SIMULATED):

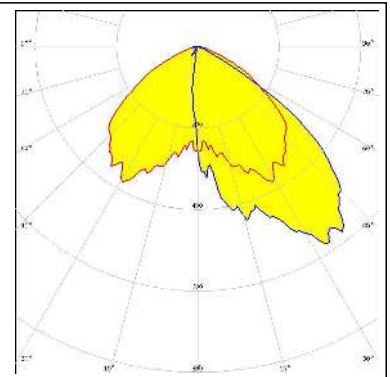
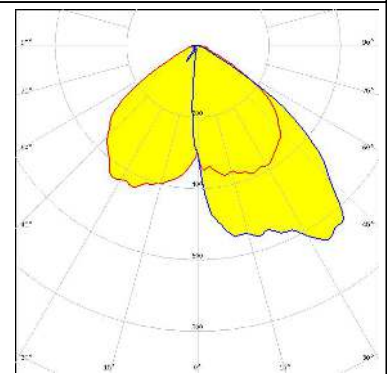
<p><b>LUMILEDS</b></p> <p>LED: LUXEON T            FWHM / FWTM: Asymmetric            Efficiency: 91 %            LEDs/each optic: 1            Light colour: White            Required components:</p>	
<p><b>NICHIA</b></p> <p>LED: NVSxx19B/NVSxx19C            FWHM / FWTM: Asymmetric            Efficiency: 90 %            LEDs/each optic: 1            Light colour: White            Required components:</p>	
<p><b>OSRAM</b>  <small>Opto Semiconductors</small></p> <p>LED: OSOLON SSL 80            FWHM / FWTM: Asymmetric            Efficiency: 93 %            Peak intensity: 0.7 cd/lm            LEDs/each optic: 1            Light colour: White            Required components:</p>	

### GENERAL INFORMATION:

NOTE: The typical beam angle will be changed by different color, chip size and chip position tolerance. The typical total beam angle is the full angle measured where the luminous intensity is half of the peak value.

### MATERIALS:

As part of our continuous research and improvement processes, and to ensure the best possible quality and availability of our products, LEDiL reserves the right to change material grades without notice.

### PRODUCT DATA USER AGREEMENT AND DISCLAIMER:

The measured data in the provided downloadable LEDiL Product Datasheets and Mechanical 2D-Drawings is rounded and provided as reference for planning. LEDiL Oy's optical specifications have been verified by conducting performance testing of the products in accordance with the company's quality system. The reported data are averaged results of multiple measurements with typical variation. LEDiL Oy reserves the right to without prior notification make changes and improvements to its products.

LEDiL Oy assumes neither warranty, nor guarantee nor any other liability of any kind for the contents and correctness of the provided data. The provided data has been generated with highest diligence but the provided data may in reality not represent the complete possible variation range of all intrinsic parameters. Therefore, in certain cases a deviation from the provided data could occur.

LEDiL Oy reserves the right to undertake technical changes of its products without further notification which could lead to changes in the provided data. LEDiL Oy assumes no liability of any kind for the possible deviation from any provided data or any other damage resulting from the usage of the provided data.

The user agrees to this disclaimer and user agreement with the download or usage of the provided files.

#### LEDiL Oy

Joensuunkatu 13  
FI-24240 SALO  
Finland

#### LEDiL Inc.

228 West Page Street  
Suite D  
Sycamore IL 60178  
USA

#### Ledil Optics Technology (Shenzhen) Co., Ltd.

# 405 , Block B  
Casic Motor Building  
Shenzhen 518057  
P.R.CHINA

#### Local sales and technical support

[www.ledil.com/  
where\\_to\\_buy](http://www.ledil.com/where_to_buy)

#### Shipping locations

Salo, Finland  
Hong Kong, China

#### Distribution Partners

[www.ledil.com/  
where\\_to\\_buy](http://www.ledil.com/where_to_buy)