

# Heterojunction Bipolar Transistor Technology (InGaP HBT)

## Broadband High Linearity Amplifier

The MMG3005NT1 is a general purpose amplifier that is internally prematched and designed for a broad range of Class A, small-signal, high linearity, general purpose applications. It is suitable for applications with frequencies from 800 to 2200 MHz such as cellular, PCS, WLL, PHS, VHF, UHF, UMTS and general small-signal RF.

### Features

- Frequency: 800–2200 MHz
- P1dB: 30 dBm @ 2140 MHz
- Small-Signal Gain: 15 dB @ 2140 MHz
- Third Order Output Intercept Point: 47 dBm @ 2140 MHz
- Single 5 V Supply
- Internally Prematched to 50 Ohms
- In Tape and Reel. T1 Suffix = 1,000 Units, 16 mm Tape Width, 13-inch Reel.

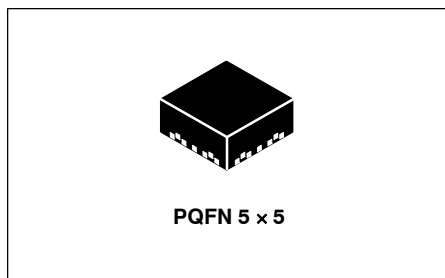
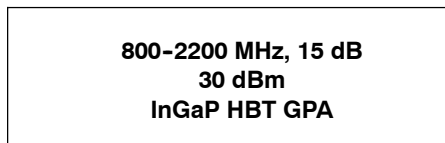


Table 1. Typical Performance <sup>(1)</sup>

Characteristic	Symbol	900 MHz	1960 MHz	2140 MHz	Unit
Small-Signal Gain (S21)	G <sub>p</sub>	18.5	15.5	15	dB
Input Return Loss (S11)	IRL	-14	-10	-11	dB
Output Return Loss (S22)	ORL	-12	-7	-7	dB
Power Output @1dB Compression	P1db	30	30	30	dBm
Third Order Output Intercept Point	OIP3	47	47	47	dBm

1. V<sub>DC</sub> = 5 Vdc, T<sub>A</sub> = 25°C, 50 ohm system, application circuit tuned for specified frequency.

Table 2. Maximum Ratings

Rating	Symbol	Value	Unit
Supply Voltage	V <sub>DC</sub>	6	V
Supply Current	I <sub>DC</sub>	600	mA
RF Input Power	P <sub>in</sub>	18	dBm
Storage Temperature Range	T <sub>stg</sub>	-65 to +150	°C
Junction Temperature	T <sub>J</sub>	150	°C

Table 3. Thermal Characteristics

Characteristic	Symbol	Value <sup>(2)</sup>	Unit
Thermal Resistance, Junction to Case Case Temperature 100°C, 5 Vdc, 480 mA, no RF applied	R <sub>θJC</sub>	21.5	°C/W

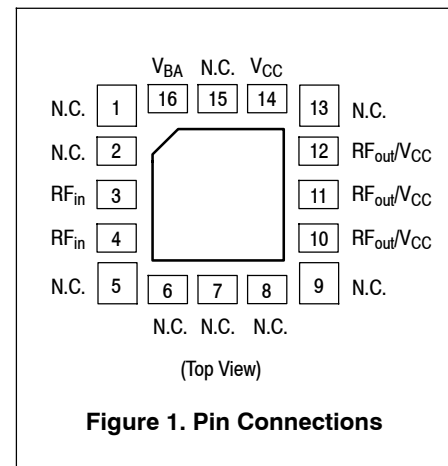
2. Refer to AN1955, *Thermal Measurement Methodology of RF Power Amplifiers*. Go to <http://www.freescale.com/rf>. Select Documentation/Application Notes - AN1955.

**Table 4. Electrical Characteristics** ( $V_{DC} = 5 \text{ Vdc}$ , 2140 MHz,  $T_A = 25^\circ\text{C}$ , 50 ohm system, in Freescale Application Circuit)

Characteristic	Symbol	Min	Typ	Max	Unit
Small-Signal Gain (S21)	$G_p$	14	15	—	dB
Input Return Loss (S11)	IRL	—	-11	—	dB
Output Return Loss (S22)	ORL	—	-7	—	dB
Power Output @ 1dB Compression	P1dB	—	30	—	dBm
Third Order Output Intercept Point	OIP3	—	47	—	dBm
Noise Figure	NF	—	5	—	dB
Supply Current	$I_{DC}$	420	480	520	mA
Supply Voltage	$V_{DC}$	—	5	—	V

**Table 5. Functional Pin Description**

Name	Pin Number	Description
$RF_{in}$	3, 4	RF input for the power amplifier. This pin is DC-coupled and requires a DC-blocking series capacitor.
$RF_{out}/V_{CC}$	10, 11, 12	RF output for the power amplifier. This pin is DC-coupled and requires a DC-blocking series capacitor.
$V_{CC}$	14	Collector voltage supply.
$V_{BA}$	16	Bias voltage supply.
GND	Backside Center Metal	The center metal base of the PQFN package provides both DC and RF ground as well as heat sink contact for the power amplifier.

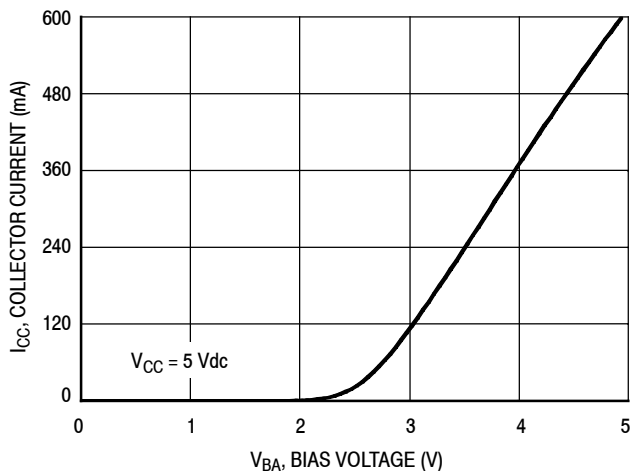

**Table 6. ESD Protection Characteristics**

Test Methodology	Class
Human Body Model (per JESD 22-A114)	1A
Machine Model (per EIA/JESD 22-A115)	A
Charge Device Model (per JESD 22-C101)	IV

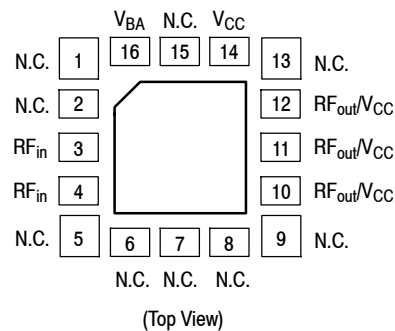
**Table 7. Moisture Sensitivity Level**

Test Methodology	Rating	Package Peak Temperature	Unit
Per JESD 22-A113, IPC/JEDEC J-STD-020	3	260	$^\circ\text{C}$

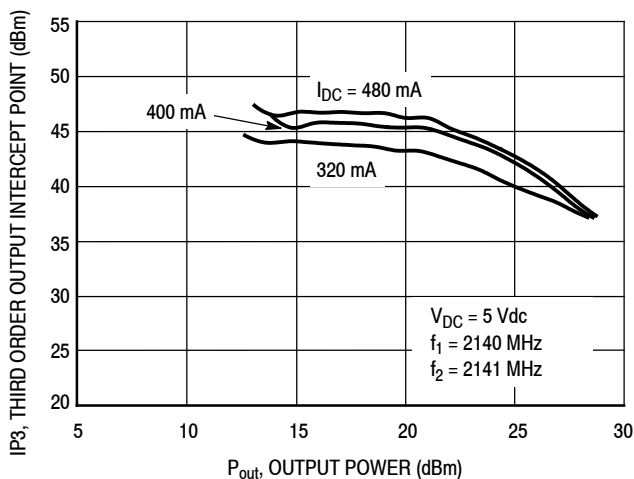
### 50 OHM TYPICAL CHARACTERISTICS



**Figure 2. Collector Current versus Bias Voltage at Pin 16**

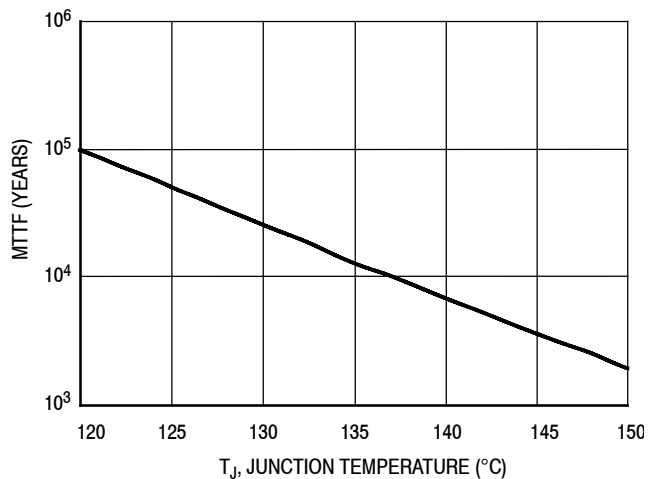


**Pin Connections**



NOTE: Supply current is varied under external resistor control. Peak power is not reduced at any listed current. Similar results can be obtained for other frequency bands.

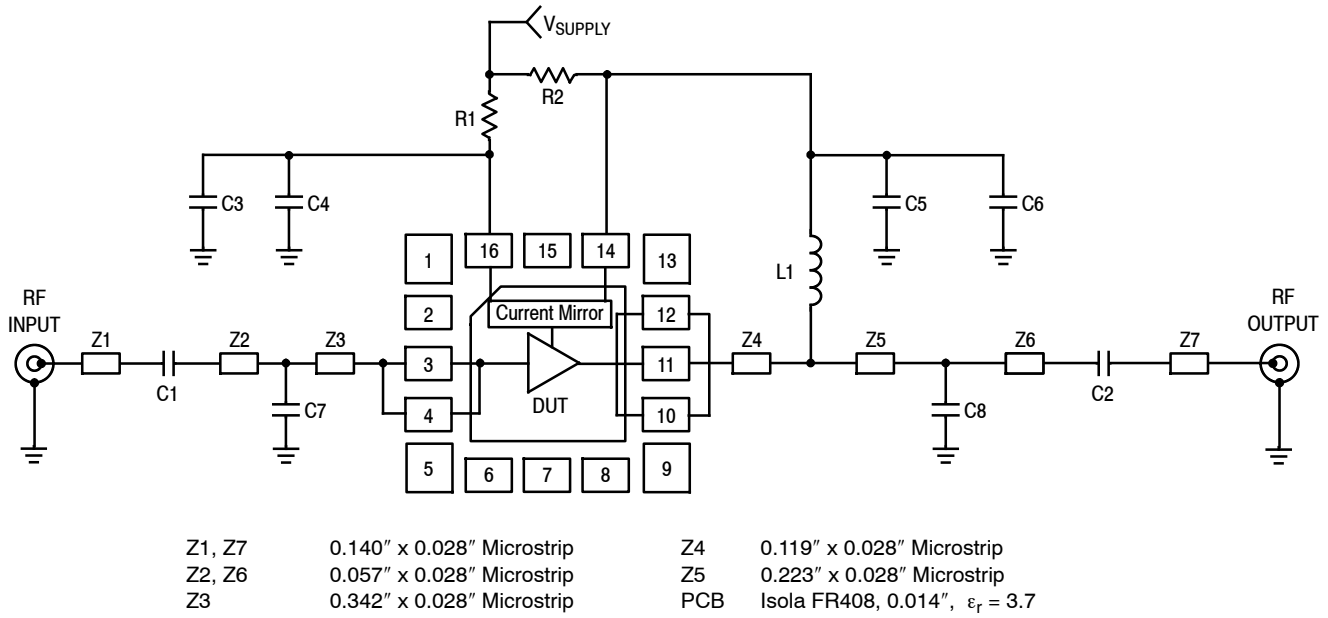
**Figure 3. Third Order Output Intercept Point versus Output Power and Supply Current**



NOTE: The MTTF is calculated with V<sub>DC</sub> = 5 Vdc, I<sub>DC</sub> = 480 mA

**Figure 4. MTTF versus Junction Temperature**

### 50 OHM APPLICATION CIRCUIT: 900 MHz



**Figure 5. 50 Ohm Test Circuit Schematic**

**Table 8. 50 Ohm Test Circuit Component Designations and Values**

Part	Description	Part Number	Manufacturer
C1, C2	15 pF Chip Capacitors	ECUV1H150JCV	Panasonic
C3, C5	0.01 $\mu$ F Chip Capacitors	C0603C103J5RAC	Kemet
C4, C6	0.1 $\mu$ F Chip Capacitors	C0603C104J5RAC	Kemet
C7	6.8 pF Chip Capacitor	06035J6R8BS	AVX
C8	5.6 pF Chip Capacitor	06035J5R6BS	AVX
L1	15 nH Chip Inductor	1008CS-150XJB	Coilcraft
R1	33 $\Omega$ , 1/10 W Chip Resistor	CRCW060333R0FKEA	Vishay
R2	0 $\Omega$ , 1/10 W Chip Resistor	CRCW06030000FKEA	Vishay

### 50 OHM APPLICATION CIRCUIT: 900 MHz

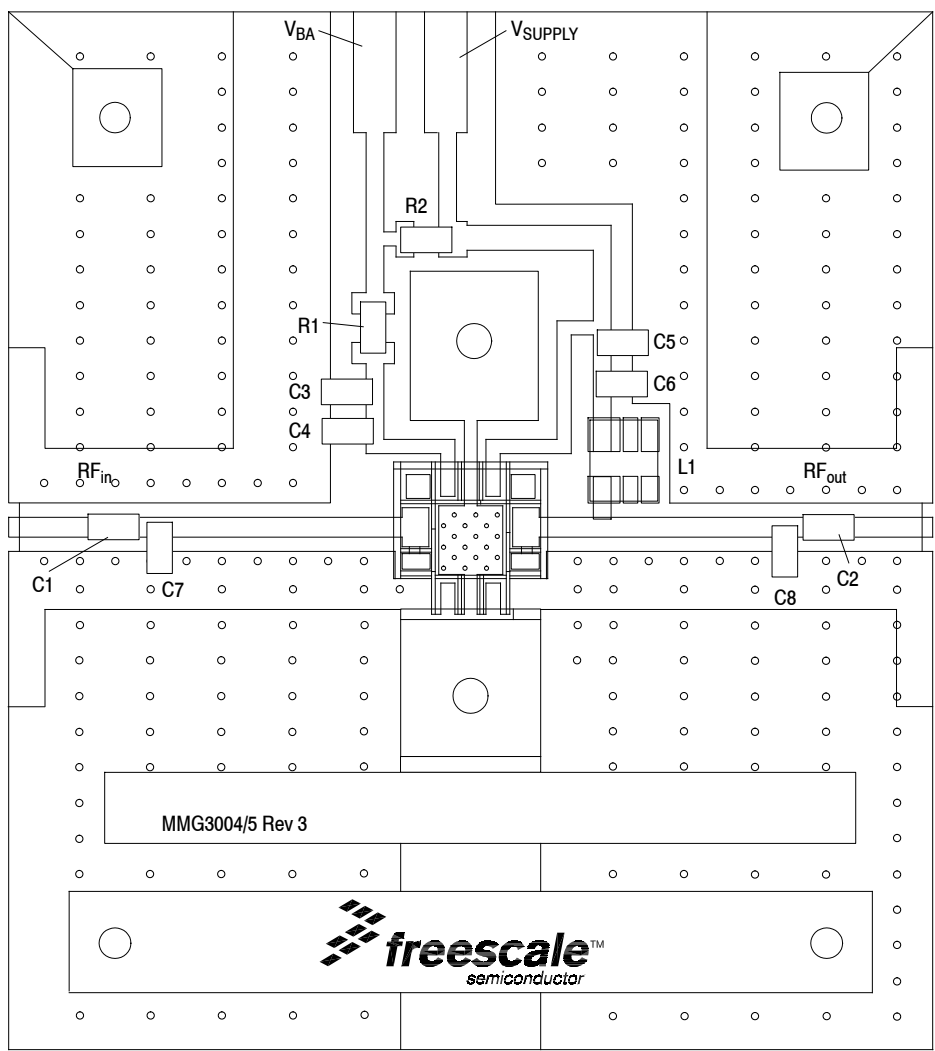
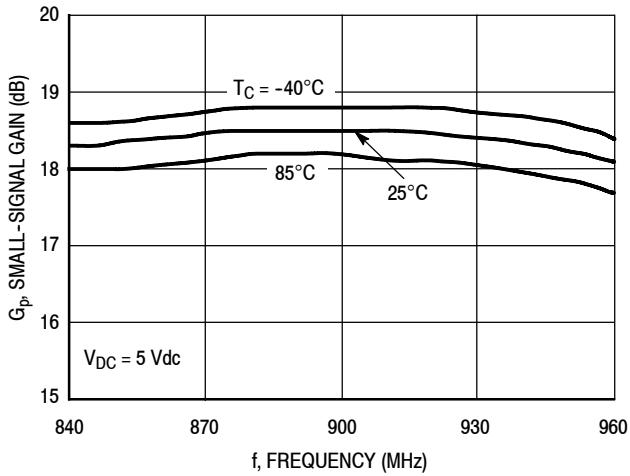
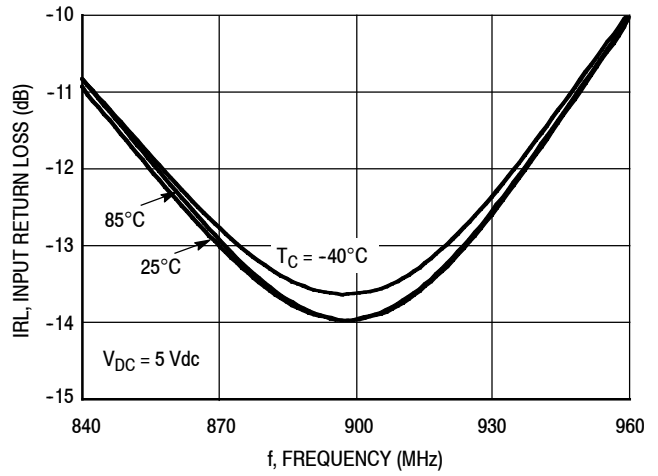


Figure 6. 50 Ohm Test Circuit Component Layout

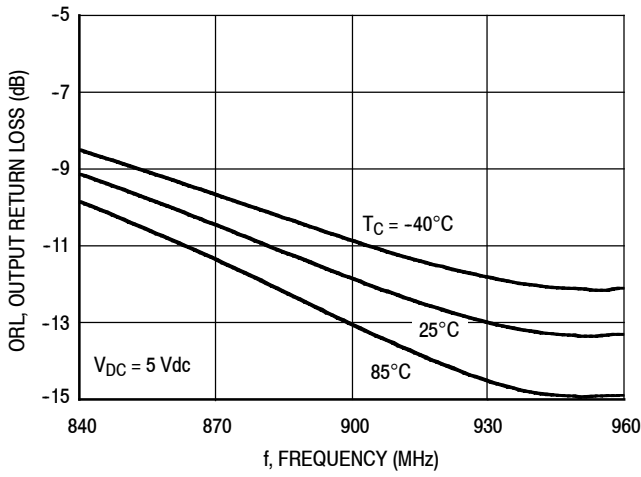
### 50 OHM TYPICAL CHARACTERISTICS: 900 MHz



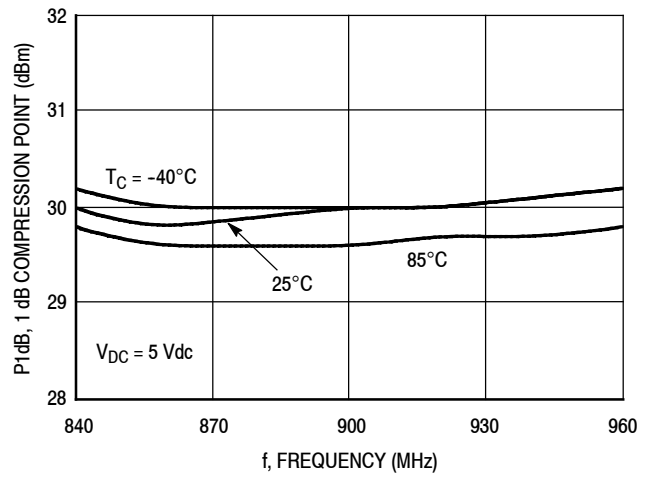
**Figure 7. Small-Signal Gain (S21) versus Frequency**



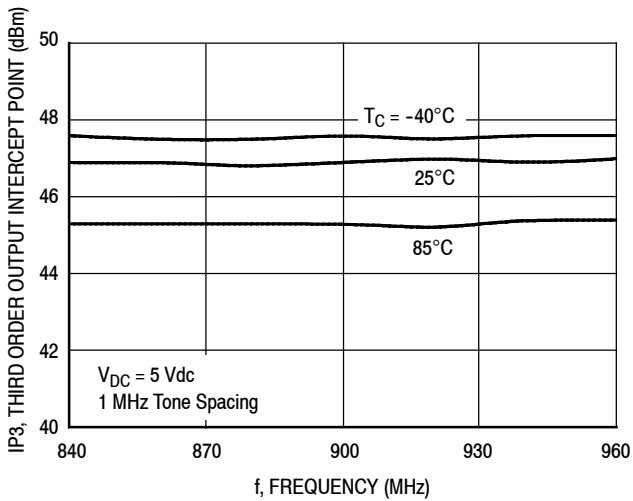
**Figure 8. Input Return Loss (S11) versus Frequency**



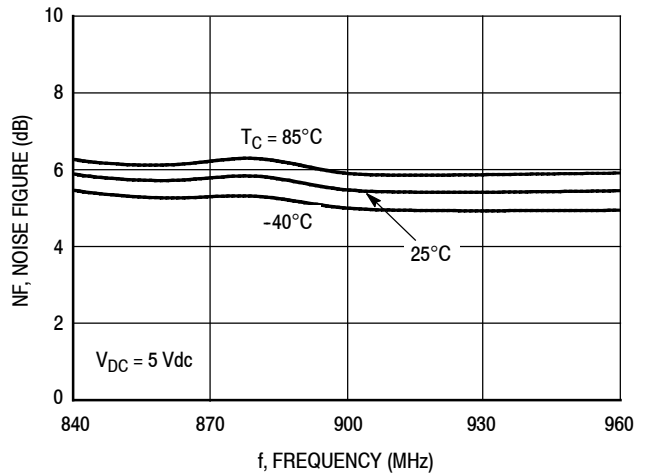
**Figure 9. Output Return Loss (S22) versus Frequency**



**Figure 10. P1dB versus Frequency**

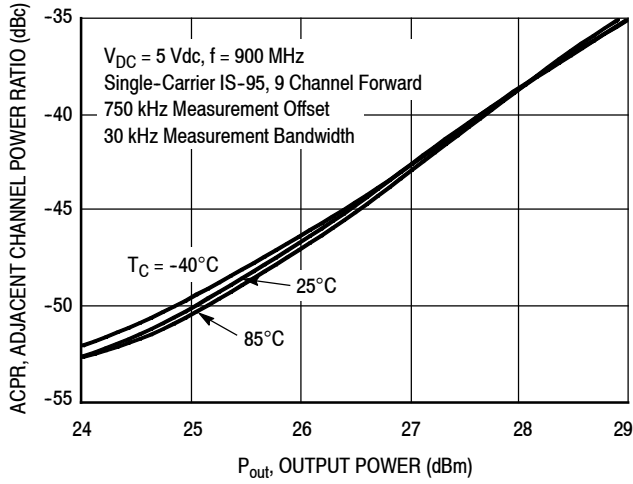


**Figure 11. Third Order Output Intercept Point versus Frequency**

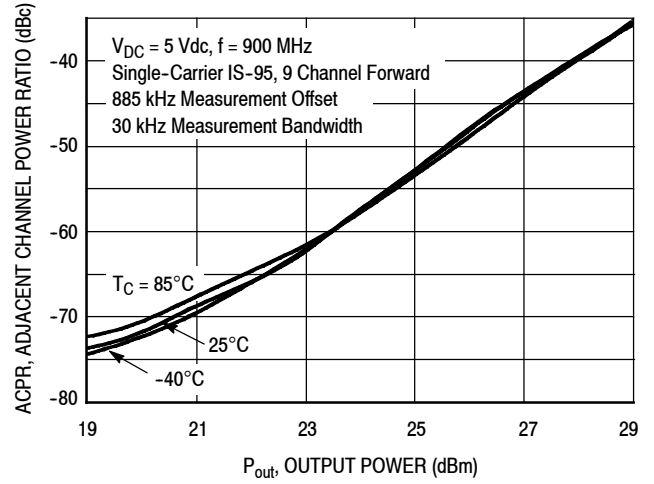


**Figure 12. Noise Figure versus Frequency**

### 50 OHM TYPICAL CHARACTERISTICS: 900 MHz

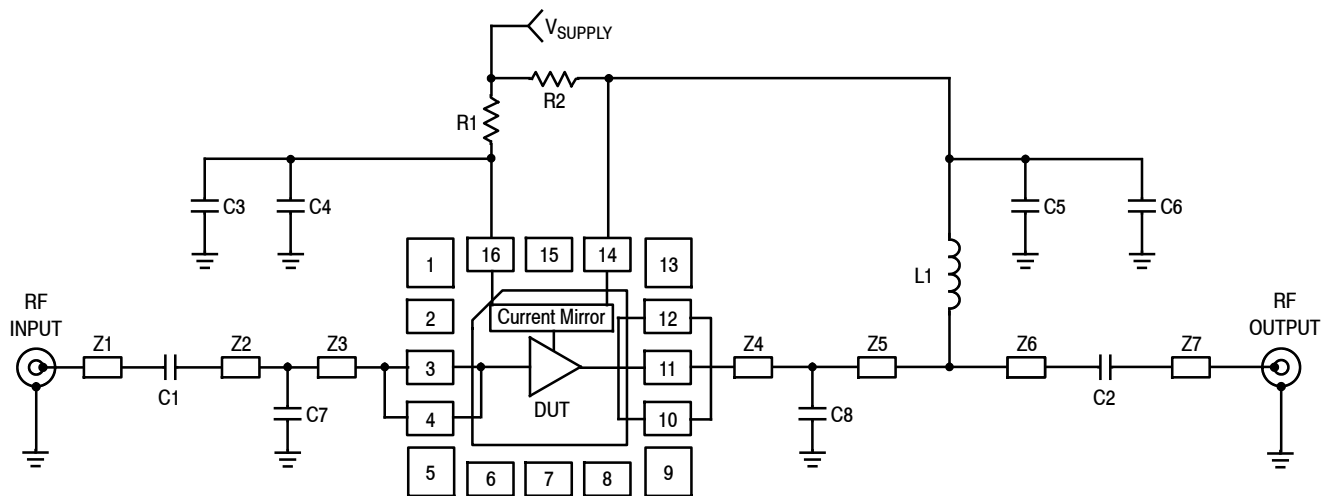


**Figure 13. IS-95 Adjacent Channel Power Ratio versus Output Power**



**Figure 14. IS-95 Adjacent Channel Power Ratio versus Output Power**

## 50 OHM APPLICATION CIRCUIT: 1800-2200 MHz



Z1, Z7	0.140" x 0.028" Microstrip	Z5	0.075" x 0.028" Microstrip
Z2	0.269" x 0.028" Microstrip	Z6	0.280" x 0.028" Microstrip
Z3	0.130" x 0.028" Microstrip	PCB	Isola FR408, 0.014", $\epsilon_r = 3.7$
Z4	0.044" x 0.028" Microstrip		

**Figure 15. 50 Ohm Test Circuit Schematic**

**Table 9. 50 Ohm Test Circuit Component Designations and Values**

Part	Description	Part Number	Manufacturer
C1	15 pF Chip Capacitor	ECUV1H150JCV	Panasonic
C2	1.8 pF Chip Capacitor	06035J1R8BS	AVX
C3, C5	0.01 $\mu$ F Chip Capacitors	C0603C103J5RAC	Kemet
C4, C6	0.1 $\mu$ F Chip Capacitors	C0603C104J5RAC	Kemet
C7	2.7 pF Chip Capacitor	06035J2R7BS	AVX
C8	1.2 pF Chip Capacitor	06035J1R2BS	AVX
L1	15 nH Chip Inductor	1008CS-150XJB	Coilcraft
R1	33 $\Omega$ , 1/10 W Chip Resistor	CRCW060333R0FKEA	Vishay
R2	0 $\Omega$ , 1/10 W Chip Resistor	CRCW06030000FKEA	Vishay



### 50 OHM APPLICATION CIRCUIT: 1800-2200 MHz

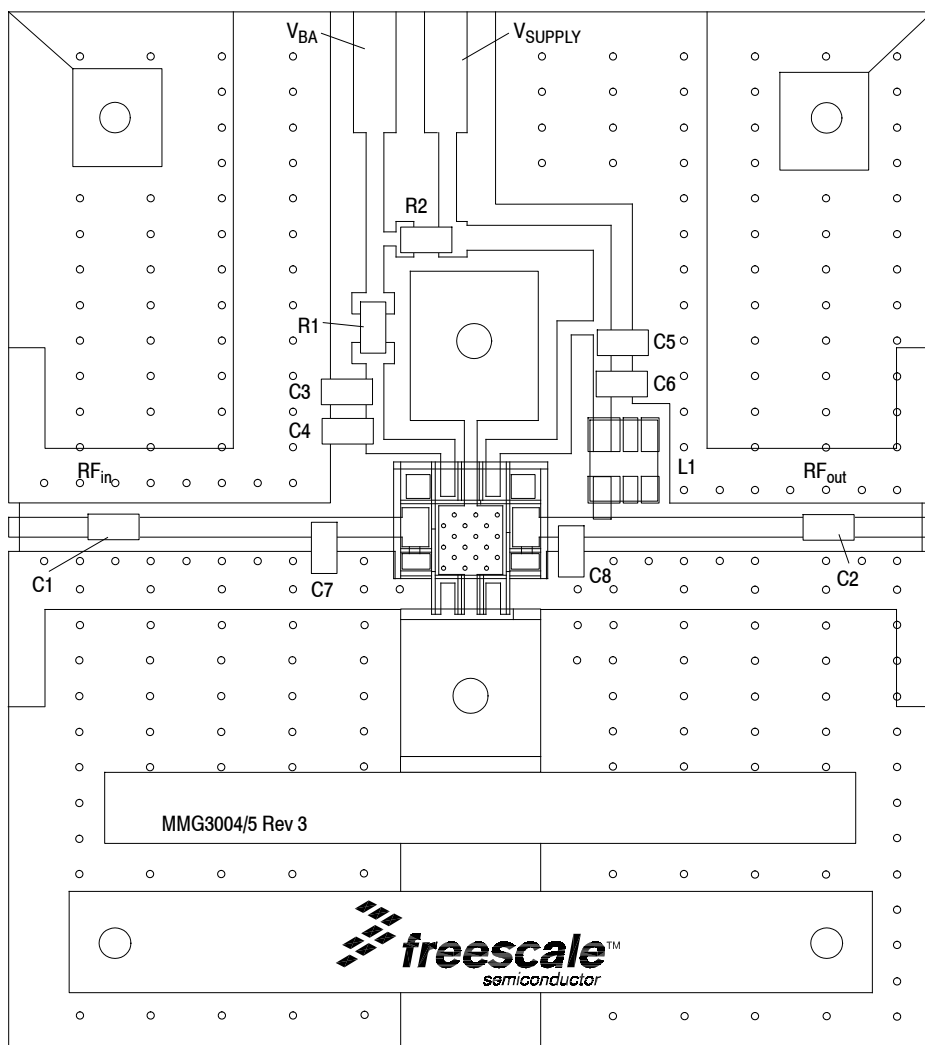
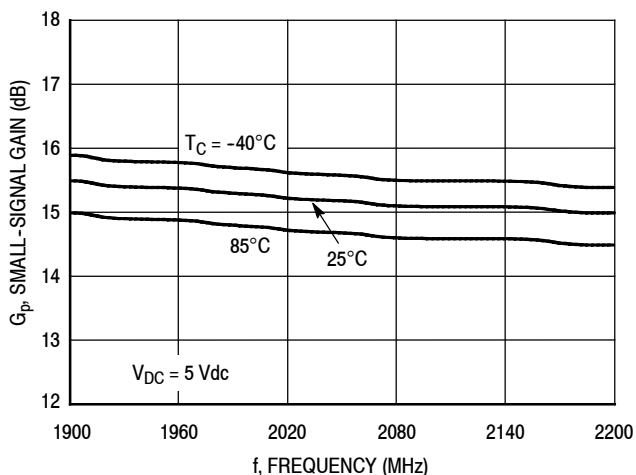
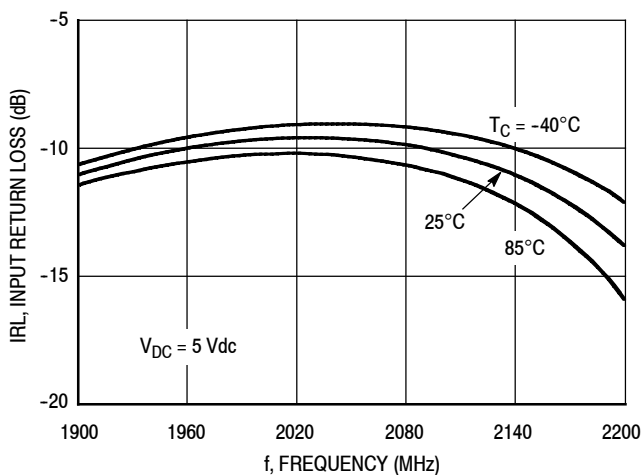


Figure 16. 50 Ohm Test Circuit Component Layout

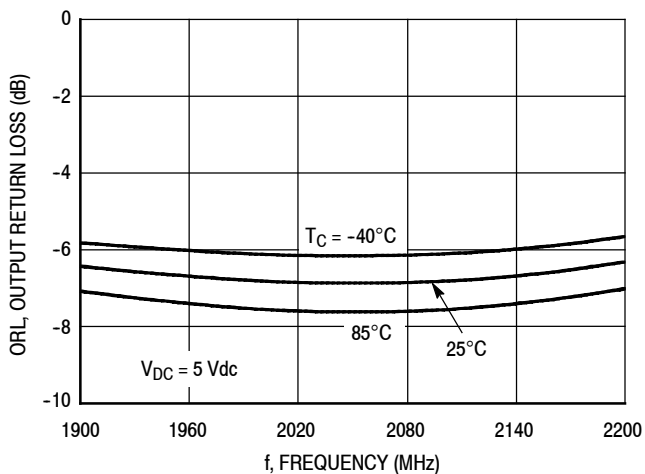
### 50 OHM TYPICAL CHARACTERISTICS: 1800-2200 MHz



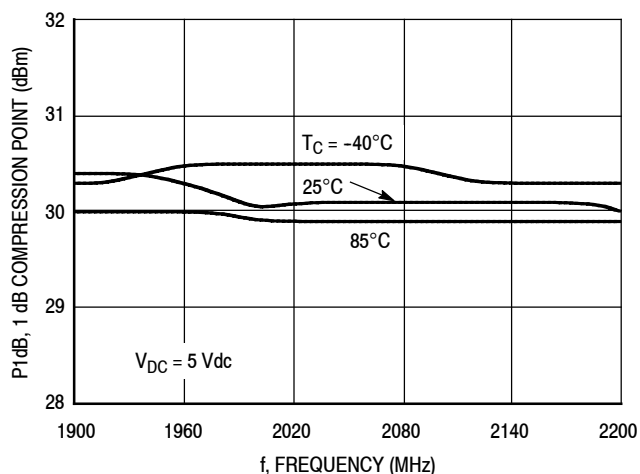
**Figure 17. Small-Signal Gain (S21) versus Frequency**



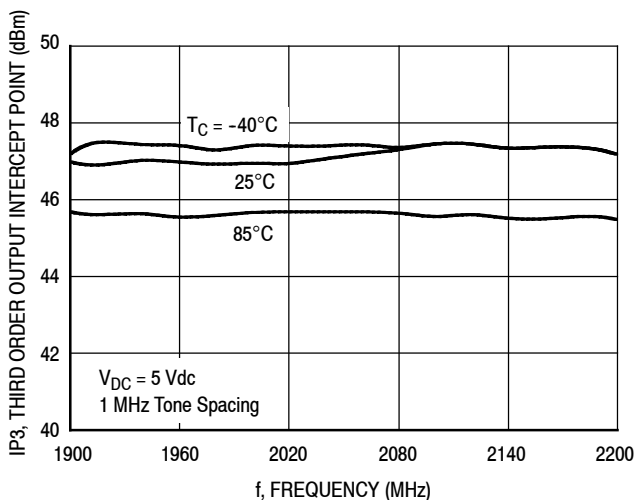
**Figure 18. Input Return Loss (S11) versus Frequency**



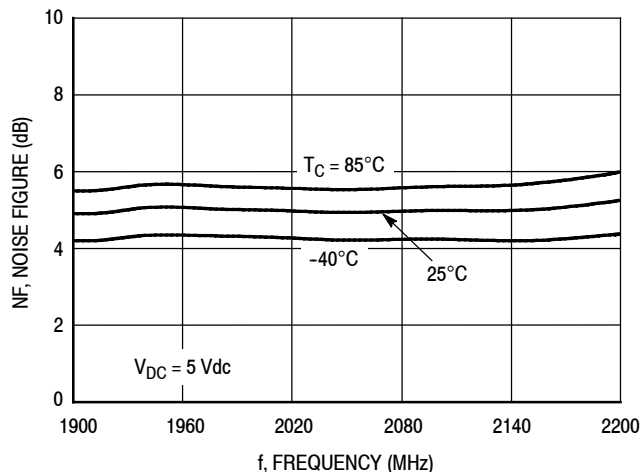
**Figure 19. Output Return Loss (S22) versus Frequency**



**Figure 20. P1dB versus Frequency**

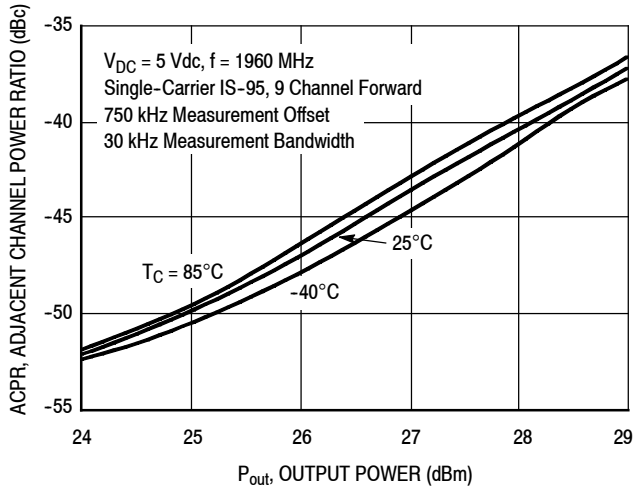


**Figure 21. Third Order Output Intercept Point versus Frequency**

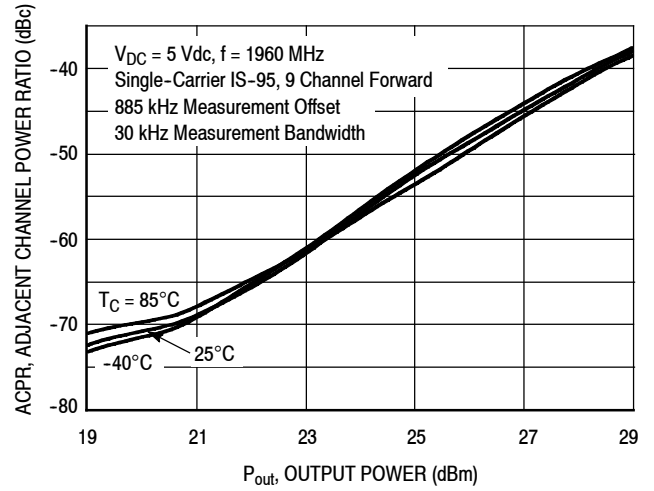


**Figure 22. Noise Figure versus Frequency**

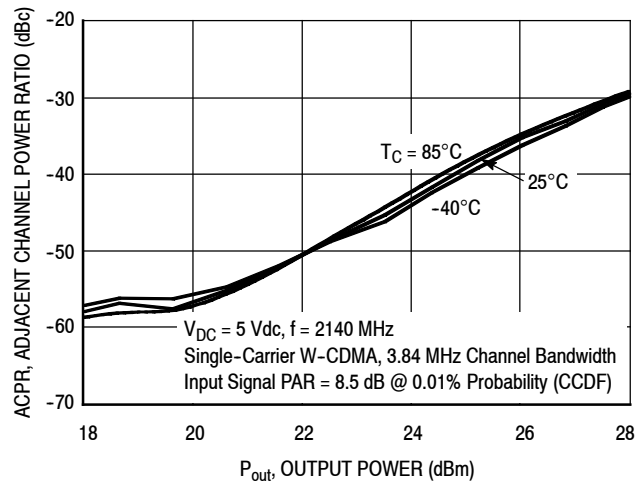
### 50 OHM TYPICAL CHARACTERISTICS: 1800-2200 MHz



**Figure 23. IS-95 Adjacent Channel Power Ratio versus Output Power**



**Figure 24. IS-95 Adjacent Channel Power Ratio versus Output Power**



**Figure 25. Single-Carrier W-CDMA Adjacent Channel Power Ratio versus Output Power**

## 50 OHM TYPICAL CHARACTERISTICS

**Table 10. Common Emitter S-Parameters** ( $V_{DC} = 5 \text{ Vdc}$ ,  $T_A = 25^\circ\text{C}$ , 50 Ohm System)

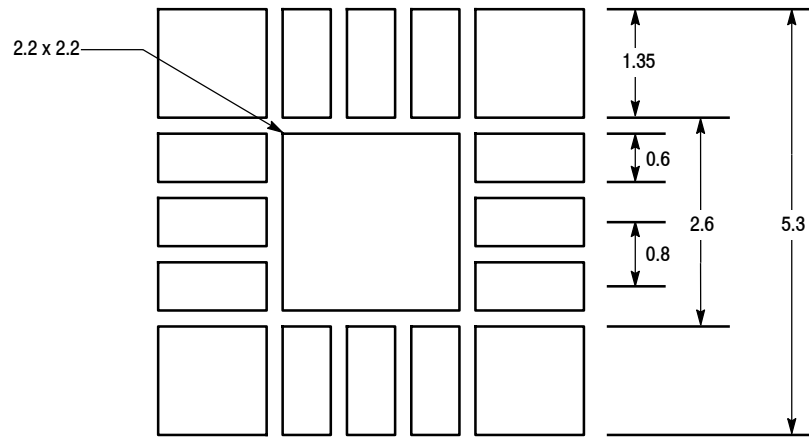
f MHz	S <sub>11</sub>		S <sub>21</sub>		S <sub>12</sub>		S <sub>22</sub>	
	S <sub>11</sub>	∠ φ	S <sub>21</sub>	∠ φ	S <sub>12</sub>	∠ φ	S <sub>22</sub>	∠ φ
250	0.70575	-173.81	5.06022	143.91	0.00976	-49.75	0.84913	174.65
300	0.73140	-174.91	4.79122	137.40	0.00866	-46.60	0.84273	173.16
350	0.75442	-176.26	4.52885	131.51	0.00773	-43.76	0.83759	172.12
400	0.77553	-177.67	4.27831	126.11	0.00689	-40.58	0.83409	171.28
450	0.79364	-179.04	4.03762	121.18	0.00618	-36.61	0.83042	170.63
500	0.80933	179.58	3.82617	116.75	0.00565	-31.68	0.83214	170.43
550	0.82301	178.27	3.62033	112.46	0.00523	-26.34	0.83079	169.99
600	0.83429	177.07	3.43310	108.55	0.00494	-20.59	0.82956	169.83
650	0.84357	175.98	3.26377	104.82	0.00478	-15.13	0.82812	169.78
700	0.85132	174.99	3.10735	101.29	0.00468	-10.28	0.82590	169.86
750	0.85696	174.16	2.96322	97.96	0.00459	-5.76	0.82489	170.15
800	0.86176	173.35	2.82568	94.86	0.00454	-1.51	0.82589	170.57
850	0.86572	172.60	2.70160	92.31	0.00452	3.52	0.82783	171.07
900	0.86813	171.85	2.60468	90.11	0.00455	7.99	0.83010	171.50
950	0.86945	171.15	2.53732	88.04	0.00475	12.64	0.83192	172.00
1000	0.86974	170.42	2.48944	85.86	0.00498	15.23	0.83202	172.45
1050	0.86842	169.66	2.45821	83.61	0.00517	16.96	0.83128	172.96
1100	0.86533	168.91	2.44429	81.27	0.00537	18.37	0.82923	173.50
1150	0.86095	168.14	2.44811	78.81	0.00562	19.48	0.82679	174.01
1200	0.85480	167.25	2.46595	76.18	0.00589	19.73	0.82313	174.63
1250	0.84684	166.25	2.49650	73.39	0.00614	19.47	0.81800	175.29
1300	0.83707	165.18	2.54318	70.39	0.00639	18.66	0.81154	176.08
1350	0.82469	164.00	2.60413	67.17	0.00664	17.14	0.80396	176.98
1400	0.80971	162.76	2.68767	63.69	0.00686	15.10	0.79812	177.98
1450	0.79087	161.42	2.79189	59.73	0.00707	12.45	0.79179	178.83
1500	0.76847	160.03	2.91082	55.24	0.00723	8.99	0.78258	179.68
1550	0.74126	158.60	3.04944	50.25	0.00735	4.62	0.77256	-179.28
1600	0.70933	157.30	3.20126	44.67	0.00737	-0.89	0.76200	-178.18
1650	0.67261	156.25	3.36356	38.42	0.00727	-7.59	0.75243	-176.93
1700	0.63202	155.73	3.53052	31.45	0.00702	-15.85	0.74435	-175.63
1750	0.59058	156.13	3.69596	23.72	0.00657	-25.99	0.73950	-174.33
1800	0.55219	157.76	3.84647	15.21	0.00592	-38.78	0.73766	-173.25
1850	0.53906	175.46	3.84639	5.98	0.00493	-55.47	0.74863	173.64
1900	0.55077	-178.72	3.76728	-3.57	0.00394	-78.20	0.76239	172.14
1950	0.58350	-174.08	3.61364	-13.31	0.00325	-110.26	0.77658	170.13
2000	0.63044	-171.29	3.40538	-22.98	0.00325	-147.37	0.78891	167.72
2050	0.68283	-170.32	3.15278	-32.28	0.00389	-177.72	0.79795	164.96
2100	0.73327	-170.78	2.87824	-41.07	0.00480	161.34	0.80422	162.03
2150	0.77875	-172.14	2.60183	-49.24	0.00576	146.52	0.80618	159.04
2200	0.81666	-174.06	2.33461	-56.78	0.00658	135.49	0.80601	156.02
2250	0.84807	-176.25	2.08577	-63.69	0.00728	126.95	0.80299	153.08
2300	0.87279	-178.55	1.85911	-70.01	0.00782	120.20	0.79865	150.21
2350	0.89261	179.07	1.65704	-75.82	0.00823	114.85	0.79341	147.45
2400	0.90758	176.70	1.47812	-81.19	0.00851	110.74	0.78715	144.80
2450	0.91984	174.31	1.32091	-86.22	0.00868	107.68	0.78067	142.25

(continued)

## 50 OHM TYPICAL CHARACTERISTICS

**Table 10. Common Emitter S-Parameters** ( $V_{DC} = 5 \text{ Vdc}$ ,  $T_A = 25^\circ\text{C}$ , 50 Ohm System) (continued)

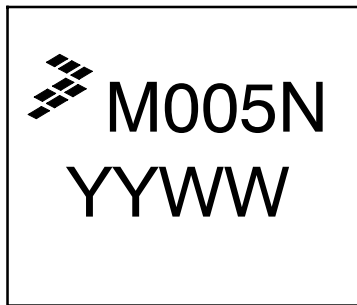
f MHz	S <sub>11</sub>		S <sub>21</sub>		S <sub>12</sub>		S <sub>22</sub>	
	S <sub>11</sub>	∠ φ	S <sub>21</sub>	∠ φ	S <sub>12</sub>	∠ φ	S <sub>22</sub>	∠ φ
2500	0.92917	171.99	1.18240	-90.93	0.00876	105.84	0.77298	139.76
2550	0.93606	169.65	1.06136	-95.41	0.00878	105.17	0.76528	137.41
2600	0.94249	167.38	0.95471	-99.69	0.00880	105.76	0.75557	135.15
2650	0.94659	165.17	0.86109	-103.83	0.00882	107.70	0.74569	132.95
2700	0.95002	163.00	0.77869	-107.89	0.00894	111.20	0.73387	130.86
2750	0.95243	160.86	0.70576	-111.91	0.00932	116.13	0.72034	128.82
2800	0.95418	158.70	0.64070	-115.96	0.01006	121.98	0.70405	126.97
2850	0.95534	156.67	0.58229	-120.08	0.01141	127.95	0.68401	125.22
2900	0.95570	154.64	0.52887	-124.40	0.01358	132.34	0.65990	123.77
2950	0.95565	152.68	0.47907	-128.91	0.01662	134.33	0.63014	122.76
3000	0.95487	150.86	0.43144	-133.65	0.02061	133.72	0.59605	122.51



NOTES:

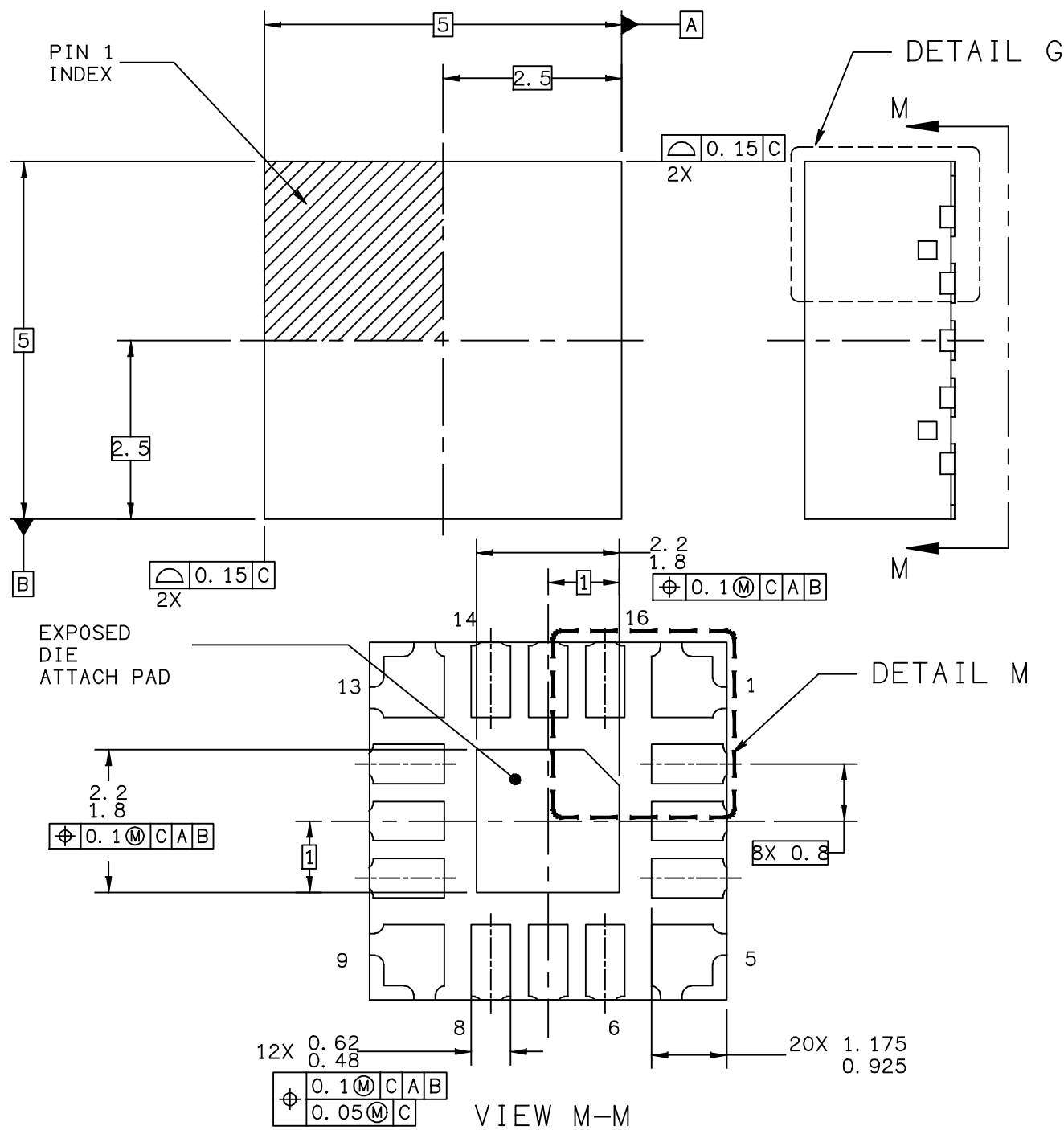
1. THERMAL AND RF GROUNDING CONSIDERATIONS SHOULD BE USED IN PCB LAYOUT DESIGN.
2. DEPENDING ON PCB DESIGN RULES, AS MANY VIAS AS POSSIBLE SHOULD BE PLACED ON THE BACKSIDE CENTER METAL GROUND LANDING PATTERN.
3. REFER TO FREESCALE APPLICATION NOTE AN2467 FOR ADDITIONAL PQFN PCB GUIDELINES.

**Figure 26. Recommended Mounting Configuration**

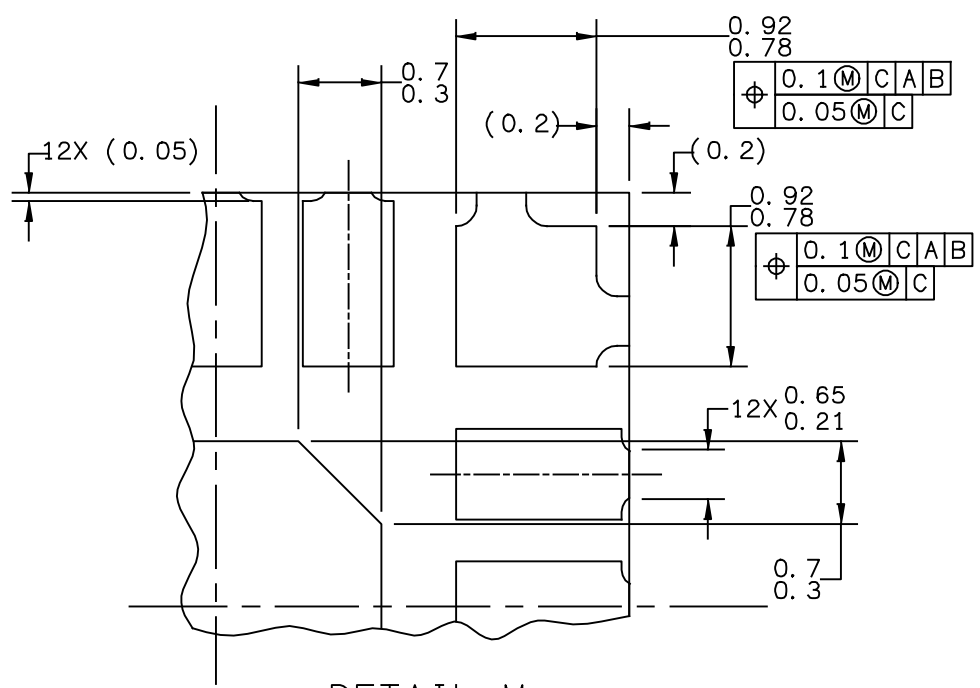


**Figure 27. Product Marking**

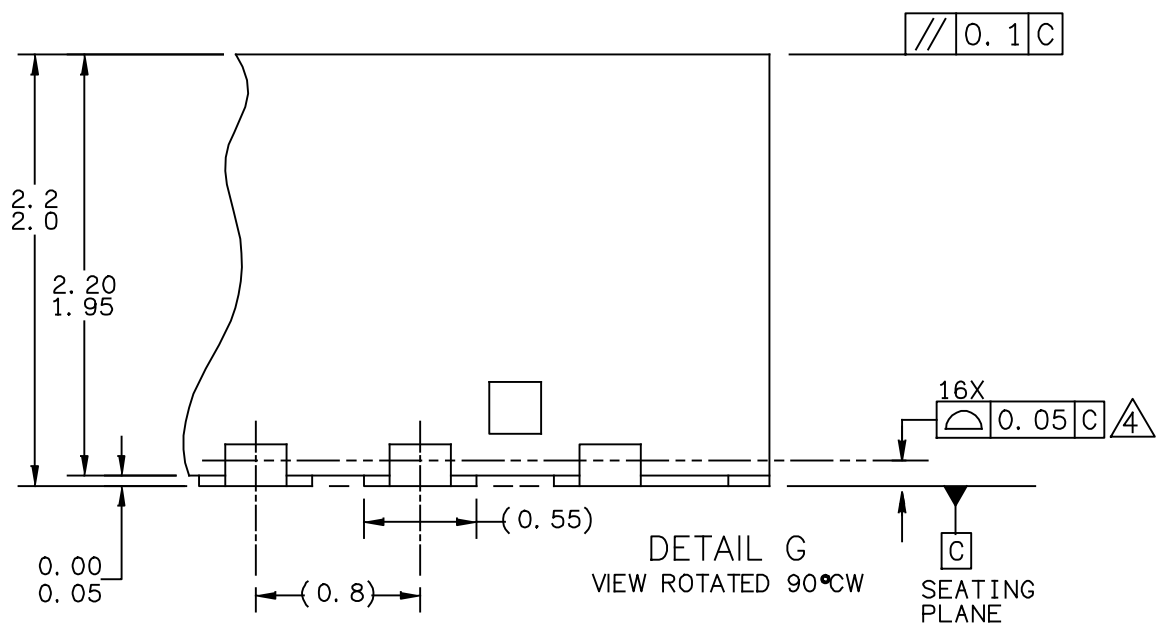
### PACKAGE DIMENSIONS



© FREESCALE SEMICONDUCTOR, INC. ALL RIGHTS RESERVED.	MECHANICAL OUTLINE	PRINT VERSION NOT TO SCALE	
TITLE:THERMALLY ENHANCED POWER QUAD FLAT NON-LEADED PACKAGE (PQFN) 16 TERMINAL, 0.8 PITCH (5X5X2.1) CASE OUTLINE	DOCUMENT NO: 98ARL10575D		REV: D
	CASE NUMBER: 1543-04		23 DEC 2008
	STANDARD: JEDEC M0-251		



DETAIL M  
CORNER CONFIGURATION




DETAIL G  
VIEW ROTATED 90°CW  
SEATING PLANE

© FREESCALE SEMICONDUCTOR, INC. ALL RIGHTS RESERVED.	MECHANICAL OUTLINE	PRINT VERSION NOT TO SCALE	
TITLE:THERMALLY ENHANCED POWER QUAD FLAT NON-LEADED PACKAGE (PQFN) 16 TERMINAL, 0.8 PITCH (5X5X2.1) CASE OUTLINE	DOCUMENT NO: 98ARL10575D	REV: D	
	CASE NUMBER: 1543-04	23 DEC 2008	
	STANDARD: JEDEC MO-251		



NOTES:

1. ALL DIMENSIONS ARE IN MILLIMETERS.
2. DIMENSIONING AND TOLERANCING PER ASME Y14.5M-1994.
3. THE COMPLETE JEDEC DESIGNATOR FOR THIS PACKAGE IS: HF-PQFN.
4.  COPLANARITY APPLIES TO LEADS AND DIE ATTACH PAD.
5. MINIMUM METAL GAP SHOULD BE 0.25MM.

© FREESCALE SEMICONDUCTOR, INC. ALL RIGHTS RESERVED.	MECHANICAL OUTLINE	PRINT VERSION NOT TO SCALE	
TITLE:THERMALLY ENHANCED POWER QUAD FLAT NON-LEADED PACKAGE (PQFN) 16 TERMINAL, 0.8 PITCH (5X5X2.1) CASE OUTLINE	DOCUMENT NO: 98ARL10575D	REV: D	
	CASE NUMBER: 1543-04	23 DEC 2008	
	STANDARD: JEDEC MO-251		

## PRODUCT DOCUMENTATION, SOFTWARE AND TOOLS

Refer to the following resources to aid your design process.

### Application Notes

- AN1955: Thermal Measurement Methodology of RF Power Amplifiers
- AN3100: General Purpose Amplifier Biasing
- AN3778: PCB Layout Guidelines for PQFN/QFN Style Packages Requiring Thermal Vias for Heat Dissipation

### Software

- .s2p File

### Development Tools

- Printed Circuit Boards

For Software and Tools, do a Part Number search at <http://www.freescale.com>, and select the “Part Number” link. Go to Software & Tools on the part’s Product Summary page to download the respective tool.

## FAILURE ANALYSIS

At this time, because of the physical characteristics of the part, failure analysis is limited to electrical signature analysis. In cases where Freescale is contractually obligated to perform failure analysis (FA) services, full FA may be performed by third party vendors with moderate success. For updates contact your local Freescale Sales Office.

## REVISION HISTORY

The following table summarizes revisions to this document.

Revision	Date	Description
3	Mar. 2007	<ul style="list-style-type: none"> <li>• Replaced Case Outline 1543-02 with updated 1543-03, Issue C, pp. 1, 16-18</li> <li>• Added <math>V_{CC}</math> callout to Pin Connections 10, 11, and 12 in Fig. 1, Pin Connections, p. 3</li> <li>• Updated Part Numbers in Table 8, Component Designations and Values, 900 MHz, to RoHS compliant part numbers, p. 5</li> <li>• Corrected circuit board callouts, <math>V_p</math> to <math>V_{BA}</math> and <math>V_{CC}</math> to <math>V_{SUPPLY}</math>, Fig. 5, 50 Ohm Test Circuit Component Layout, 900 MHz, p. 6</li> <li>• Removed <math>I_{DC}</math> value due to its variability over temperature, Figs. 12-13, IS-95 Adjacent Channel Power Ratio versus Output Power, 900 MHz, p. 8</li> <li>• Updated Part Numbers in Table 9, Component Designations and Values, 1800-2200 MHz, to RoHS compliant part numbers, p. 9</li> <li>• Corrected circuit board callouts, <math>V_p</math> to <math>V_{BA}</math> and <math>V_{CC}</math> to <math>V_{SUPPLY}</math>, Fig. 15, 50 Ohm Test Circuit Component Layout, 1800-2200 MHz, p. 10</li> <li>• Removed <math>I_{DC}</math> value due to its variability over temperature, Figs. 22-23, IS-95 Adjacent Channel Power Ratio versus Output Power, 1800-2200 MHz, and Fig. 24, Single-Carrier W-CDMA Adjacent Channel Power Ratio versus Output Power, 1800-2200 MHz, p. 12</li> <li>• Added Product Documentation and Revision History, p. 19</li> </ul>
4	Feb. 2008	<ul style="list-style-type: none"> <li>• Removed Footnote 2, Continuous voltage and current applied to device, from Table 2, Maximum Ratings, p. 1</li> <li>• Changed Table 4, Electrical Characteristics Supply Current Min value from 455 mA to 420 mA, p. 2</li> <li>• Corrected S-Parameter table frequency column label to read “MHz” versus “GHz” and corrected frequency values from GHz to MHz, pp. 13, 14</li> </ul>
5	Apr. 2008	<ul style="list-style-type: none"> <li>• Corrected Tape and Reel information from 12 mm, 7-inch Reel to 16 mm, 13-inch Reel, p. 1</li> <li>• Corrected Fig. 24, Single-Carrier W-CDMA Adjacent Channel Power Ratio versus Output Power y-axis (ACPR) unit of measure to dBc, p. 12</li> </ul>
6	June 2009	<ul style="list-style-type: none"> <li>• Replaced Case Outline 1543-03, Issue C, with 1543-04, Issue D, pp. 1, 16-18. Corrected I/O dimension from 0.95-1.2 mm to 0.925-1.175 mm.</li> <li>• Corrected temperature at which <math>\Theta_{JC}</math> is measured from 25°C to 100°C, Thermal Characteristics table, p. 1</li> </ul>
7	May 2010	<ul style="list-style-type: none"> <li>• Added new Fig. 3, Third Order Output Intercept Point versus Output Power and Supply Current, p. 4</li> <li>• Added AN3778, PCB Layout Guidelines for PQFN/QFN Style Packages Requiring Thermal Vias for Heat Dissipation, Application Notes, p. 19</li> <li>• Added .s2p File availability to Product Software, p. 19</li> </ul>

## REVISION HISTORY (continued)

Revision	Date	Description
8	Jan. 2011	<ul style="list-style-type: none"> <li>• Corrected temperature at which Theta<sub>JC</sub> is measured from 25°C to 100°C and added “no RF applied” to Thermal Characteristics table to indicate that thermal characterization is performed under DC test with no RF signal applied, p. 1</li> <li>• Removed I<sub>DC</sub> bias callout from Table 10, Common Source S-Parameters heading as bias is not a controlled value, pp. 13-14</li> <li>• Added Printed Circuit Boards availability to Development Tools, p. 19</li> </ul>
9	Oct. 2014	<ul style="list-style-type: none"> <li>• Table 6, ESD Protection Characteristics, removed the word “Minimum” after the ESD class rating. ESD ratings are characterized during new product development but are not 100% tested during production. ESD ratings provided in the data sheet are intended to be used as a guideline when handling ESD sensitive devices, p. 2</li> <li>• Added Fig. 27, Product Marking, p. 14</li> <li>• Added Failure Analysis information, p. 18</li> </ul>

### ***How to Reach Us:***

**Home Page:**  
[freescale.com](http://freescale.com)

**Web Support:**  
[freescale.com/support](http://freescale.com/support)

Information in this document is provided solely to enable system and software implementers to use Freescale products. There are no express or implied copyright licenses granted hereunder to design or fabricate any integrated circuits based on the information in this document.

Freescale reserves the right to make changes without further notice to any products herein. Freescale makes no warranty, representation, or guarantee regarding the suitability of its products for any particular purpose, nor does Freescale assume any liability arising out of the application or use of any product or circuit, and specifically disclaims any and all liability, including without limitation consequential or incidental damages. "Typical" parameters that may be provided in Freescale data sheets and/or specifications can and do vary in different applications, and actual performance may vary over time. All operating parameters, including "typicals," must be validated for each customer application by customer's technical experts. Freescale does not convey any license under its patent rights nor the rights of others. Freescale sells products pursuant to standard terms and conditions of sale, which can be found at the following address: [freescale.com/SalesTermsandConditions](http://freescale.com/SalesTermsandConditions).

Freescale and the Freescale logo are trademarks of Freescale Semiconductor, Inc., Reg. U.S. Pat. & Tm. Off. All other product or service names are the property of their respective owners.

© 2005–2011, 2014 Freescale Semiconductor, Inc.