USB-6216 Specifications

2022-10-07

Contents

USB-6216 Specifications..... 3

USB-6216 Specifications

These specifications apply to the USB-6216 BNC, USB-6216 Mass Termination, and USB-6216 Spring Terminal.

Definitions

Warranted specifications describe the performance of a model under stated operating conditions and are covered by the model warranty.

Characteristics describe values that are relevant to the use of the model under stated operating conditions but are not covered by the model warranty.

- **Typical** specifications describe the performance met by a majority of models.
- **Nominal** specifications describe an attribute that is based on design, conformance testing, or supplemental testing.

Specifications are **Typical** unless otherwise noted.

Conditions

Specifications are valid at 25 °C unless otherwise noted.

Analog Input

Number of channels	8 differential or 16 single ended
ADC resolution	16 bits
DNL	No missing codes guaranteed

INL	Refer to the AI Absolute Accuracy section	
Sample rate		
Single channel maximum		400 kS/s
Multichannel maximum (aggregate)		400 kS/s
Minimum		0 S/s
Timing resolution	50 ns	
Timing accuracy	50 ppm of sample rate	
Input coupling	DC	
Input range	$\pm 0.2\text{ V}$, $\pm 1\text{ V}$, $\pm 5\text{ V}$, $\pm 10\text{ V}$	
Maximum working voltage for analog inputs (signal + common mode)	$\pm 10.4\text{ V}$ of AI GND	
CMRR (DC to 60 Hz)	100 dB	
Input impedance		
Device on		
AI+ to AI GND	$>10\text{ G}\Omega$ in parallel with 100 pF	
AI- to AI GND	$>10\text{ G}\Omega$ in parallel with 100 pF	
Device off		
AI+ to AI GND	1,200 Ω	

AI- to AI GND	1,200 Ω
Input bias current	± 100 pA
Crosstalk (at 100 kHz)	
Adjacent channels	-75 dB
Non-adjacent channels	-90 dB
Small signal bandwidth (-3 dB)	1.5 MHz
Input FIFO size	4,095 samples
Scan list memory	4,095 entries
Data transfers	USB Signal Stream, programmed I/O
Overvoltage protection for all analog input and sense channels	
Device on	± 30 V for up to two AI pins
Device off	± 20 V for up to two AI pins
Input current during overvoltage condition	± 20 mA maximum/AI pin

Settling Time for Multichannel Measurements

Accuracy, full-scale step, all ranges	
± 90 ppm of step (± 6 LSB)	2.5 μ s convert interval
± 30 ppm of step (± 2 LSB)	3.5 μ s convert interval

±15 ppm of step (±1 LSB)

5.5 μs convert interval

Typical Performance Graphs

Figure 3. Settling Error versus Time for Different Source Impedances

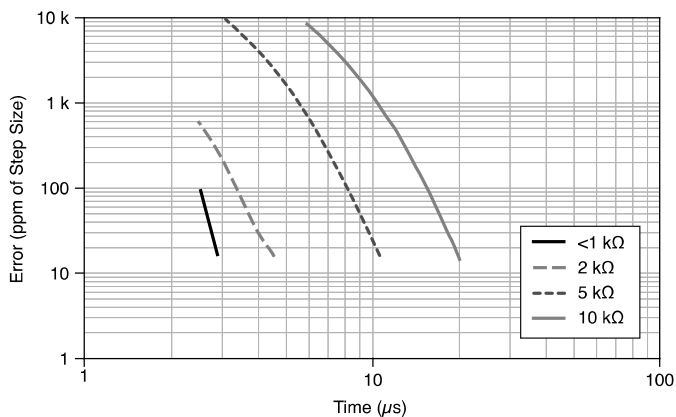
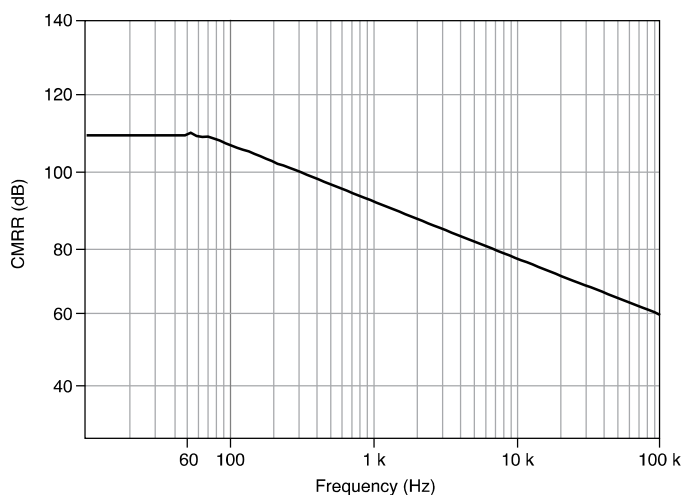

Figure 2. AI CMRR



AI Absolute Accuracy (Warranted)

Note Accuracies listed are valid for up to one year from the device external calibration.

Note The input/output channels of this device are not protected for electromagnetic interference due to functional reasons. As a result, this device may experience reduced measurement accuracy or other temporary performance degradation when connected cables are routed in an environment with radiated or conducted radio frequency electromagnetic interference. To ensure that this device functions within specifications in its operational electromagnetic environment and to limit radiated emissions, care should be taken in the selection, design, and installation of measurement probes and cables.

Nominal Range Positive Full Scale	Nominal Range Negative Full Scale	Residual Gain Error (ppm of Reading)	Residual Offset Error (ppm of Range)	Offset Tempco (ppm of Range/°C)	Random Noise, σ (μVrms)	Absolute Accuracy at Full Scale (μV)	Sensitivity (μV)
10	-10	75	20	34	295	2,710	118.0
5	-5	85	20	36	149	1,420	59.6
1	-1	95	25	49	32	310	12.8
0.2	-0.2	135	40	116	13	89	5.2

Table 1. AI Absolute Accuracy

Note Sensitivity is the smallest voltage change that can be detected. It is a function of noise.

Gain tempco	7.3 ppm/°C
Reference tempco	5 ppm/°C
INL error	76 ppm of range

AI Absolute Accuracy Equation

$$\text{AbsoluteAccuracy} = \text{Reading} \cdot (\text{GainError}) + \text{Range} \cdot (\text{OffsetError}) + \text{NoiseUncertainty}$$

- **GainError = ResidualAIGainError + GainTempco · (TempChangeFromLastInternalCal) + ReferenceTempco · (TempChangeFromLastExternalCal)**
- **OffsetError = ResidualAIOffsetError + OffsetTempco · (TempChangeFromLastInternalCal) + INLError**
- **NoiseUncertainty =**

$$\frac{\text{Random Noise} \cdot 3}{\sqrt{100}}$$
 for a coverage factor of 3 σ and averaging 100 points.

AI Absolute Accuracy Example

Absolute accuracy at full scale on the analog input channels is determined using the following assumptions:

- TempChangeFromLastExternalCal = 10 °C
- TempChangeFromLastInternalCal = 1 °C
- number_of_readings = 100
- CoverageFactor = 3 σ

For example, on the 10 V range, the absolute accuracy at full scale is as follows:

- GainError = 75 ppm + 7.3 ppm · 1 + 5 ppm · 10 = 132 ppm
- OffsetError = 20 ppm + 34 ppm · 1 + 76 ppm = 130 ppm
- NoiseUncertainty =

$$\frac{295 \mu\text{V} \cdot 3}{\sqrt{100}}$$
 = 88.5 μV
- AbsoluteAccuracy = 10 V · (GainError) + 10 V · (OffsetError) + NoiseUncertainty = 2,710 μV

Analog Output

Number of channels	2
--------------------	---

DAC resolution	16 bits
DNL	±1 LSB
Monotonicity	16 bit guaranteed
Maximum update rate	
1 channel	250 kS/s
2 channels	250 kS/s per channel
Timing accuracy	50 ppm of sample rate
Timing resolution	50 ns
Output range	±10 V
Output coupling	DC
Output impedance	0.2 Ω
Output current drive	±2 mA
Overdrive protection	±30 V
Overdrive current	2.4 mA
Power-on state	±20 mV
Power-on glitch	±1 V for 200 ms
Output FIFO size	8,191 samples shared among channels used

Data transfers	USB Signal Stream, programmed I/O
AO waveform modes	Non-periodic waveform, periodic waveform regeneration mode from onboard FIFO, periodic waveform regeneration from host buffer including dynamic update
Settling time, full-scale step, 15 ppm (1 LSB)	32 μ s
Slew rate	5 V/ μ s
Glitch energy	
Magnitude	100 mV
Duration	2.6 μ s

AO Absolute Accuracy (Warranted)

Absolute accuracy at full-scale numbers is valid immediately following internal calibration and assumes the device is operating within 10 °C of the last external calibration.

Note Accuracies listed are valid for up to one year from the device external calibration.

Note The input/output channels of this device are not protected for electromagnetic interference due to functional reasons. As a result, this device may experience reduced measurement accuracy or other temporary performance degradation when connected cables are routed in an environment with radiated or conducted radio frequency electromagnetic interference. To ensure that this device functions within specifications in its operational electromagnetic environment and to limit

radiated emissions, care should be taken in the selection, design, and installation of measurement probes and cables.

Nominal Range Positive Full Scale (V)	Nominal Range Negative Full Scale (V)	Residual Gain Error (ppm of Reading)	Gain Tempco (ppm/°C)	Residual Offset Error (ppm of Range)	Offset Tempco (ppm of Range/°C)	Absolute Accuracy at Full Scale (μV)
10	-10	90	11	60	12	3,512

Table 2. AO Absolute Accuracy

Reference tempco	5 ppm/°C
INL error	128 ppm of range

AO Absolute Accuracy Equation

$$\text{AbsoluteAccuracy} = \text{OutputValue} \cdot (\text{GainError}) + \text{Range} \cdot (\text{OffsetError})$$

- **GainError = ResidualGainError + GainTempco · (TempChangeFromLastInternalCal) + ReferenceTempco · (TempChangeFromLastExternalCal)**
- **OffsetError = ResidualOffsetError + AOffsetTempco · (TempChangeFromLastInternalCal) + INLError**

Digital I/O and PFI

Static Digital I/O Characteristics

Digital input or output

BNC/Mass Termination 24 total, 8 (P0.<0..7>), 16 (PFI <0..7>/P1.<0..7>,PFI <8..15>/P2.<0..7>)

Screw Terminal 32 total, 16 (P0.<0..15>), 16 (PFI <0..7>/P1.<0..7>,PFI <8..15>/P2.<0..7>)

Ground reference	D GND
Pull-down resistor	50 k Ω typical, 20 k Ω minimum
Input voltage protection	± 20 V on up to 8 pins ^[1]

PFI Functionality

Functionality	Static digital input, static digital output, timing input, timing output
Timing output sources	Many AI, AO, counter timing signals
Debounce filter settings	125 ns, 6.425 μ s, 2.56 ms, disable; high and low transitions; selectable per input

Maximum Operating Conditions

I_{OL} output low current	16 mA maximum
I_{OH} output high current	-16 mA maximum

Digital Input Characteristics

Level	Minimum	Maximum
V_{IL} input low voltage	0 V	0.8 V
V_{IH} input high voltage	2.2 V	5.25 V
I_{IL} input low current ($V_{in} = 0$ V)	-	-10 μ A
I_{IH} input high current ($V_{in} = 5$ V)	-	250 μ A
Positive-going threshold (V_{T+})	-	2.2 V

Level	Minimum	Maximum
Negative-going threshold (VT-)	0.8 V	-
Delta VT hysteresis (VT+ - VT-)	0.2 V	-

Digital Output Characteristics

Figure 3. PFI <0..15>/P0.<0..15>: I_{OH} versus V_{OH}

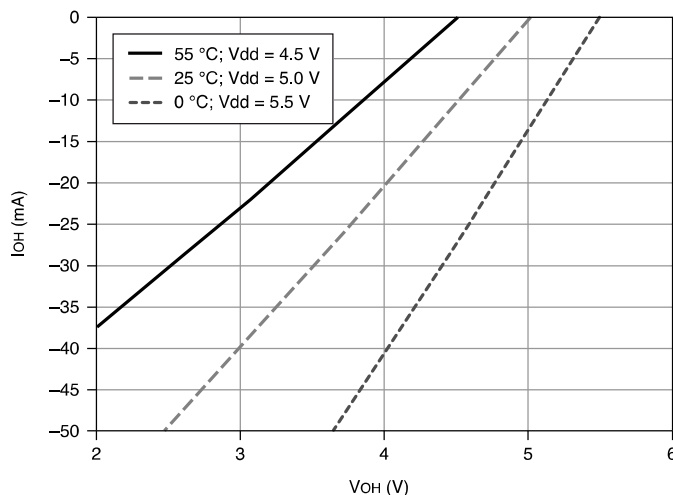
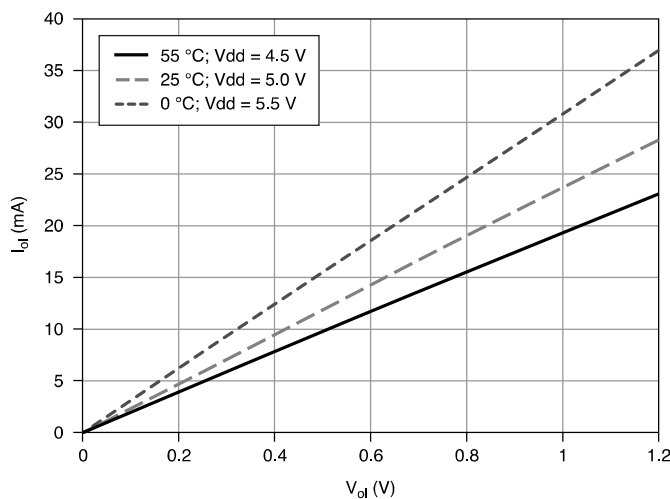

Figure 4. PFI <0..15>/P0.<0..15>: I_{OL} versus V_{OL}



General-Purpose Counters/Timers

Number of counter/timers	2
Resolution	32 bits
Counter measurements	Edge counting, pulse, semi-period, period, two-edge separation
Position measurements	X1, X2, X4 quadrature encoding with Channel Z reloading; two-pulse encoding
Output applications	Pulse, pulse train with dynamic updates, frequency division, equivalent time sampling
Internal base clocks	80 MHz, 20 MHz, 0.1 MHz
External base clock frequency	0 MHz to 20 MHz
Base clock accuracy	50 ppm
Inputs	Gate, Source, HW_Arm, Aux, A, B, Z, Up_Down
Routing options for inputs	PFI <0..15>, many internal signals
FIFO	1,023 samples
Data transfers	USB Signal Stream, programmed I/O

Frequency Generator

Number of channels	1
--------------------	---

Base clocks	10 MHz, 100 kHz
Divisors	1 to 16
Base clock accuracy	50 ppm

Output can be available on any output PFI terminal.

External Digital Triggers

Source	PFI <0..15>
Polarity	Software-selectable for most signals
Analog input function	Start Trigger, Reference Trigger, Pause Trigger, Sample Clock, Convert Clock, Sample Clock Timebase
Analog output function	Start Trigger, Pause Trigger, Sample Clock, Sample Clock Timebase
Counter/timer function	Gate, Source, HW_Arm, Aux, A, B, Z, Up_Down

Bus Interface

USB	USB 2.0 Hi-Speed or full-speed ^[2]
USB Signal Stream	4, can be used for analog input, analog output, counter/timer 0, counter/timer 1

Current Limits

+5 V terminal as output^[3]

Voltage	4.6 V to 5.2 V
Current (internally limited)	50 mA maximum, shared with digital outputs
+5 V terminal as input^[3]	
Voltage	4.75 V to 5.35 V
Current	350 mA maximum, self-resetting fuse

Caution Do **not** exceed 16 mA per DIO pin.

Protection	±10 V
------------	-------

Power Requirements

Input voltage on USB port	4.5 V to 5.25 V in configured state
Maximum inrush current	500 mA
No load typical current	320 mA at 4.5 V
Maximum load	
Typical current	400 mA at 4.5 V
Suspend current	260 µA typical

Physical Characteristics

Dimensions (includes connectors)

BNC	23.5 cm × 11.2 cm × 6.4 cm (9.25 in. × 4.40 in. × 2.50 in.)
Mass Termination	19.3 cm × 9.4 cm × 3.1 cm (7.61 in. × 3.68 in. × 1.20 in.)
Screw Terminal	16.9 cm × 9.4 cm × 3.1 cm (6.65 in. × 3.70 in. × 1.20 in.)
Weight	
BNC	950 g (33.5 oz)
Mass Termination	231 g (8.1 oz)
Screw Terminal	206 g (7.2 oz)
I/O connectors	
BNC	19 BNCs and 26 screw terminals
Mass Termination	1 68-pin SCSI
Screw Terminal	4 16-position combicon
Screw terminal wiring	16 AWG to 28 AWG
Torque for screw terminals	0.22 N · m to 0.25 N · m (2.0 lb · in. to 2.2 lb · in.)
USB connector	Series B receptacle

To clean the device, wipe with a dry towel.

Calibration

Recommended warm-up time	15 minutes
--------------------------	------------

Calibration interval	1 year
----------------------	--------

Environmental

Operating temperature	0 °C to 45 °C
Storage temperature	-20 °C to 70 °C
Humidity	10% RH to 90% RH, noncondensing
Maximum altitude	2,000 m
Pollution Degree	2

Indoor use only.

Safety Voltages

Connect only voltages that are below these limits.

Channel-to-earth ground^[4]	
Continuous	≤60 VDC Measurement Category I
Withstand	≤1,000 Vrms, verified by a 5 s dielectric withstand test
Analog channel-to-AI GND or AO GND (in the following figure, $ V_a - V_c $)	≤11 V, Measurement Category I
Digital channel-to-D GND (in the following figure, $ V_b - V_c $)	≤5.25 V, Measurement Category I

Measurement Category I is for measurements performed on circuits not directly connected to the electrical distribution system referred to as MAINS voltage. MAINS

is a hazardous live electrical supply system that powers equipment. This category is for measurements of voltages from specially protected secondary circuits. Such voltage measurements include signal levels, special equipment, limited-energy parts of equipment, circuits powered by regulated low-voltage sources, and electronics.

Caution This device is rated for Measurement Category I and the voltage across the isolation barrier is limited to no greater than 30 V_{rms}/60 VDC/42.4 V_{pk} continuous. Do not use for measurements within Measurement Categories CAT II, CAT III, or CAT IV.

Note Measurement Categories CAT I and CAT O (Other) are equivalent. These test and measurement circuits are not intended for direct connection to the MAINS building installations of Measurement Categories CAT II, CAT III, or CAT IV.

The following figure illustrates the safety voltages specifications.

Figure 5. USB-6216 Safety Voltages

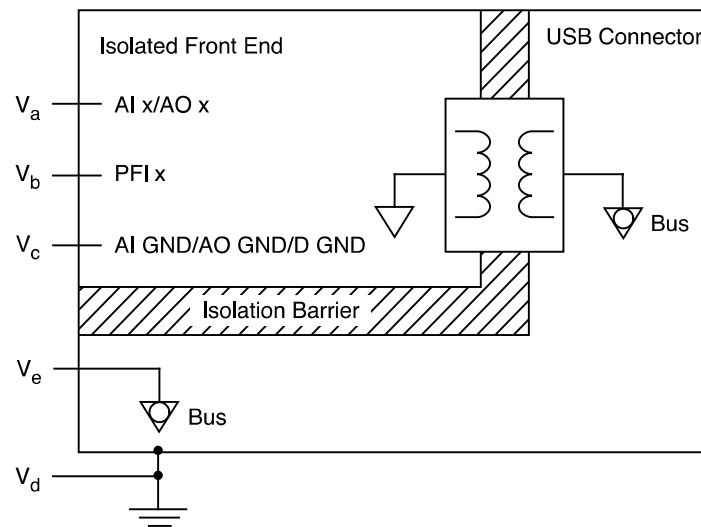

Safety Compliance Standards

This product is designed to meet the requirements of the following electrical equipment safety standards for measurement, control, and laboratory use:

- IEC 61010-1, EN 61010-1
- UL 61010-1, CSA C22.2 No. 61010-1

Note For safety certifications, refer to the product label or the [Product Certifications and Declarations](#) section.

Electromagnetic Compatibility

CE Compliance

- 2011/65/EU; Restriction of Hazardous Substances (RoHS)

Product Certifications and Declarations

Refer to the product Declaration of Conformity (DoC) for additional regulatory compliance information. To obtain product certifications and the DoC for NI products, visit ni.com/product-certifications, search by model number, and click the appropriate link.

Environmental Management

NI is committed to designing and manufacturing products in an environmentally responsible manner. NI recognizes that eliminating certain hazardous substances from our products is beneficial to the environment and to NI customers.

For additional environmental information, refer to the **Engineering a Healthy Planet** web page at ni.com/environment. This page contains the environmental regulations and directives with which NI complies, as well as other environmental information not included in this document.

EU and UK Customers

-  **Waste Electrical and Electronic Equipment (WEEE)**—At the end of the product life cycle, all NI products must be disposed of according to local laws and regulations. For more information about how to recycle NI products in your region, visit ni.com/environment/weee.

电子信息产品污染控制管理办法（中国 RoHS）

-  **中国 RoHS**— NI 符合中国电子信息产品中限制使用某些有害物质指令(RoHS)。关于 NI 中国 RoHS 合规性信息，请登录 ni.com/environment/rohs_china。(For information about China RoHS compliance, go to ni.com/environment/rohs_china.)

¹ Stresses beyond those listed under **Input voltage protection** may cause permanent damage to the device.

² If you are using an USB M Series device in full-speed mode, device performance will be lower and you will not be able to achieve maximum sample/update rates.

³ USB Screw Terminal/BNC devices have a self-resetting fuse that opens when current exceeds this specification. USB Mass Termination devices have a user-replaceable socketed fuse that opens when current exceeds this specification. Refer to the **NI USB-621x User Manual** for information about fuse replacement.

⁴ In the figure, $|V_a - V_d|$, $|V_b - V_d|$, and $|V_c - V_d|$.