

THIS DRAWING IS UNPUBLISHED.

RELEASED FOR PUBLICATION  
ALL RIGHTS RESERVED.

© COPYRIGHT - By -

LOC DIST

P	LTR	DESCRIPTION
A	RELEASED	
B1	REVISED	ECR-12-000186

REVISIONS  
変更  
DESCRIPTION

DATE	DMN	APVD
	OSMAR09	M.I
	SMAR2012	T.Z
		S.Y

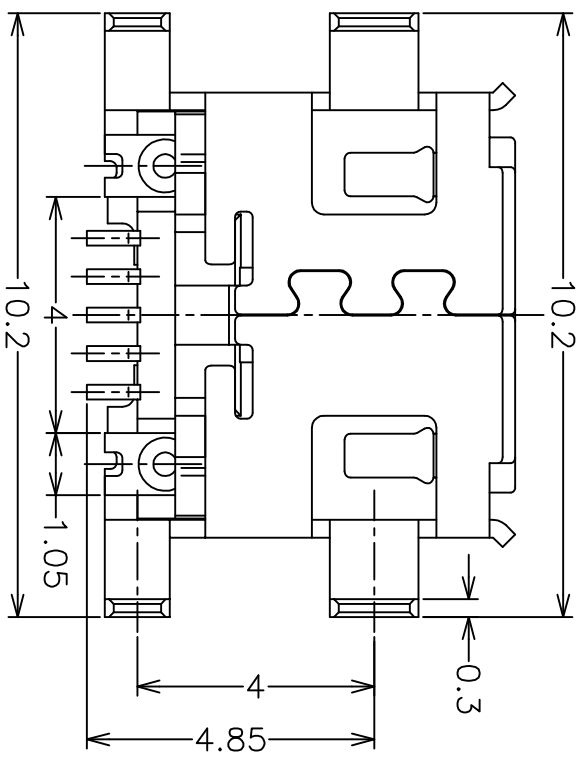
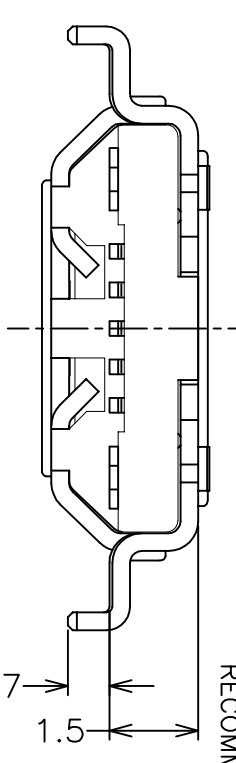
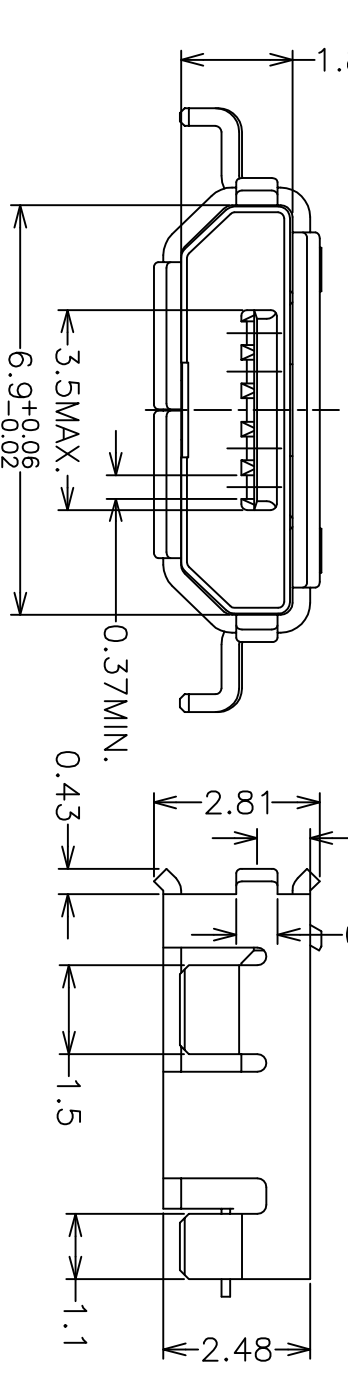
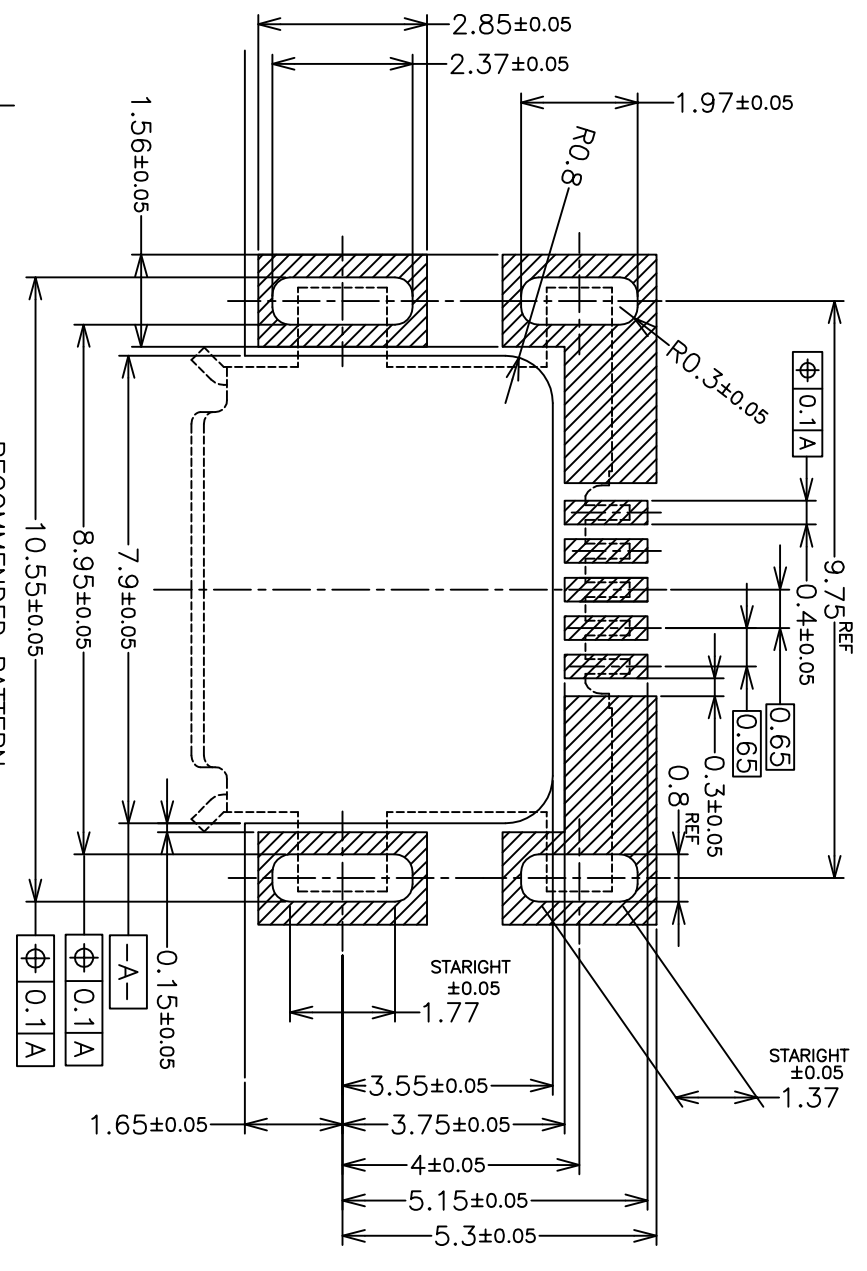
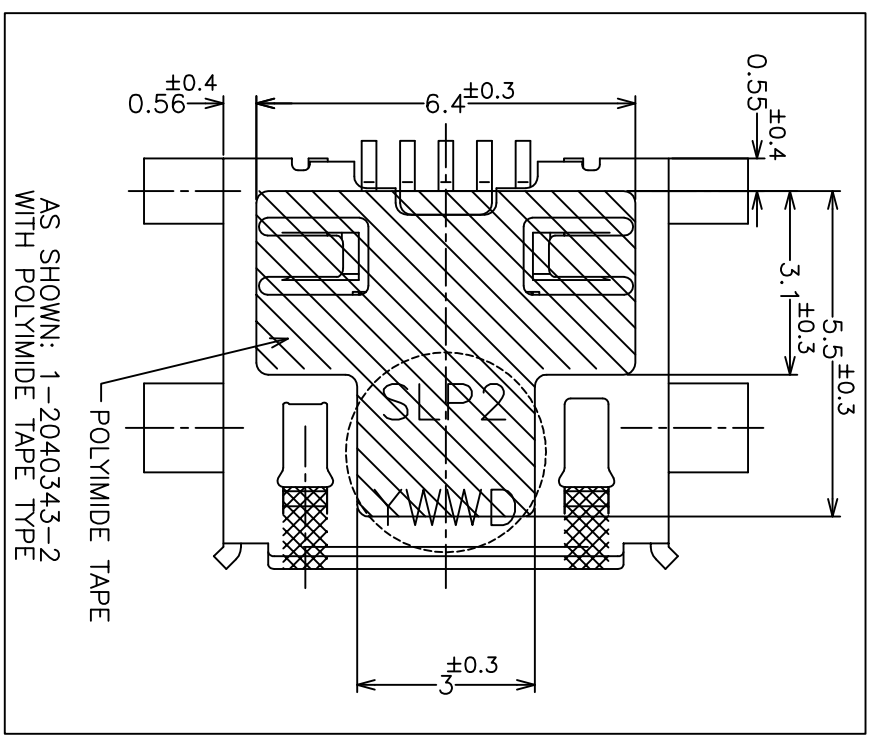
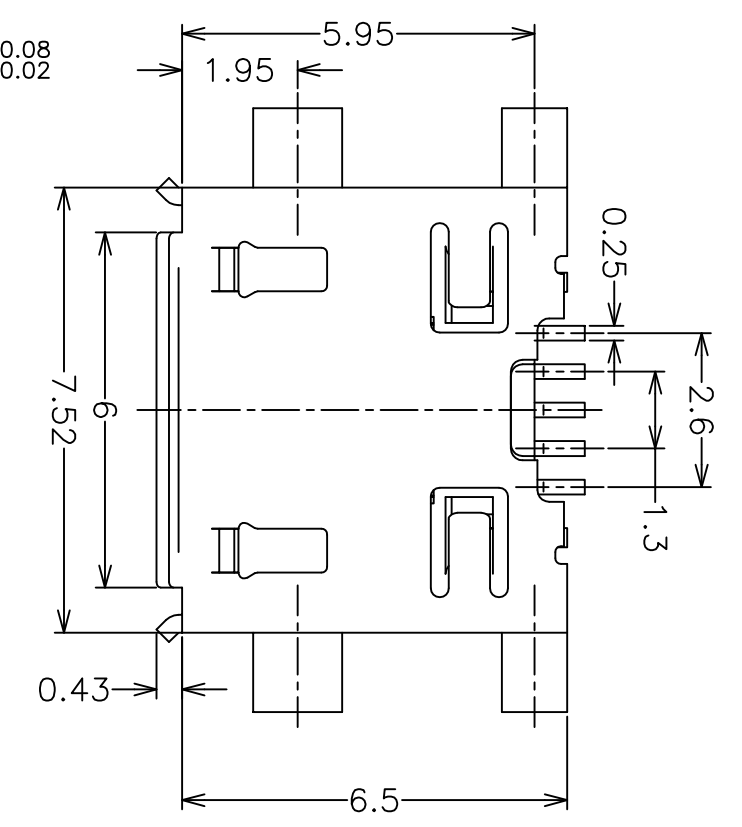

THIS DRAWING IS A CONTROLLED DOCUMENT.

DIMENSIONS:  
単位: 特  
mm

TOLERANCES UNLESS  
OTHERWISE SPECIFIED:  
一般公差

0	PLC	± 0.3
1	PLC	± 0.3
2	PLC	± 0.3
3	PLC	± 0.3
4	PLC ANGLES	± 0.3

FINISH  
仕上

MATERIAL  
材料

DMN M.IWASAKI

CHK A.KUBO

APVD Y.NAKAZAWA

PRODUCT SPEC

製品規格

APPLICATION SPEC

取付適用規格

WEIGHT

NAME	SIZE	CAGE CODE	DRAWING NO	RESTRICTED TO
KOAN HAO SKALGT5T75	WITH		A300779	
WITHOUT	WITH		2040343-2	
TAPE MATERIAL	LASER WELDING			
	PARTS NUMBER			

STE TE Connectivity

MICRO USB CONNECTOR  
MID-MOUNT DIP

CUSTOMER DRAWING

SCALE 8:1 SHEET 1 of 2 REV B1

THIS DRAWING IS UNPUBLISHED.

RELEASED FOR PUBLICATION

ALL RIGHTS RESERVED.

© COPYRIGHT - By -

LOG DIST

P LTR

SEE SHEET 1

REVISIONS

変更 DESCRIPTION

DATE

DMN

APVD

カバナーテープ部  
外周巻  
WIDE COVER TAPE AROUND  
OUT PERIPHERY 1 TURN

引き出し方向  
TOP OF REEL

剥離強度 0.2-0.7N MAX(300±10mm/min)  
PEELING STRENGTH  
剥離強度165~180°  
PEELING ANGLE

1000個/リール  
1000EA/REEL

HOLE  
8穴

空部 300mm程度 APPRDX  
製品装填部  
WITH PRODUCT CHARGE  
空部 600mm程度 APPRDX  
WITHOUT CHARGE  
WITH PRODUCT CHARGE  
WITHOUT CHARGE

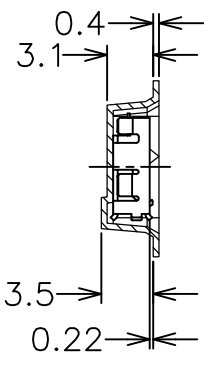
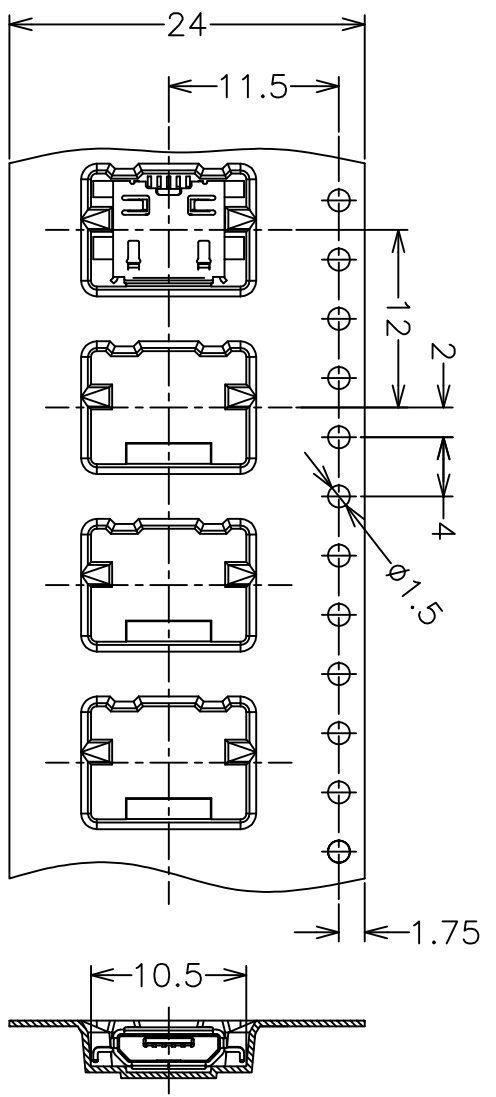
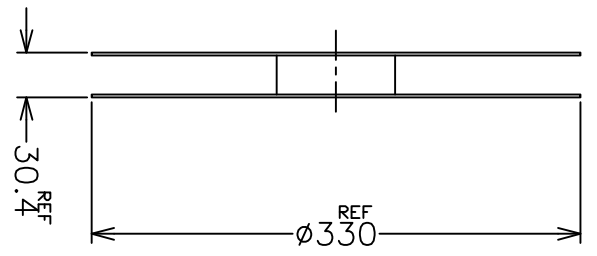

TOP OF REEL →

THIS DRAWING IS A CONTROLLED DOCUMENT.

DIMENSIONS: 単位: 特 mm

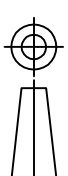

TOLERANCES UNLESS OTHERWISE SPECIFIED: 一般公差

- 0 PLC ±
- 1 PLC ±
- 2 PLC ±
- 3 PLC ±
- 4 PLC ±

MATERIAL 材料 FINISH 仕上



TE Connectivity

MICRO USB CONNECTOR  
MID-MOUNT DIP

NAME 名称  
SIZE 寸法  
CAGE CODE  
DRAWING NO 番号  
SCALE 尺度  
SHEET 2 of 2  
RESTRICTED TO  
REV B1

CUSTOMER DRAWING