

EVALUATION KIT
AVAILABLE

315MHz/433MHz ASK Superheterodyne Receiver with Extended Dynamic Range

General Description

The MAX1473 fully integrated low-power CMOS superheterodyne receiver is ideal for receiving amplitude-shift-keyed (ASK) data in the 300MHz to 450MHz frequency range. Its signal range is from -114dBm to 0dBm. With few external components and a low-current power-down mode, it is ideal for cost- and power-sensitive applications typical in the automotive and consumer markets. The chip consists of a low-noise amplifier (LNA), a fully differential image-rejection mixer, an on-chip phase-locked-loop (PLL) with integrated voltage-controlled oscillator (VCO), a 10.7MHz IF limiting amplifier stage with received-signal-strength indicator (RSSI), and analog baseband data-recovery circuitry. The MAX1473 also has a discrete one-step automatic gain control (AGC) that drops the LNA gain by 35dB when the RF input signal is greater than -57dBm.

The MAX1473 is available in 28-pin TSSOP and 32-pin thin QFN packages. Both versions are specified for the extended (-40°C to +85°C) temperature range.

Applications

Automotive Remote Keyless Entry Security Systems
Garage Door Openers Home Automation
Remote Controls Local Telemetry Systems
Wireless Sensors

Features

- ◆ Optimized for 315MHz or 433MHz ISM Band
- ◆ Operates from Single 3.3V or 5.0V Supplies
- ◆ High Dynamic Range with On-Chip AGC
- ◆ Selectable Image-Rejection Center Frequency
- ◆ Selectable x64 or x32 f_{LO}/f_{XTAL} Ratio
- ◆ Low 5.2mA Operating Supply Current
- ◆ < 2.5µA Low-Current Power-Down Mode for Efficient Power Cycling
- ◆ 250µs Startup Time
- ◆ Built-In 50dB RF Image Rejection
- ◆ Receive Sensitivity of -114dBm

Ordering Information

PART	TEMP RANGE	PIN-PACKAGE
MAX1473EUI+	-40°C to +85°C	28 TSSOP
MAX1473ETJ+	-40°C to +85°C	32 Thin QFN-EP*

+Denotes a lead(Pb)-free/RoHS-compliant package.

*EP = Exposed pad.

Functional Diagram and Typical Application Circuit appear at end of data sheet.

Pin Configurations

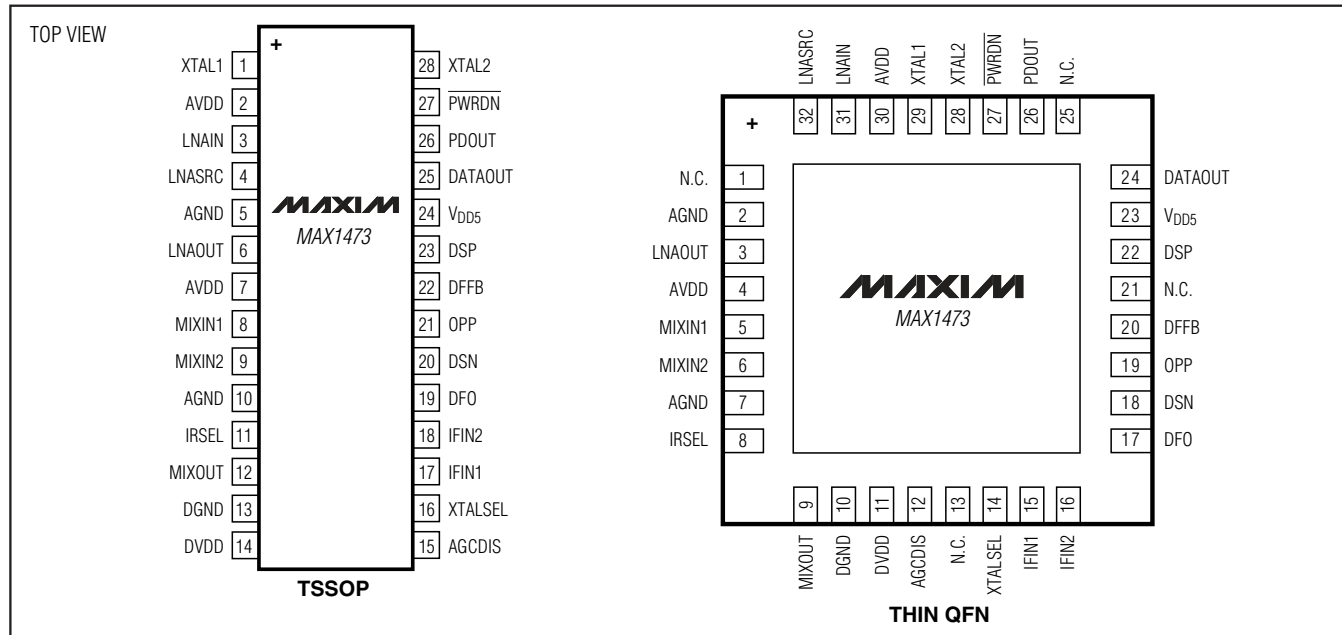

315MHz/433MHz ASK Superheterodyne Receiver with Extended Dynamic Range

ABSOLUTE MAXIMUM RATINGS

V _{DD5} to AGND	-0.3V to +6.0V	Continuous Power Dissipation (T _A = +70°C)
AVDD to AGND	-0.3V to +4.0V	28-Pin TSSOP (derate 12.8mW/°C above +70°C) .1025.6mW
DVDD to DGND	-0.3V to +4.0V	32-Pin Thin QFN (derate 21.3mW/°C
AGND to DGND	-0.1V to +0.1V	above +70°C).....
IRSEL, DATAOUT, XTALSEL, AGCDIS, PWRDN to AGND	-0.3V to (V _{DD5} + 0.3V)	1702.1mW
All Other Pins to AGND	-0.3V to (V _{DD} + 0.3V)	Operating Temperature Ranges
		MAX1473E_
		MAX1473E_
		Storage Temperature Range
		Lead Temperature (soldering 10s)
		Soldering Temperature (reflow)

Stresses beyond those listed under "Absolute Maximum Ratings" may cause permanent damage to the device. These are stress ratings only, and functional operation of the device at these or any other conditions beyond those indicated in the operational sections of the specifications is not implied. Exposure to absolute maximum rating conditions for extended periods may affect device reliability.

DC ELECTRICAL CHARACTERISTICS (3.3V OPERATION)

(Typical Application Circuit, V_{DD} = 3.0V to 3.6V, no RF signal applied, T_A = -40°C to +85°C, unless otherwise noted. Typical values are at V_{DD} = 3.3V and T_A = +25°C.) (Note 1)

PARAMETER	SYMBOL	CONDITIONS	MIN	TYP	MAX	UNITS
Supply Voltage	V _{DD}	3.3V nominal supply	3.0	3.3	3.6	V
Supply Current	I _{DD}	V _{PWRDN} = V _{DD}	f _{RF} = 315MHz	5.2	6.23	mA
			f _{RF} = 433MHz	5.8	6.88	
Shutdown Supply Current	I _{PWRDN}	V _{PWRDN} = 0V, V _{XTALSEL} = 0V	f _{RF} = 315MHz	1.6		μA
			f _{RF} = 433MHz	2.5	5.3	
Input Voltage Low	V _{IL}				0.4	V
Input Voltage High	V _{IH}		V _{DD} - 0.4			V
Input Logic Current High	I _{IH}			10		μA
Image Reject Select (Note 2)		f _{RF} = 433MHz, V _{IRSEL} = V _{DD}			V _{DD} - 0.4	V
		f _{RF} = 375MHz, V _{IRSEL} = V _{DD} /2	1.1		V _{DD} - 1.5	
		f _{RF} = 315MHz, V _{IRSEL} = 0V	0.4			
DATAOUT Voltage Output Low	V _{OL}	R _L = 5kΩ			0.4	V
DATAOUT Voltage Output High	V _{OH}			V _{DD} - 0.4		V

315MHz/433MHz ASK Superheterodyne Receiver with Extended Dynamic Range

MAX1473

DC ELECTRICAL CHARACTERISTICS (5.0V OPERATION)

(Typical Application Circuit, $V_{DD} = 4.5V$ to $5.5V$, no RF signal applied, $T_A = -40^\circ C$ to $+85^\circ C$, unless otherwise noted. Typical values are at $V_{DD} = 5.0V$ and $T_A = +25^\circ C$.) (Note 1)

PARAMETER	SYMBOL	CONDITIONS	MIN	TYP	MAX	UNITS
Supply Voltage	V_{DD}	5.0V nominal supply	4.5	5.0	5.5	V
Supply Current	I_{DD}	$\overline{VPWRDN} = V_{DD}$	$f_{RF} = 315MHz$	5.2	6.04	mA
			$f_{RF} = 433MHz$	5.7	6.76	
Shutdown Supply Current	\overline{IPWRDN}	$\overline{VPWRDN} = 0V$, $V_{XTALSEL} = 0V$	$f_{RF} = 315MHz$	2.3		μA
			$f_{RF} = 433MHz$	2.8	6.2	
Input Voltage Low	V_{IL}				0.4	V
Input Voltage High	V_{IH}		$V_{DD} - 0.4$			V
Input Logic Current High	I_{IH}			10		μA
Image Reject Select (Note 2)		$f_{RF} = 433MHz$, $V_{IRSEL} = V_{DD}$	$V_{DD} - 0.4$			V
		$f_{RF} = 375MHz$, $V_{IRSEL} = V_{DD}/2$	1.1	$V_{DD} - 1.5$		
		$f_{RF} = 315MHz$, $V_{IRSEL} = 0V$		0.4		
DATAOUT Voltage Output Low	V_{OL}	$R_L = 5k\Omega$			0.4	V
DATAOUT Voltage Output High	V_{OH}		$V_{DD} - 0.4$			V

AC ELECTRICAL CHARACTERISTICS

(Typical Application Circuit, $V_{DD} = 3.0V$ to $3.6V$, all RF inputs are referenced to 50Ω , $f_{RF} = 315MHz$, $T_A = -40^\circ C$ to $+85^\circ C$, unless otherwise noted. Typical values are at $V_{DD} = 3.3V$ and $T_A = +25^\circ C$.) (Note 1).

PARAMETER	SYMBOL	CONDITIONS	MIN	TYP	MAX	UNITS
GENERAL CHARACTERISTICS						
Startup Time	t_{ON}	Time for valid signal detection after $\overline{VPWRDN} = V_{OH}$		250		μs
Receiver Input Frequency	f_{RF}		300		450	MHz
Maximum Receiver Input Level	$PRFIN_MAX$	Modulation depth > 18dB		0		dBm
Sensitivity (Note 3)	$PRFIN_MIN$	Peak power level		-114		dBm
AGC Hysteresis		LNA gain from low to high		8		dB
				150		ms
LNA IN HIGH-GAIN MODE						
Power Gain				16		dB
Input Impedance (Note 4)	Z_{IN_LNA}	Normalized to 50Ω	$f_{RF} = 433MHz$	1 - j3.4		
			$f_{RF} = 375MHz$	1 - j3.9		
			$f_{RF} = 315MHz$	1 - j4.7		
1dB Compression Point	$P1dB_{LNA}$			-22		dBm
Input-Referred 3rd-Order Intercept	$IIP3_{LNA}$			-12		dBm

315MHz/433MHz ASK Superheterodyne Receiver with Extended Dynamic Range

AC ELECTRICAL CHARACTERISTICS (continued)

(Typical Application Circuit, $V_{DD} = 3.0V$ to $3.6V$, all RF inputs are referenced to 50Ω , $f_{RF} = 315MHz$, $T_A = -40^\circ C$ to $+85^\circ C$, unless otherwise noted. Typical values are at $V_{DD} = 3.3V$ and $T_A = +25^\circ C$.) (Note 1)

PARAMETER	SYMBOL	CONDITIONS	MIN	TYP	MAX	UNITS
LO Signal Feedthrough to Antenna				-80		dBm
Noise Figure	NFLNA			2		dB
LNA IN LOW-GAIN MODE						
Input Impedance (Note 4)	Z _{IN_LNA}	Normalized to 50Ω	f _{RF} = 433MHz	1 - j3.4		
			f _{RF} = 375MHz	1 - j3.9		
			f _{RF} = 315MHz	1 - j4.7		
1dB Compression Point	P1dB _{LNA}			-10		dBm
Input-Referred 3rd-Order Intercept	IIP3 _{LNA}			-7		dBm
LO Signal Feedthrough to Antenna				-80		dBm
Noise Figure	NFLNA			2		dB
Power Gain				0		dB
Voltage Gain Reduction		AGC enabled (depends on tank Q)		35		dB
MIXER						
Input-Referred 3rd-Order Intercept	IIP3 _{MIX}			-18		dBm
Output Impedance	Z _{OUT_MIX}			330		Ω
Noise Figure	NFMIX			16		dB
Image Rejection (not Including LNA Tank)			f _{RF} = 433MHz, V _{IRSEL} = V _{DD}	42		dB
			f _{RF} = 375MHz, V _{IRSEL} = V _{DD} /2	44		
			f _{RF} = 315MHz, V _{IRSEL} = 0V	44		
Conversion Gain		330Ω IF filter load		13		dB
INTERMEDIATE FREQUENCY (IF)						
Input Impedance	Z _{IN_IF}			330		Ω
Operating Frequency	f _{IF}	Bandpass response		10.7		MHz
3dB Bandwidth				20		MHz
RSSI Linearity				±0.5		dB
RSSI Dynamic Range				80		dB
RSSI Level		PRFIN < -120dBm		1.15		V
		PRFIN > 0dBm, AGC enabled		2.35		
RSSI Gain				14.2		mV/dB
AGC Threshold		LNA gain from low to high		1.45		V
		LNA gain from high to low		2.05		

315MHz/433MHz ASK Superheterodyne Receiver with Extended Dynamic Range

MAX1473

AC ELECTRICAL CHARACTERISTICS (continued)

(Typical Application Circuit, $V_{DD} = 3.0V$ to $3.6V$, all RF inputs are referenced to 50Ω , $f_{RF} = 315MHz$, $T_A = -40^\circ C$ to $+85^\circ C$, unless otherwise noted. Typical values are at $V_{DD} = 3.3V$ and $T_A = +25^\circ C$.) (Note 1)

PARAMETER	SYMBOL	CONDITIONS	MIN	TYP	MAX	UNITS
DATA FILTER						
Maximum Bandwidth	BW _{DF}			100		kHz
DATA SLICER						
Comparator Bandwidth	BW _{CMP}			100		kHz
Output High Voltage				V_{DD5}		V
Output Low Voltage				0		V
CRYSTAL OSCILLATOR						
Crystal Frequency (Note 5)	f_{XTAL}	$f_{RF} = 433MHz$	$V_{XTALSEL} = 0V$	6.6128		MHz
			$V_{XTALSEL} = V_{DD}$	13.2256		
		$f_{RF} = 315MHz$	$V_{XTALSEL} = 0V$	4.7547		MHz
			$V_{XTALSEL} = V_{DD}$	9.5094		
Crystal Tolerance				50		ppm
Input Capacitance		From each pin to ground		6.2		pF
Recommended Crystal Load Capacitance	C_{LOAD}			3		pF
Maximum Crystal Load Capacitance	C_{LOAD}			10		pF

Note 1: 100% tested at $T_A = +25^\circ C$. Guaranteed by design and characterization over temperature.

Note 2: IRSEL is internally set to 375MHz IR mode. It can be left open when the 375MHz image rejection setting is desired. A 1nF capacitor is recommended in noisy environments.

Note 3: BER = 2×10^{-3} , Manchester encoded, data rate = 4kbps, IF bandwidth = 280kHz.

Note 4: Input impedance is measured at the LNAIN pin. Note that the impedance includes the 15nH inductive degeneration connected from the LNA source to ground. The equivalent input circuit is 50Ω in series with 2.2pF.

Note 5: Crystal oscillator frequency for other RF carrier frequency within the 300MHz to 450MHz range is $(f_{RF} - 10.7MHz)/64$ for XTALSEL = 0V, and $(f_{RF} - 10.7MHz)/32$ for XTALSEL = V_{DD} .

315MHz/433MHz ASK Superheterodyne Receiver with Extended Dynamic Range

Typical Operating Characteristics

(Typical Application Circuit, $V_{DD} = 3.3V$, $f_{RF} = 315MHz$, $T_A = +25^\circ C$, unless otherwise noted.)

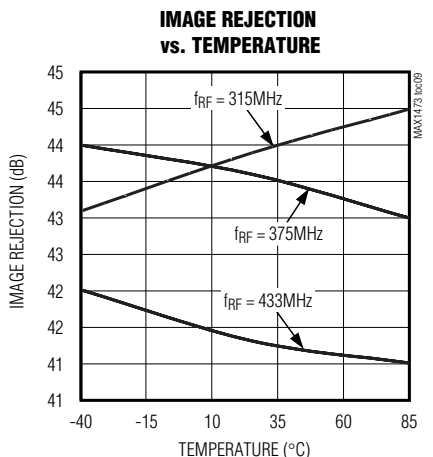
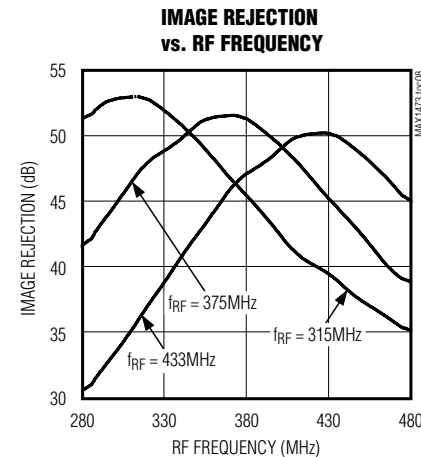
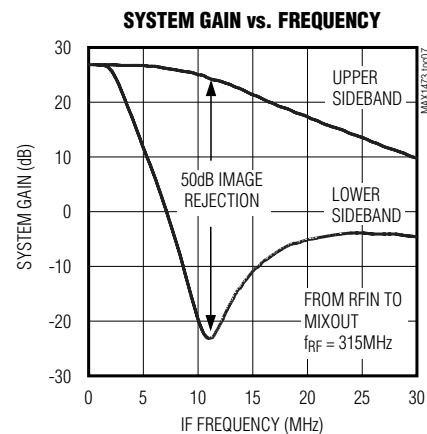
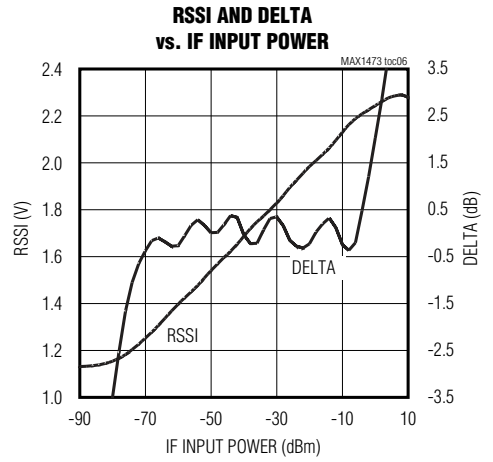
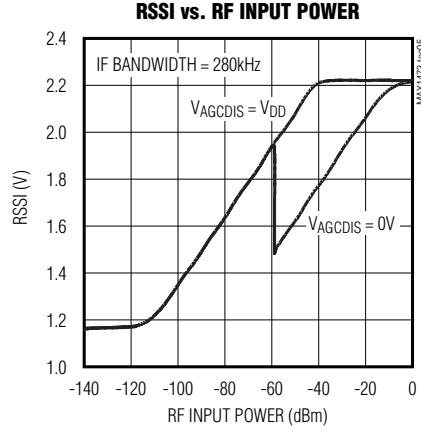
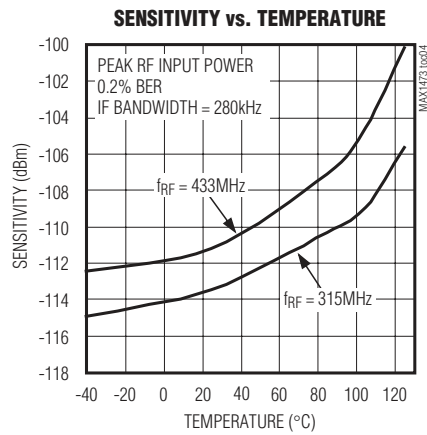
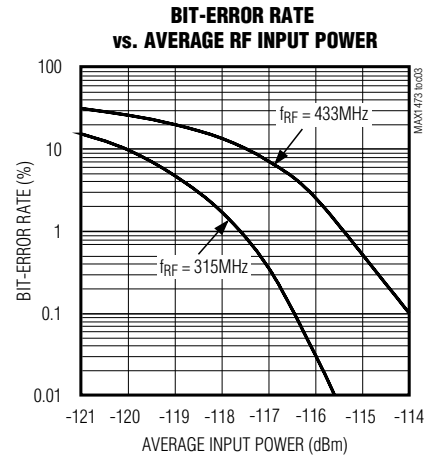
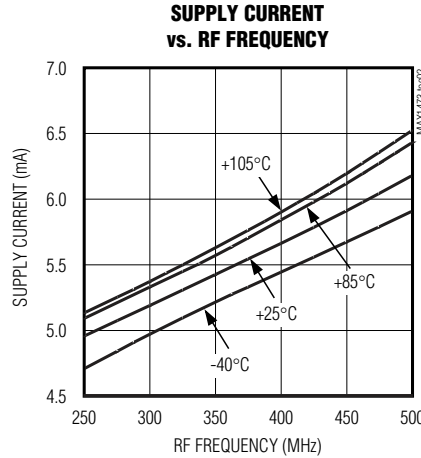
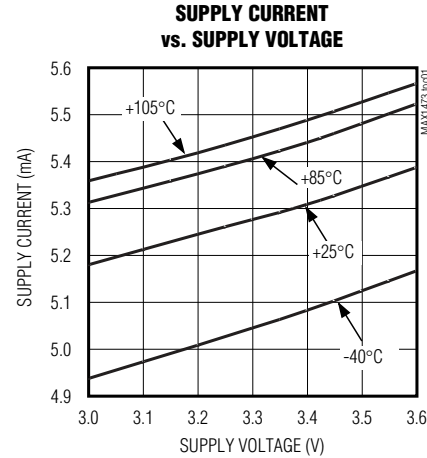

315MHz/433MHz ASK Superheterodyne Receiver with Extended Dynamic Range

Typical Operating Characteristics (continued)

(Typical Application Circuit, $V_{DD} = 3.3V$, $f_{RF} = 315MHz$, $T_A = +25^\circ C$, unless otherwise noted.)

MAX1473

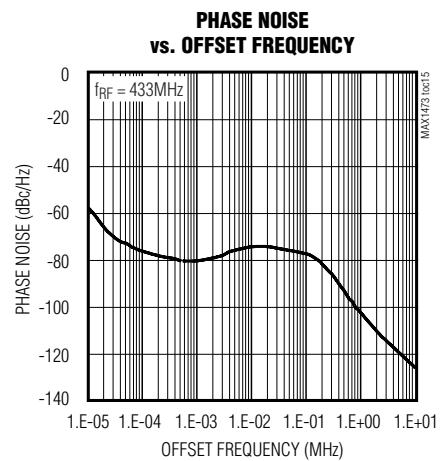
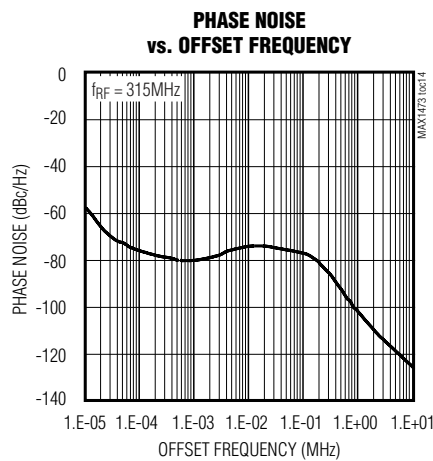
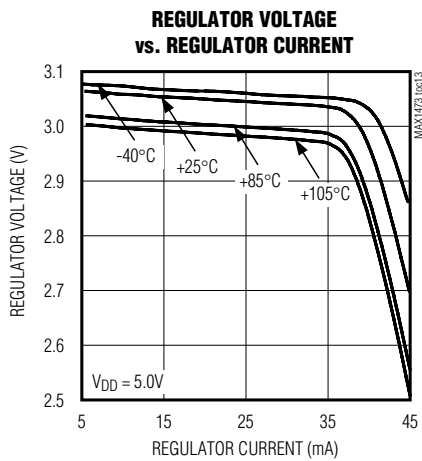
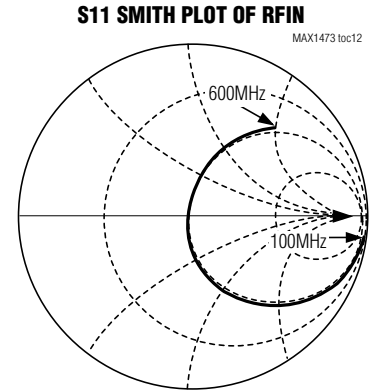
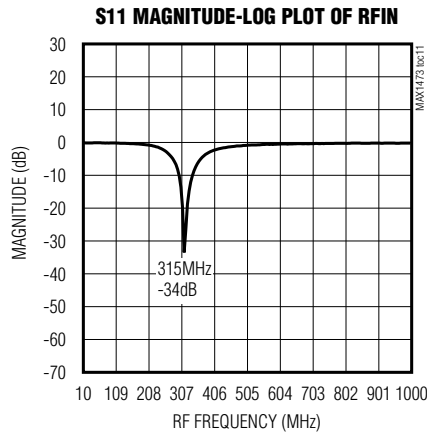
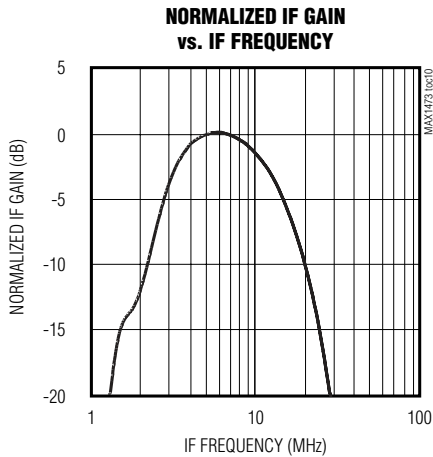

315MHz/433MHz ASK Superheterodyne Receiver with Extended Dynamic Range

Pin Description

PIN		NAME	FUNCTION
TSSOP	TQFN		
1	29	XTAL1	1st Crystal Input. (See the <i>Phase-Locked Loop</i> section.)
2, 7	4, 30	AVDD	Positive Analog Supply Voltage. For +5V operation, pin 2 is the output of an on-chip +3.2V low-dropout regulator and should be bypassed to AGND with a 0.1 μ F capacitor as close as possible to the pin. Pin 7 must be externally connected to the supply from pin 2 and bypassed to AGND with a 0.01 μ F capacitor as close as possible to the pin (see the <i>Voltage Regulator</i> section and the <i>Typical Application Circuit</i>).
3	31	LNAIN	Low-Noise Amplifier Input. (See the <i>Low-Noise Amplifier</i> section.)
4	32	LNASRC	Low-Noise Amplifier Source for External Inductive Degeneration. Connect inductor to ground to set LNA input impedance. (See the <i>Low-Noise Amplifier</i> section.)
5	2	AGND	Analog Ground
6	3	LNAOUT	Low-Noise Amplifier Output. Connect to mixer through an LC tank filter. (See the <i>Low-Noise Amplifier</i> section.)
8	5	MIXIN1	1st Differential Mixer Input. Connect through a 100pF capacitor to V _{DD3} side of the LC tank.
9	6	MIXIN2	2nd Differential Mixer Input. Connect through a 100pF capacitor to LC tank filter from LNAOUT.
10	7	AGND	Analog Ground
11	8	IRSEL	Image Rejection Select Pin. Set V _{IRSEL} = 0V to center image rejection at 315MHz. Leave IRSEL unconnected to center image rejection at 375MHz. Set V _{IRSEL} = V _{DD} to center image rejection at 433MHz.
12	9	MIXOUT	330 Ω Mixer Output. Connect to the input of the 10.7MHz bandpass filter.
13	10	DGND	Digital Ground
14	11	DVDD	Positive Digital Supply Voltage. Connect to both of the AVDD pins. Bypass to DGND with a 0.01 μ F capacitor as close as possible to the pin (see the <i>Typical Application Circuit</i>).
15	12	AGCDIS	AGC Control Pin. Pull high to disable AGC.
16	14	XTALSEL	Crystal Divider Ratio Select Pin. Drive XTALSEL low to select divider ratio of 64, or drive XTALSEL high to select divider ratio of 32.
17	15	IFIN1	1st Differential Intermediate Frequency Limiter Amplifier Input. Decouple to AGND with a 1500pF capacitor.
18	16	IFIN2	2nd Differential Intermediate Frequency Limiter Amplifier Input. Connect to the output of a 10.7MHz bandpass filter.
19	17	DFO	Data Filter Output
20	18	DSN	Negative Data Slicer Input
21	19	OPP	Noninverting Op-Amp Input for the Sallen-Key Data Filter
22	20	DFFB	Data Filter Feedback Node. Input for the feedback of the Sallen-Key data filter.
23	22	DSP	Positive Data Slicer Input
24	23	V _{DD5}	+5V Supply Voltage. Bypass to AGND with a 0.01 μ F capacitor as close as possible to the pin. For +5V operation, V _{DD5} is the input to an on-chip voltage regulator whose +3.2V output appears at the pin 2 AVDD pin. (See the <i>Voltage Regulator</i> section and the <i>Typical Application Circuit</i> .)
25	24	DATAOUT	Digital Baseband Data Output
26	26	PDOUT	Peak Detector Output
27	27	PWRDN	Power-Down Select Input. Drive this pin with a logic high to power on the IC.
28	28	XTAL2	2nd Crystal Input
—	1, 13, 21, 25	N.C.	No Connection
—	—	EP	Exposed Pad (TQFN Only). Connect EP to GND.

315MHz/433MHz ASK Superheterodyne Receiver with Extended Dynamic Range

Detailed Description

The MAX1473 CMOS superheterodyne receiver and a few external components provide the complete receive chain from the antenna to the digital output data. Depending on signal power and component selection, data rates as high as 100kbps can be achieved.

The MAX1473 is designed to receive binary ASK data modulated in the 300MHz to 450MHz frequency range. ASK modulation uses a difference in amplitude of the carrier to represent logic 0 and logic 1 data.

Voltage Regulator

For operation with a single +3.0V to +3.6V supply voltage, connect AVDD, DVDD, and VDD5 to the supply voltage. For operation with a single +4.5V to +5.5V supply voltage, connect VDD5 to the supply voltage. An on-chip voltage regulator drives one of the AVDD pins to approximately +3.2V. For proper operation, DVDD and both the AVDD pins must be connected together. Bypass VDD5, DVDD, and the pin 7 AVDD pin to AGND with 0.01μF capacitors, and the pin 2 AVDD pin to AGND with a 0.1μF capacitor, all placed as close as possible to the pins.

Low-Noise Amplifier

The LNA is an NMOS cascode amplifier with off-chip inductive degeneration that achieves approximately 16dB of power gain with a 2.0dB noise figure and an IIP3 of -12dBm. The gain and noise figure are dependent on both the antenna matching network at the LNA input and the LC tank network between the LNA output and the mixer inputs.

The off-chip inductive degeneration is achieved by connecting an inductor from LNASRC to AGND. This inductor sets the real part of the input impedance at LNAIN, allowing for a more flexible input impedance match, such as a typical PCB trace antenna. A nominal value for this inductor with a 50Ω input impedance is 15nH, but is affected by PCB trace. See the *Typical Operating Characteristics* for the relationship between the inductance and the LNA input impedance.

The AGC circuit monitors the RSSI output. When the RSSI output reaches 2.05V, which corresponds to an RF input level of approximately -57dBm, the AGC switches on the LNA gain reduction resistor. The resistor reduces the LNA gain by 35dB, thereby reducing the RSSI output by about 500mV. The LNA resumes high-gain mode when the RSSI level drops back below 1.45V (approximately -65dBm at RF input) for 150ms. The AGC has a hysteresis of ~8dB. With the AGC func-

tion, the MAX1473 can reliably produce an ASK output for RF input levels up to 0dBm with a modulation depth of 18dB.

The LC tank filter connected to LNAOUT comprises L3 and C2 (see the *Typical Application Circuit*). Select L3 and C2 to resonate at the desired RF input frequency. The resonant frequency is given by:

$$f = \frac{1}{2\pi\sqrt{L_{TOTAL} \times C_{TOTAL}}}$$

where:

$$L_{TOTAL} = L3 + L_{PARASITICS}$$

$$C_{TOTAL} = C2 + C_{PARASITICS}$$

L_{PARASITICS} and C_{PARASITICS} include inductance and capacitance of the PCB traces, package pins, mixer input impedance, LNA output impedance, etc. These parasitics at high frequencies cannot be ignored, and can have a dramatic effect on the tank filter center frequency. Lab experimentation should be done to optimize the center frequency of the tank.

Mixer

A unique feature of the MAX1473 is the integrated image rejection of the mixer. This device eliminates the need for a costly front-end SAW filter for most applications. Advantages of not using a SAW filter are increased sensitivity, simplified antenna matching, less board space, and lower cost.

The mixer cell is a pair of double balanced mixers that perform an IQ downconversion of the RF input to the 10.7MHz IF from a low-side injected LO (i.e., $f_{LO} = f_{RF} - f_{IF}$). The image-rejection circuit then combines these signals to achieve a minimum 45dB of image rejection over the full temperature range. Low-side injection is required due to the on-chip image rejection architecture. The IF output is driven by a source-follower biased to create a driving impedance of 330Ω; this provides a good match to the off-chip 330Ω ceramic IF filter. The voltage conversion gain is approximately 13dB when the mixer is driving a 330Ω load.

The IRSEL pin is a logic input that selects one of the three possible image-rejection frequencies. When V_{IRSEL} = 0V, the image rejection is tuned to 315MHz. V_{IRSEL} = V_{DD}/2 tunes the image rejection to 375MHz, and when V_{IRSEL} = V_{DD}, the image rejection is tuned to 433MHz. The IRSEL pin is internally set to V_{DD}/2 (image rejection at 375MHz) when it is left unconnected, thereby eliminating the need for an external V_{DD}/2 voltage.

315MHz/433MHz ASK Superheterodyne Receiver with Extended Dynamic Range

Phase-Locked Loop

The PLL block contains a phase detector, charge pump/integrated loop filter, VCO, asynchronous 64x clock divider, and crystal oscillator driver. Besides the crystal, this PLL does not require any external components. The VCO generates a low-side local oscillator (LO). The relationship between the RF, IF, and crystal reference frequencies is given by:

$$f_{XTAL} = (f_{RF} - f_{IF}) / (32 \times M)$$

where:

$$M = 1 (V_{XTALSEL} = V_{DD}) \text{ or } 2 (V_{XTALSEL} = 0V)$$

To allow the smallest possible IF bandwidth (for best sensitivity), the tolerance of the reference must be minimized.

Intermediate Frequency/RSSI

The IF section presents a differential 330Ω load to provide matching for the off-chip ceramic filter. The six internal AC-coupled limiting amplifiers produce an overall gain of approximately 65dB, with a bandpass filter-type response centered near the 10.7MHz IF frequency with a 3dB bandwidth of approximately 11.5MHz. The RSSI circuit demodulates the IF by producing a DC output proportional to the log of the IF signal level, with a slope of approximately 14.2mV/dB (see the *Typical Operating Characteristics*).

The AGC circuit monitors the RSSI output. When the RSSI output reaches 2.05V, which corresponds to an RF input level of approximately -57dBm, the AGC switches on the LNA gain reduction resistor. The resistor reduces the LNA gain by 35dB, thereby reducing the RSSI output by about 500mV. The LNA resumes high-gain mode when the RSSI level drops back below 1.45V (approximately -65dBm at RF input) for 150ms. The AGC has a hysteresis of ~8dB. With the AGC function, the MAX1473 can reliably produce an ASK output for RF input levels up to 0dBm with modulation depth of 18dB.

Applications Information

Crystal Oscillator

The XTAL oscillator in the MAX1473 is designed to present a capacitance of approximately 3pF between the XTAL1 and XTAL2. If a crystal designed to oscillate with a different load capacitance is used, the crystal is pulled away from its stated operating frequency, introducing an error in the reference frequency. Crystals designed to operate with higher differential load capacitance always pull the reference frequency higher. For example, a 4.7547MHz crystal designed to operate with a 10pF load capacitance oscillates at 4.7563MHz with the MAX1473, causing the receiver to be tuned to 315.1MHz rather than 315.0MHz, an error of about 100kHz, or 320ppm.

In actuality, the oscillator pulls every crystal. The crystal's natural frequency is really below its specified frequency, but when loaded with the specified load capacitance, the crystal is pulled and oscillates at its specified frequency. This pulling is already accounted for in the specification of the load capacitance.

Additional pulling can be calculated if the electrical parameters of the crystal are known. The frequency pulling is given by:

$$f_p = \frac{C_m}{2} \left(\frac{1}{C_{case} + C_{load}} - \frac{1}{C_{case} + C_{spec}} \right) \times 10^6$$

where:

f_p is the amount the crystal frequency pulled in ppm.

C_m is the motional capacitance of the crystal.

C_{case} is the case capacitance.

C_{spec} is the specified load capacitance.

C_{load} is the actual load capacitance.

When the crystal is loaded as specified, i.e., $C_{load} = C_{spec}$, the frequency pulling equals zero.

Data Filter

The data filter is implemented as a 2nd-order lowpass Sallen-Key filter. The pole locations are set by the combination of two on-chip resistors and two external capacitors. Adjusting the value of the external capacitors changes the corner frequency to optimize for different data rates. The corner frequency should be set to approximately 1.5 times the fastest expected data rate from the transmitter. Keeping the corner frequency near the data rate rejects any noise at higher frequencies, resulting in an increase in receiver sensitivity.

The configuration shown in Figure 1 can create a Butterworth or Bessel response. The Butterworth filter offers a very flat amplitude response in the passband and a rolloff rate of 40dB/decade for the two-pole filter. The Bessel filter has a linear phase response, which works well for filtering digital data. To calculate the value of C7 and C6, use the following equations along with the coefficients in Table 1:

Table 1. Coefficients to Calculate C7 and C6

FILTER TYPE	a	b
Butterworth (Q = 0.707)	1.414	1.000
Bessel (Q = 0.577)	1.3617	0.618

315MHz/433MHz ASK Superheterodyne Receiver with Extended Dynamic Range

$$C7 = \frac{b}{a(100k)(\pi)(f_c)}$$

$$C6 = \frac{a}{4(100k)(\pi)(f_c)}$$

where f_c is the desired 3dB corner frequency.
 For example, choose a Butterworth filter response with a corner frequency of 5kHz:

$$C7 = \frac{1.000}{(1.414)(100k\Omega)(3.14)(5kHz)} \approx 450pF$$

Choosing standard capacitor values changes C7 to 470pF and C6 to 220pF, as shown in the *Typical Application Circuit*.

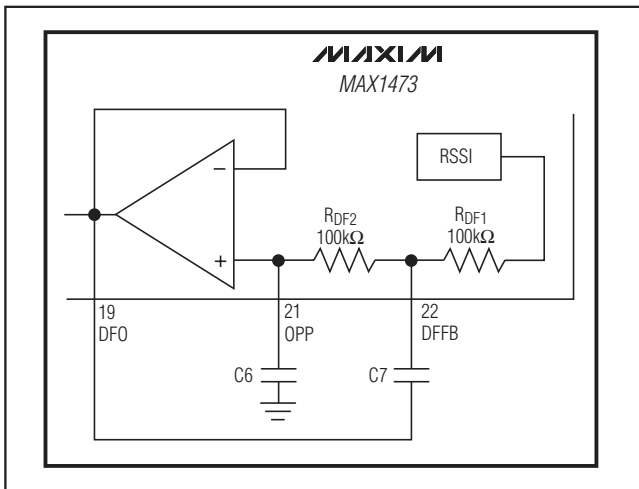

Figure 1. Sallen-Key Lowpass Data Filter

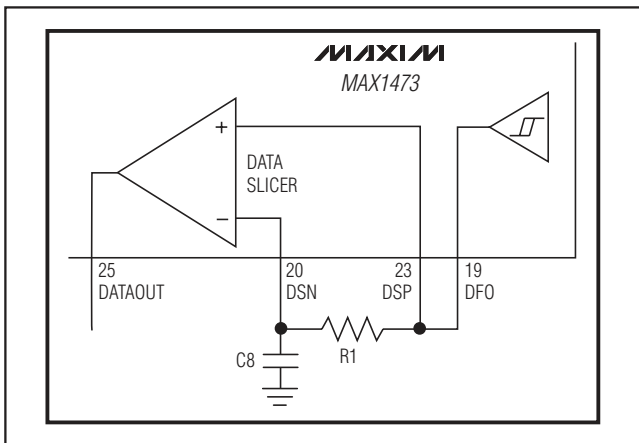

Figure 2. Generating Data Slicer Threshold

Data Slicer
 The purpose of the data slicer is to take the analog output of the data filter and convert it to a digital signal. This is achieved by using a comparator and comparing the analog input to a threshold voltage. One input is supplied by the data filter output. Both comparator inputs are accessible off chip to allow for different methods of generating the slicing threshold, which is applied to the second comparator input.

The suggested data slicer configuration uses a resistor (R1) connected between DSN and DSP with a capacitor (C8) from DSN to DGND (Figure 2). This configuration averages the analog output of the filter and sets the threshold to approximately 50% of that amplitude. With this configuration, the threshold automatically adjusts as the analog signal varies, minimizing the possibility for errors in the digital data. The sizes of R1 and C8 affect how fast the threshold tracks to the analog amplitude. Be sure to keep the corner frequency of the RC circuit much lower than the lowest expected data rate.

Note that a long string of zeros or 1's can cause the threshold to drift. This configuration works best if a coding scheme, such as Manchester coding, which has an equal number of zeros and 1's, is used.

To prevent continuous toggling of DATAOUT in the absence of an RF signal due to noise, hysteresis can be added to the data slicer as shown in Figure 3.

For further information on Data Slicer options, please refer to Maxim Application Note 3671, *Data Slicing Techniques for UHF ASK Receivers*.

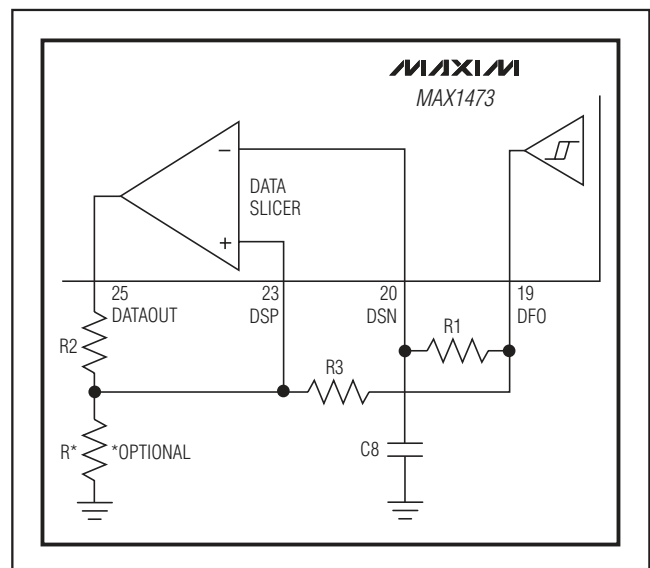

Figure 3. Generating Data Slicer Hysteresis

315MHz/433MHz ASK Superheterodyne Receiver with Extended Dynamic Range

Peak Detector

The peak detector output (PDOUT), in conjunction with an external RC filter, creates a DC output voltage equal to the peak value of the data signal. The resistor provides a path for the capacitor to discharge, allowing the peak detector to dynamically follow peak changes of the data filter output voltage. For faster receiver startup, the circuit shown in Figure 4 can be used.

Layout Considerations

A properly designed PCB is an essential part of any RF/microwave circuit. On high-frequency inputs and outputs, use controlled-impedance lines and keep them as short as possible to minimize losses and radiation. At high frequencies, trace lengths that are on the order of $\lambda/10$ or longer act as antennas.

Keeping the traces short also reduces parasitic inductance. Generally, 1in of a PCB trace adds about 20nH of parasitic inductance. The parasitic inductance can have a dramatic effect on the effective inductance of a passive component. For example, a 0.5in trace connecting a 100nH inductor adds an extra 10nH of inductance or 10%.

To reduce the parasitic inductance, use wider traces and a solid ground or power plane below the signal traces. Also, use low-inductance connections to ground on all GND pins, and place decoupling capacitors close to all power-supply pins.

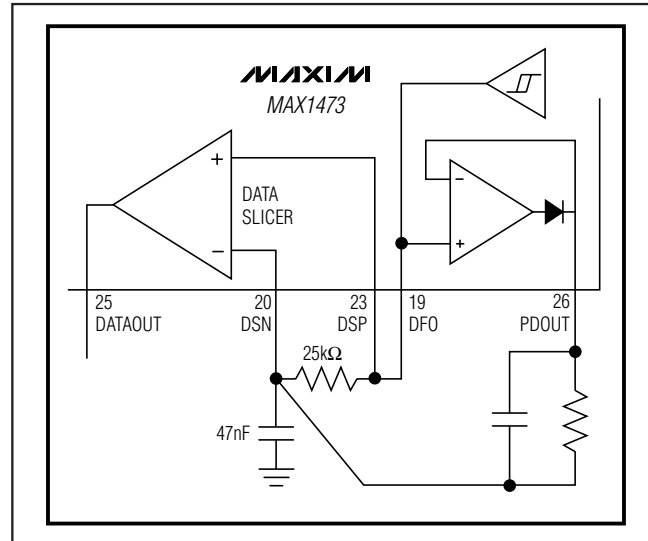

Figure 4. Using PDOUT for Faster Startup

Control Interface Considerations

When operating the MAX1473 with a +4.5V to +5.5V supply voltage, the PWRDN and AGCDIS pins may be driven by a microcontroller with either 3V or 5V interface logic levels. When operating the MAX1473 with a +3.0V to +3.6V supply, the microcontroller must produce logic levels which conform to the V_{IH} and V_{IL} specifications in the DC Electrical Characteristics Table for the MAX1473.

315MHz/433MHz ASK Superheterodyne Receiver with Extended Dynamic Range

MAX1473

Table 2. Component Values for Typical Application Circuit

COMPONENT	VALUE FOR $f_{RF} = 433\text{MHz}$	VALUE FOR $f_{RF} = 315\text{MHz}$	DESCRIPTION
C1	100pF	100pF	5%
C2	2.7pF	4.7pF	$\pm 0.1\text{pF}$
C3	100pF	100pF	5%
C4	100pF	100pF	5%
C5	1500pF	1500pF	10%
C6	220pF	220pF	5%
C7	470pF	470pF	5%
C8	0.47 μF	0.47 μF	20%
C9	220pF	220pF	10%
C10	0.01 μF	0.01 μF	20%
C11	0.1 μF	0.1 μF	20%
C12	15pF	15pF	Depends on XTAL
C13	15pF	15pF	Depends on XTAL
C14	0.01 μF	0.01 μF	20%
C15	0.01 μF	0.01 μF	20%
L1	56nH	120nH	5% or better**
L2	15nH	15nH	5% or better**
L3	15nH	27nH	5% or better**
R1	5.1k Ω	5.1k Ω	5%
R2	Open	Open	—
R3	Short	Short	—
X1(+64)	6.6128MHz*	4.7547MHz*	Crystek or Hong Kong X'tal
X1(+32)	13.2256MHz*	9.5094MHz*	Crystek or Hong Kong X'tal
Y1	10.7MHz ceramic filter	10.7MHz ceramic filter	Murata

*Crystal frequencies shown are for +64 ($V_{XTALSEL} = 0V$) and +32 ($V_{XTALSEL} = V_{DD}$).

**Wirewound recommended.

315MHz/433MHz ASK Superheterodyne Receiver with Extended Dynamic Range

Typical Application Circuit

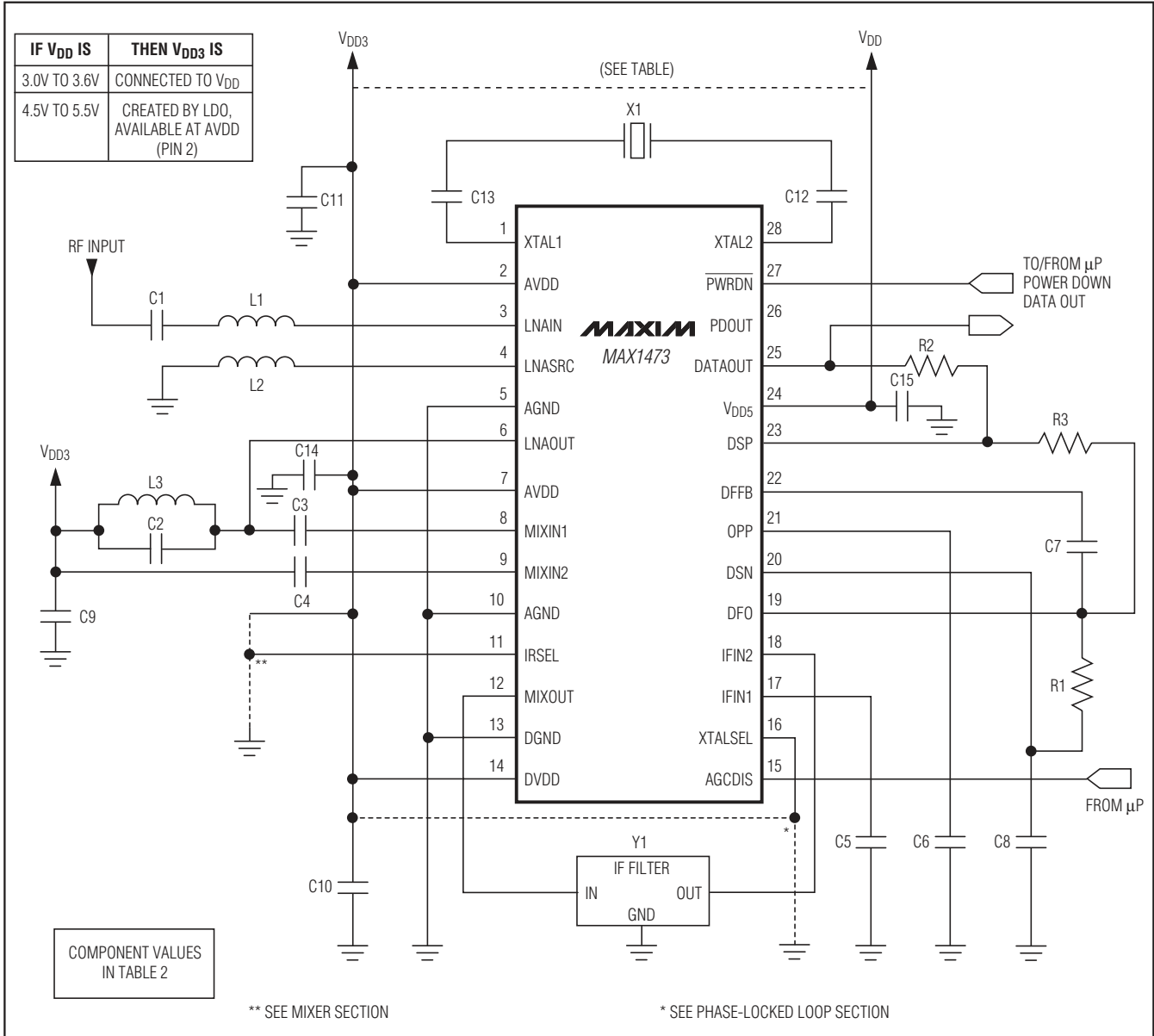

Chip Information

PROCESS: CMOS

315MHz/433MHz ASK Superheterodyne Receiver with Extended Dynamic Range

Functional Diagram

MAX1473

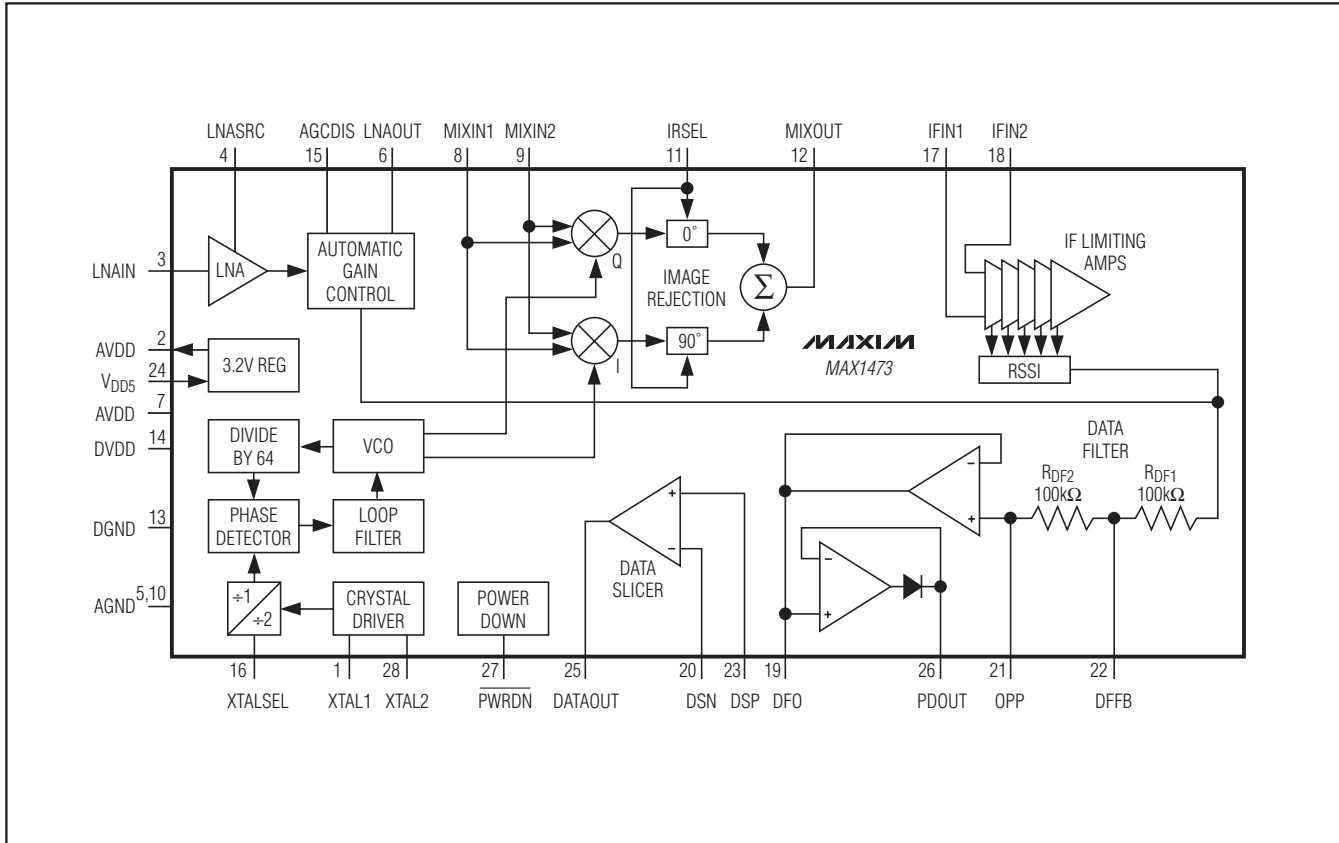

Package Information

For the latest package outline information and land patterns (footprints), go to www.maxim-ic.com/packages. Note that a "+", "#", or "-" in the package code indicates RoHS status only. Package drawings may show a different suffix character, but the drawing pertains to the package regardless of RoHS status.

PACKAGE TYPE	PACKAGE CODE	OUTLINE NO.	LAND PATTERN NO.
28 TSSOP	U28+1	21-0066	90-0171
32 Thin QFN-EP	T3255+3	21-0140	90-0001

315MHz/433MHz ASK Superheterodyne Receiver with Extended Dynamic Range

Revision History

REVISION NUMBER	REVISION DATE	DESCRIPTION	PAGES CHANGED
4	5/10	Added lead-free parts and exposed pad in <i>Ordering Information</i> and <i>Pin Description</i> tables	1, 8
5	1/11	Updated <i>Absolute Maximum Ratings</i> , <i>AC Electrical Characteristics</i> , <i>Pin Description</i> , <i>Layout Considerations</i> , <i>Typical Application Circuit</i> , <i>Functional Diagram</i> , and <i>Package Information</i> ; added <i>Voltage Regulator</i> section to the <i>Detailed Description</i> section	2, 3, 4, 8, 9, 12, 13, 14
6	1/12	Updated <i>DC Electrical</i> and <i>AC Electrical Characteristics</i> tables, replaced TOC 4, updated Tables 1 and 2 and Figure 1; updated <i>Phase-Locked Loop</i> , <i>Data Filter</i> , <i>Data Slicer</i> , and <i>Layout Considerations</i> sections	3, 5, 6, 10–13

Maxim cannot assume responsibility for use of any circuitry other than circuitry entirely embodied in a Maxim product. No circuit patent licenses are implied. Maxim reserves the right to change the circuitry and specifications without notice at any time. The parametric values (min and max limits) shown in the Electrical Characteristics table are guaranteed. Other parametric values quoted in this data sheet are provided for guidance.