

# Product data sheet

Specifications



## Limit switch, Limit switches XC Standard, XCMD, metal end plunger, 1NC+1 NO, snap, M12

XCMD2110M12

### Main

Range of product	Telemecanique Limit switches XC Standard
Series name	Standard format
Product or component type	Limit switch
Device short name	XCMD
Sensor design	Miniature
Body type	Plug-in body
Head type	Plunger head
Material	Metal
Body material	Zamak
Head material	Zamak
Fixing mode	By the body
Movement of operating head	Linear
Type of operator	Spring return plunger metal
Type of approach	Vertical approach, 1 direction
Number of poles	1
Contacts type and composition	1 C/O
Contact operation	Snap action

### Complementary

Switch actuation	On end
Electrical connection	Male connector M12, 4 pins
Contacts insulation form	Za
Positive opening	Without
Minimum force for tripping	8.5 N
Minimum actuation speed	0.01 m/min
Maximum actuation speed	0.5 m/s
[Ie] rated operational current	1.5 A at 240 V, AC-15 conforming to EN/IEC 60947-5-1 appendix A 0.1 A at 250 V, DC-13 conforming to EN/IEC 60947-5-1 appendix A
[Ithe] conventional enclosed thermal current	3 A

<b>[Ui] rated insulation voltage</b>	250 V (pollution degree 3) conforming to IEC 60947-5-1
<b>Maximum resistance across terminals</b>	25 mOhm conforming to IEC 60255-7 category 3
<b>[Uimp] rated impulse withstand voltage</b>	2.5 kV conforming to IEC 60664 2.5 kV conforming to IEC 60947-1
<b>Short-circuit protection</b>	4 A cartridge fuse, type gG
<b>Electrical durability</b>	5000000 cycles, DC-13, 24 V, 3 W, operating rate <60 cyc/mn, load factor: 0.5 conforming to IEC 60947-5-1 appendix C 5000000 cycles, DC-13, 48 V, 2 W, operating rate <60 cyc/mn, load factor: 0.5 conforming to IEC 60947-5-1 appendix C 5000000 cycles, DC-13, 120 V, 1 W, operating rate <60 cyc/mn, load factor: 0.5 conforming to IEC 60947-5-1 appendix C
<b>Mechanical durability</b>	10000000 cycles
<b>Width</b>	30 mm
<b>Height</b>	50 mm
<b>Depth</b>	16 mm
<b>Net weight</b>	0.085 kg

## Environment

<b>Shock resistance</b>	25 gn for 18 ms conforming to IEC 60068-2-27
<b>Vibration resistance</b>	5 gn (f= 10...500 Hz) conforming to IEC 60068-2-6
<b>IP degree of protection</b>	IP66 conforming to IEC 60529 IP67 conforming to IEC 60529 IP68 conforming to IEC 60529
<b>IK degree of protection</b>	IK06 conforming to EN 62262
<b>Electrical shock protection class</b>	Class I conforming to IEC 61140 Class I conforming to NF C 20-030
<b>Ambient air temperature for operation</b>	-25...70 °C
<b>Ambient air temperature for storage</b>	-40...70 °C
<b>Protective treatment</b>	TC
<b>Product certifications</b>	UL CSA CCC
<b>Standards</b>	EN/IEC 60947-5-1 EN/IEC 60204-1 CSA C22.2 No 14 UL 508

## Packing Units

<b>Unit Type of Package 1</b>	PCE
<b>Number of Units in Package 1</b>	1
<b>Package 1 Height</b>	1.7 cm
<b>Package 1 Width</b>	6.1 cm
<b>Package 1 Length</b>	5.3 cm
<b>Package 1 Weight</b>	84.0 g
<b>Unit Type of Package 2</b>	S02
<b>Number of Units in Package 2</b>	100
<b>Package 2 Height</b>	15 cm
<b>Package 2 Width</b>	30 cm
<b>Package 2 Length</b>	40 cm

Package 2 Weight	9.05 kg
Unit Type of Package 3	P06
Number of Units in Package 3	1600
Package 3 Height	75 cm
Package 3 Width	60 cm
Package 3 Length	80 cm
Package 3 Weight	153 kg

## Offer Sustainability

Sustainable offer status	Green Premium product
REACH Regulation	<a href="#">REACH Declaration</a>
EU RoHS Directive	Pro-active compliance (Product out of EU RoHS legal scope) <a href="#">EU RoHS Declaration</a>
Mercury free	Yes
RoHS exemption information	<a href="#">Yes</a>
Environmental Disclosure	<a href="#">Product Environmental Profile</a>
Circularity Profile	<a href="#">End of Life Information</a>
California proposition 65	WARNING: This product can expose you to chemicals including: Diisononyl phthalate (DINP), which is known to the State of California to cause cancer, and Di-isodecyl phthalate (DIDP), which is known to the State of California to cause birth defects or other reproductive harm. For more information go to <a href="http://www.P65Warnings.ca.gov">www.P65Warnings.ca.gov</a>

## Contractual warranty

Warranty	18 months
----------	-----------

**Dimensions**

---

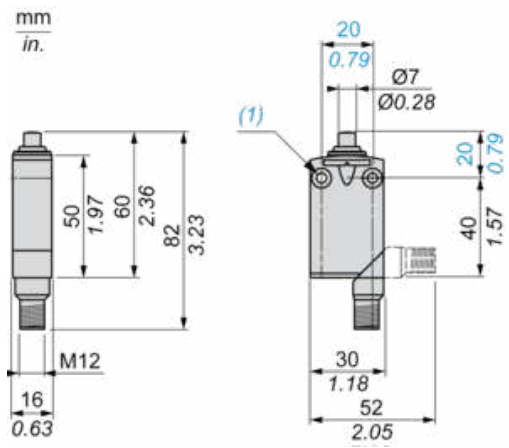

(1) 2 fixing holes Ø 4.2 mm, counterbored Ø 8 mm by 4 mm deep.

**Setting-up**

---

**Plunger or Multi-directional Heads**

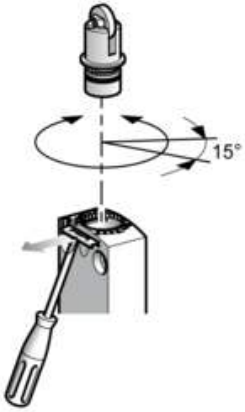

**Wiring Diagram**

---

**Single-pole CO Snap Action + Integral M12 4-pin Connector**

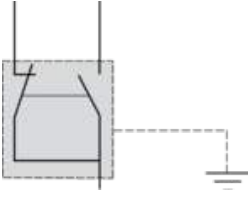

**Wiring Diagram**

---

4-pin, M12, 3A-250V

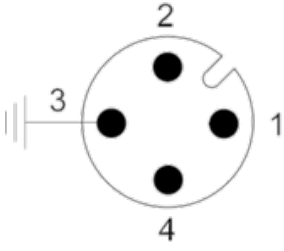

- 1 : Common
- 2 : NC
- 3 : Grounding
- 4 : NO

**Characteristics of Actuation**

---

**Switch Actuation on End**

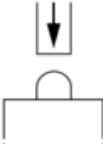



**Functional Diagram**

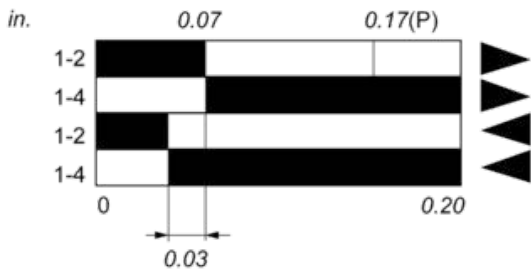
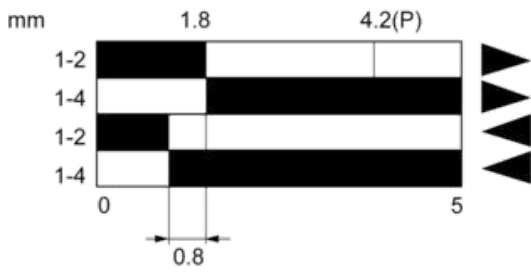

- (1)
- (2)
- ▶ (3)
- ◀ (4)

- (P) Positive opening point
- (1) Closed
- (2) Open
- (4) Tripping
- (5) Resetting

**Recommended replacement(s)**