

Ultrasonic sensor

UC4000-L2-I-V15



- Sensor head bidirectional and rotatable
- Function indicators visible from all directions
- Quick mounting bracket
- Selectable sound lobe width
- Programmable

Single head system



Dimensions

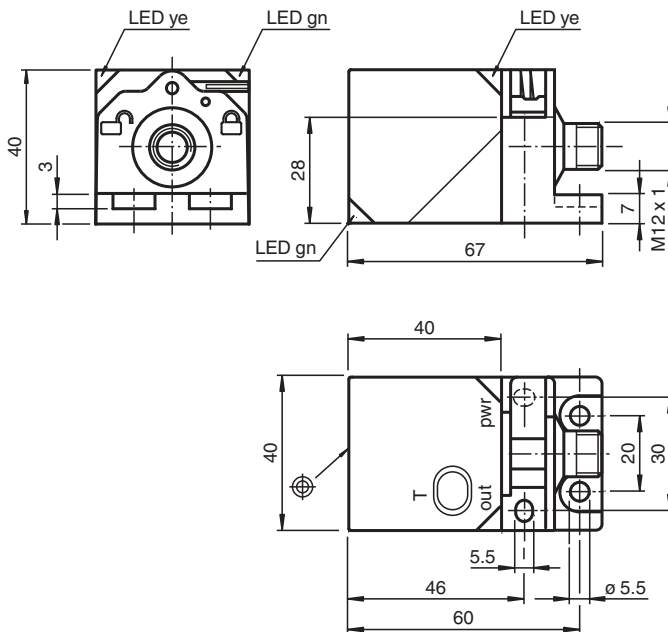

Technical Data

General specifications

| | |
|-----------------------|-----------------|
| Sensing range | 200 ... 4000 mm |
| Adjustment range | 240 ... 4000 mm |
| Dead band | 0 ... 200 mm |
| Standard target plate | 100 mm x 100 mm |
| Transducer frequency | approx. 85 kHz |

Nominal ratings

| | |
|--------------------------------|--|
| Response delay | minimum: 110 ms factory setting: 615 ms |
| Time delay before availability | t_v ≤ 1600 ms |

Release date: 2022-11-23 Date of issue: 2022-11-23 Filename: 277770_eng.pdf

Refer to "General Notes Relating to Pepperl+Fuchs Product Information".

Pepperl+Fuchs Group
www.pepperl-fuchs.com

USA: +1 330 486 0001
fa-info@us.pepperl-fuchs.com

Germany: +49 621 776 1111
fa-info@de.pepperl-fuchs.com

Singapore: +65 6779 9091
fa-info@sg.pepperl-fuchs.com

pepperl+fuchs

Technical Data

| | | |
|---|-------|---|
| Indicators/operating means | | |
| LED green | | Operating display |
| LED yellow | | object in evaluation range |
| LED red | | error |
| Electrical specifications | | |
| Operating voltage | U_B | 10 ... 30 V DC , ripple 10 % _{SS} |
| No-load supply current | I_0 | ≤ 50 mA |
| Interface | | |
| Interface type | | Serial interface (programming adapter required) 9600 BPS, no parity, 8 data bits, 1 stop bit |
| Input/Output | | |
| Input/output type | | 1 synchronization connection, bidirectional |
| 0 Level | | 0 ... 1 V |
| 1 Level | | 4 V ... U_B |
| Input impedance | | > 12 kΩ |
| Output rated operating current | | < 12 mA |
| Pulse length | | 0.5 ... 300 ms (level 1) |
| Pulse interval | | ≥ 62.5 ms (level 0) |
| Synchronization frequency | | |
| Common mode operation | | ≤ 16 Hz |
| Multiplex operation | | ≤ 17 Hz / n , n = number of sensors , n ≤ 10 (factory setting: n = 5) |
| Input | | |
| Input type | | 1 program input |
| Level (evaluation limit 1) | | 0 ... 1 V |
| Level (evaluation limit 2) | | 4 V ... U_B |
| Input impedance | | > 12 kΩ |
| Pulse length | | 2 ... 10 s |
| Output | | |
| Output type | | 1 analog output 4 ... 20 mA |
| Resolution | | Evaluation range [mm]/3200, however ≥ 0.4 mm |
| Deviation of the characteristic curve | | ≤ 0.2 % of full-scale value |
| Repeat accuracy | | ≤ 0.1 % of full-scale value |
| Load impedance | | ≤ 500 Ω at $U_B ≥ 14V$ ≤ 300 Ω at $U_B < 14V$ |
| Temperature influence | | ≤ 1.5 % of full-scale value |
| Compliance with standards and directives | | |
| Standard conformity | | |
| Standards | | EN IEC 60947-5-2:2020 IEC 60947-5-2:2019 EN 60947-5-7:2003 IEC 60947-5-7:2003 |
| Approvals and certificates | | |
| UL approval | | cULus Listed, General Purpose |
| CCC approval | | CCC approval / marking not required for products rated ≤36 V |
| Ambient conditions | | |
| Ambient temperature | | -25 ... 70 °C (-13 ... 158 °F) |
| Storage temperature | | -40 ... 85 °C (-40 ... 185 °F) |
| Mechanical specifications | | |
| Connection type | | Connector plug M12 x 1 , 5-pin |
| Degree of protection | | IP67 |
| Material | | |
| Housing | | PA-GF35 |
| Transducer | | epoxy resin/hollow glass sphere mixture; polyurethane foam |
| Mass | | 120 g |

Release date: 2022-11-23 Date of issue: 2022-11-23 Filename: 277770_eng.pdf

Refer to "General Notes Relating to Pepperl+Fuchs Product Information".

 Pepperl+Fuchs Group
www.pepperl-fuchs.com

 USA: +1 330 486 0001
fa-info@us.pepperl-fuchs.com

 Germany: +49 621 776 1111
fa-info@de.pepperl-fuchs.com

 Singapore: +65 6779 9091
fa-info@sg.pepperl-fuchs.com

 **PEPPERL+FUCHS**

Technical Data

Factory settings

| | |
|----------------------|---|
| Output | evaluation limit A1: 240 mm evaluation limit A2: 4000 mm output function: rising ramp |
| Beam width | wide |
| Evaluation procedure | low-pass behavior |

General information

| | |
|---------------------------|--|
| Supplementary information | Switch settings of the external programming adapter: "output load": pull-down "output logic": noninv |
|---------------------------|--|

Connection

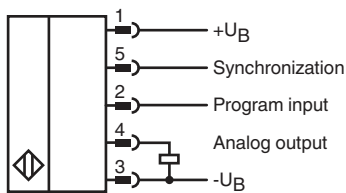

Connection Assignment

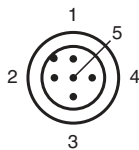

Wire colors in accordance with EN 60947-5-2

| | | |
|---|----|---------|
| 1 | BN | (brown) |
| 2 | WH | (white) |
| 3 | BU | (blue) |
| 4 | BK | (black) |
| 5 | GY | (gray) |



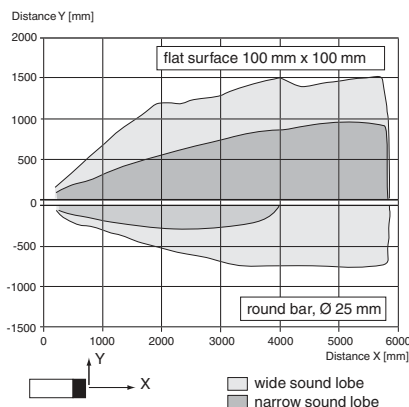

Characteristic Curve

Characteristic response curve



Release date: 2022-11-23 Date of issue: 2022-11-23 Filename: 277770_eng.pdf

Accessories

| | | |
|---|-----------------------|---|
|  | UC-PROG1-USB | Programming adapter |
|  | V15-G-2M-PVC | Female cordset single-ended M12 straight A-coded, 5-pin, PVC cable grey |
|  | UB-PROG2 | Programming unit |
|  | Microsoft .NET | Connection Software |

Release date: 2022-11-23 Date of issue: 2022-11-23 Filename: 277770_eng.pdf

Refer to "General Notes Relating to Pepperl+Fuchs Product Information".

Pepperl+Fuchs Group
www.pepperl-fuchs.com

USA: +1 330 486 0001
fa-info@us.pepperl-fuchs.com

Germany: +49 621 776 1111
fa-info@de.pepperl-fuchs.com

Singapore: +65 6779 9091
fa-info@sg.pepperl-fuchs.com

Programming

Programming the sensor functions

The sensor features an analog output with two programmable limit values. The limit values and output operating modes can be programmed in three different ways:

- Using the programming key on the sensor
- By activating the 0-V or +U_B supply voltage on the programming input (for programming the limit values only)
- Using the serial interface on the sensor. This method requires an external interface module.

The programming methods using the programming key and programming input are described below. To use the serial interface on the sensor for programming, see the software description. The processes for programming the limit values and the sensor operating modes run completely independently and do not influence one another.

Notes:

- The sensor can only be programmed during the first 5 minutes after switching on. This time is extended during the actual programming process. The option of programming the sensor is revoked if no programming activities take place for 5 minutes.
- Programming can be aborted at any time during the process, without changing the sensor settings. To do so, press and hold the programming key for 10 seconds.

Programming the limit value of the analog characteristic

Note

A flashing red LED during the programming process indicates unreliable object detection. Should this occur, correct the alignment of the object until the yellow LED flashes. Only then will the settings be transferred to the sensor memory.

Programming the limit values using the programming key

Programming the near characteristic limit value

1. Position the object at the site of the required near limit value
2. Press and hold the programming key for 2 seconds (yellow LED flashes)
3. Briefly press the programming key (green LED flashes 3 times as confirmation). The sensor returns to normal mode.

Programming the distant characteristic limit value

1. Position the object at the site of the required distant limit value
2. Press and hold the programming key for 2 seconds (yellow LED flashes)
3. Press and hold the programming key for 2 seconds (green LED flashes 3 times as confirmation). The sensor returns to normal mode.

Programming the limit values using the programming input

Notes:

- Before starting the programming process, the programming input must be disconnected for at least 2 seconds.
- If the operating voltage (0 V or +U_B) is applied for >10 seconds, the sensor returns to normal mode without changing the settings. To ensure that programming is successful, disconnect the programming input before this time elapses.
- If the programming input is not used, it should be permanently connected at 0 V.
- If programming adapter UB-PROG2 is used for the programming process, the "A1" key is equivalent to 0 V and "A2" to +U_B. In this case, ensure that the wire that is connected to the programming input is open at the end of the sensor cable (not clamped at potential).

Programming the near characteristic limit value

1. Position the object at the site of the required near limit value
2. Connect the programming input to 0 V for 2 seconds (yellow LED flashes, then the green LED flashes three times as confirmation). The sensor then returns to normal mode.

Programming the distant characteristic limit value

1. Position the object at the site of the required distant limit value
2. Connect the programming input to +U_B for 2 seconds (yellow LED flashes, then the green LED flashes three times as confirmation). The sensor then returns to normal mode.

Programming the sensor operating modes

The sensor features a two-stage process for programming the sensor operating modes. During this process, you can program:

1. The curve of the analog characteristic
2. The shape of the sound cone

These two stages of the process are programmed in succession. To switch from one programming function to the next, press and hold the programming key for 2 seconds.

Press and hold the programming key for 5 seconds to switch to the process for programming the sensor operating modes.

Programming the curve of the analog characteristic

1. The green LED is now flashing. The number of flashes indicates the output function currently programmed:
 - 1x: rising ramp
 - 2x: falling ramp
 - 3x: zero-point line
2. Briefly press the programming key to switch between the different curves and press again to select the required curve.
3. Press and hold the programming key for 2 seconds to save the selection and switch to the process for programming the sound cone.

Programming the shape of the sound cone

1. The red LED is now flashing. The number of flashes indicates the sound cone shape currently programmed:
 1x: narrow
 2x: medium
 3x: wide
2. Briefly press the programming key to navigate through the different sound cone shapes in succession and press again to select the required sound cone shape.
3. Press and hold the programming key for 2 seconds to save the selection and return to normal mode.

Factory Setting

Reset Sensor to Factory Settings

The sensor has a feature to reset to factory settings

1. Disconnect the sensor from power supply
 2. Press and hold the Programming Button
 3. Connect Sensor to power supply (yellow and red LED flash simultaneously for 5 s then yellow and green LED flash simultaneously)
 4. Release Programming Button
- The sensor now operates with default factory settings.

Factory settings

See technical data.

Indication

The sensor features three LEDs for indicating statuses.

| | Green LED | Yellow LED | Red LED |
|---|-------------|---|-------------|
| In normal mode | | | |
| Fault-free function | On | Object in the analog characteristic range retains previous status | Off |
| Fault (e.g. compressed air) | Off | | On |
| When programming the limit values | | | |
| Object detected | Off | Flashing | Off |
| No object detected | Off | Off | Flashing |
| Confirmation of successful programming | Flashing 3x | Off | Off |
| Warning in the event of invalid programming | Off | Off | Flashing 3x |
| When programming the operating mode | | | |
| Programming the output function | Flashing | Off | Off |
| Programming the sound cone | Off | Off | Flashing |

Commissioning

Synchronization

This sensor features a synchronization input for suppressing ultrasonic mutual interference ("cross talk"). If this input is not connected, the sensor will operate freewheeling using internally generated clock pulses. It can be synchronized by applying an external square wave or by means of appropriate programming via the serial interface. Each falling edge of the synchronization pulse triggers transmission of a single ultrasonic pulse. If the synchronization signal remains low for ≥ 1 second, the sensor will revert to normal operating mode. Normal operating mode can also be activated by opening the signal connection to the synchronization input. (See note below)

If the synchronization input goes to a high level for > 1 second, the sensor will switch to standby mode, indicated by the green LED. In this mode, the output(s) will remain in the last valid output state. When using the external synchronization feature, please refer to the software description.

Note:

If the option for synchronization is not used, the synchronization input has to be connected to ground (0V) or the sensor has to be operated via a V1 cordset (4-pin).

The synchronization function cannot be activated during programming mode and vice versa.

The following synchronization modes are possible:

1. Several sensors (max. number see technical data) can be synchronized together by interconnecting their respective synchronization inputs. In this case, each sensor alternately transmits ultrasonic pulses in a self multiplexing mode. No two sensors will transmit pulses at the same time. (See note below)
2. Several sensors (max. number see technical data) can be synchronized together by interconnecting their respective synchronization inputs. Due to programming via the sensors interface one sensor acts as a master device, all the others as slave devices. (see description of the interface) In this master / slave mode the sensors are triggered in parallel and are synchronized by a common synchronization pulse, provided by the master device.
3. Multiple sensors can be controlled by the same external synchronization signal. In this mode the sensors are triggered in parallel and are synchronized by a common external synchronization pulse. All sensors must be parameterized for external synchronization by means of the sensor interface. See software description.
4. A separate synchronization pulse can be sent to each individual sensor. In this mode the sensors operate in external multiplex mode. (See note below). All sensors must be parameterized for external synchronization by means of the sensor interface. See software description.
5. A high level (+U_B) or a low level (-U_B) on the synchronization input switches the sensor to standby mode if it is parameterized for external synchronization.

Note:

Release date: 2022-11-23 Date of issue: 2022-11-23 Filename: 277770_eng.pdf

Sensor response times will increase proportionally to the number of sensors that are in the synchronization string. This is a result of the multiplexing of the ultrasonic transmit and receive signal and the resulting increase in the measurement cycle time.

Note:

The sensors synchronization input delivers an output current in case of low level and burdens with its input impedance in case of high level. Please pay attention that the synchronizing device needs to have that driver capability:

driver current against $+U_B \geq n \cdot \text{high-level/input impedance}$ (n = number of sensors to be synchronized)

driver current against $0V \geq n \cdot \text{output current}$ (n = number of sensors to be synchronized).

Release date: 2022-11-23 Date of issue: 2022-11-23 Filename: 277770_eng.pdf