



TAOGLAS®



Datasheet

Gemini

Part No:
LMA101.A.BI.001

Description:

Gemini 2*5G/4G MIMO Magnetic/Desk/Wall Mount Antenna

Features:

- 5G/4G MIMO Antenna
- Covers Cellular Bands between 600-6000MHz
- High Efficiency Antenna
- IP67 Rating
- 3 Way Mounting Options
 - Magnetic Mount
 - Wall Mount
 - Desktop Mount
- 2*Low Loss 1m CFD-200 Cables, SMA(M)
- Cable and Connector Customizable
- Enclosure Dimensions: 164*164*36.5mm
- RoHS & Reach Compliant

1. Introduction	3
2. Specifications	4
3. Active Antenna Characteristics	8
4. 4G Antenna Characteristics	13
5. Radiation Patterns	16
6. Mechanical Drawing	33
7. Packaging	34
<hr/>	
8. Application Note	35
<hr/>	
Changelog	38

Taoglas makes no warranties based on the accuracy or completeness of the contents of this document and reserves the right to make changes to specifications and product descriptions at any time without notice. Taoglas reserves all rights to this document and the information contained herein. Reproduction, use or disclosure to third parties without express permission is strictly prohibited.



1. Introduction



Taoglas Gemini LMA101 is a 2* 5G/4G MIMO Antenna for use with all 5G/4G cellular routers and access points worldwide requiring MIMO connectivity. It includes two high-efficiency 5G/4G antennas that operate at all common and 5G/4G bands worldwide from 600MHz to 6000MHz. It has been designed to include 3G and 2G bands, meaning the antenna can also be used for fallback in circumstances where 5G/4G is not available. High isolation and low ECC between the two embedded MIMO antennas prevent self-interference and the low loss CFD-200 cables are used to keep efficiency high over longer cable lengths of up to 5 meters.

This unique antenna offers three mounting options for easy installation. The base features eight super-magnets for easy and secure installation on metal surfaces. The rear of the enclosure features a bracket to enable wall installation, keeping your workstation free from clutter or the antenna can also be placed directly on a flat surface using the stand. The LMA101 can be used both indoors and outdoors as the robust external enclosure is fully IP67 rated.

Typical Applications include:

- HD Real-time Streaming Video over LTE
- Intelligent Transport Systems
- Digital Signage and HD Broadcast Systems
- Wireless 5G/4G MIMO M2M devices with legacy 3G/2G functionality.

Cable length and connector types are customizable. Contact your regional Taoglas sales office for support.

2. Specifications

Electrical

Band	Frequency (MHz)		Efficiency (%)	Average Gain (dB)	Peak Gain (dBi)	Impedance	Max Input Power	Polarization	Radiation Pattern
5G NR/4G Band 71	617~698	MIMO 1	40	-4.9	-0.3	50 Ω	10W	Linear	Omni-Directional
		MIMO 2	39.9	-4.7	-0.2				
4G/3G Band 12,13,14,17,28,29	698~806	MIMO 1	60.9	-2.2	2.1				
		MIMO 2	64	-2	2.3				
4G/3G/NB-IoT/Cat M Band 5,8,18,19,20,26,27	824~960	MIMO 1	34.5	-4.7	-0.2				
		MIMO 2	43	-3.7	0.7				
5G NR/4G Band 21,32,74,75,76	1427~1518	MIMO 1	35.1	-4.5	1.7				
		MIMO 2	25.7	-5.8	1				
4G/3G Band 1,2,3,4,9,23,25,35,39,66	1710~2200	MIMO 1	45	-3.5	1.9				
		MIMO 2	40.3	-4.1	1.5				
4G/3G Band 7,38,41	2490~2690	MIMO 1	42.3	-3.8	1.6				
		MIMO 2	47.8	-3.3	3				
5G NR Band 22,42,48,77,78,79	3300~5000	MIMO 1	18.1	-7.8	-0.6				
		MIMO 2	16.9	-8.5	-1.6				
LTE5200/ Wi-Fi 5800	5150~5925	MIMO 1	25.7	-5.9	-0.9				
		MIMO 2	34.7	-4.6	3.4				

Mechanical

Casing	PCL1250Y
Coaxial Cable	CFD-200
Cable Length	1 Meter Standard, fully customizable
Connector	SMA Male Standard, fully customizable
Weight	400g (Antenna with 1 meter Cable and Stand)
Dimension	164*164*36.5mm
Waterproof Rating	IP67
Magnetic Pull Force	11.24 kgF-cm
Magnetic Dim/Pcs	Ø18*3t N48M/ 8 pcs

Environmental	
Temperature Range	-40°C to 85°C
Humidity	Non-condensing 65°C 95% RH

5G/4G Bands			
Band Number	5G NR / FR1 / LTE / LTE-Advanced / WCDMA / HSPA / HSPA+ / TD-SCDMA / Cat M / NB-IoT		
	Uplink	Downlink	Covered
1	UL: 1920 to 1980	DL: 2110 to 2170	✓
2	UL: 1850 to 1910	DL: 1930 to 1990	✓
3	UL: 1710 to 1785	DL: 1805 to 1880	✓
4	UL: 1710 to 1755	DL: 2110 to 2155	✓
5	UL: 824 to 849	DL: 869 to 894	✓
7	UL: 2500 to 2570	DL: 2620 to 2690	✓
8	UL: 880 to 915	DL: 925 to 960	✓
9	UL: 1749.9 to 1784.9	DL: 1844.9 to 1879.9	✓
11	UL: 1427.9 to 1447.9	DL: 1475.9 to 1495.9	✓
12	UL: 699 to 716	DL: 729 to 746	✓
13	UL: 777 to 787	DL: 746 to 756	✓
14	UL: 788 to 798	DL: 758 to 768	✓
17	UL: 704 to 716	DL: 734 to 746	✓
18	UL: 815 to 830	DL: 860 to 875	✓
19	UL: 830 to 845	DL: 875 to 890	✓
20	UL: 832 to 862	DL: 791 to 821	✓
21	UL: 1447.9 to 1462.9	DL: 1495.9 to 1510.9	✓
22	UL: 3410 to 3490	DL: 3510 to 3590	✓
23	UL: 2000 to 2020	DL: 2180 to 2200	✓
24	UL: 1625.5 to 1660.5	DL: 1525 to 1559	✓
25	UL: 1850 to 1915	DL: 1930 to 1995	✓
26	UL: 814 to 849	DL: 859 to 894	✓
27	UL: 807 to 824	DL: 852 to 869	✓
28	UL: 703 to 748	DL: 758 to 803	✓
29	UL: -	DL: 717 to 728	✓
30	UL: 2305 to 2315	DL: 2350 to 2360	✓
31	UL: 452.5 to 457.5	DL: 462.5 to 467.5	✗
32	UL: -	DL: 1452 - 1496	✓
35		1850 to 1910	✓
38		2570 to 2620	✓
39		1880 to 1920	✓
40		2300 to 2400	✓
41		2496 to 2690	✓
42		3400 to 3600	✗
43		3600 to 3800	✓
48		3550 to 3700	✓
66	UL: 1710-1780	DL: 2110-2200	✓
71		617 to 698	✓
74/75/76		1427 to 1518	✓
77		3300 to 4200	✓
78		3300 to 3800	✗
79		4400 to 5000	✓

3. Antenna Characteristics

3.1 Return Loss

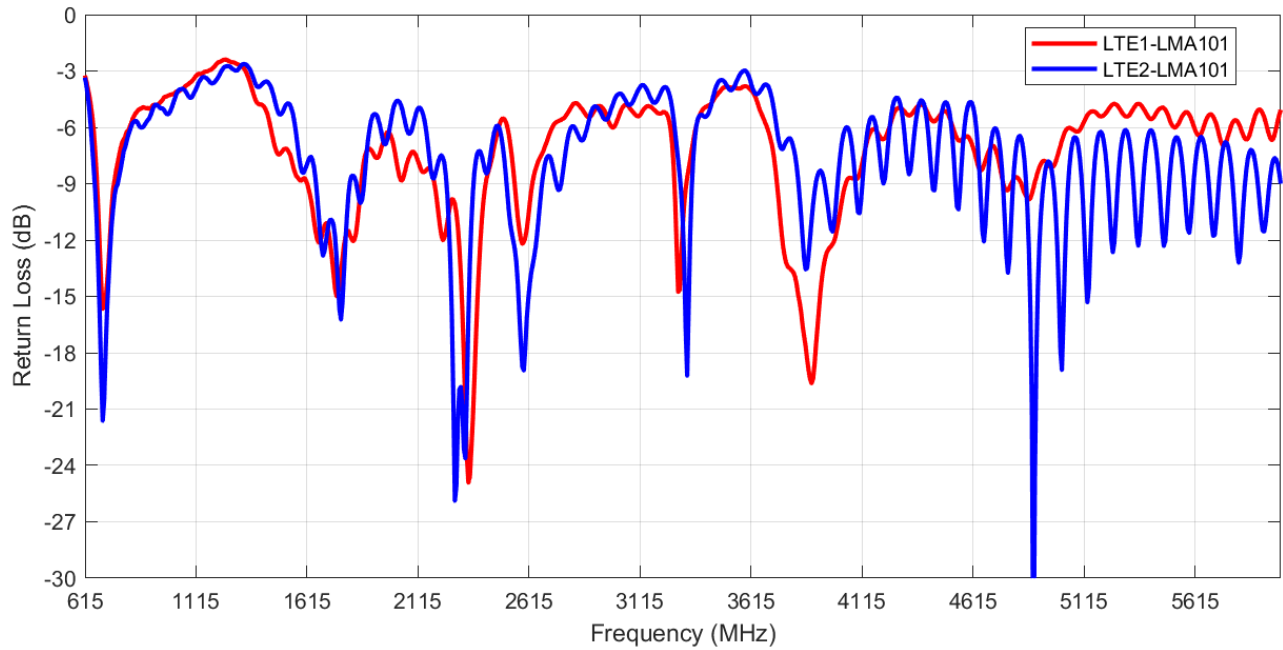

3.2 Efficiency

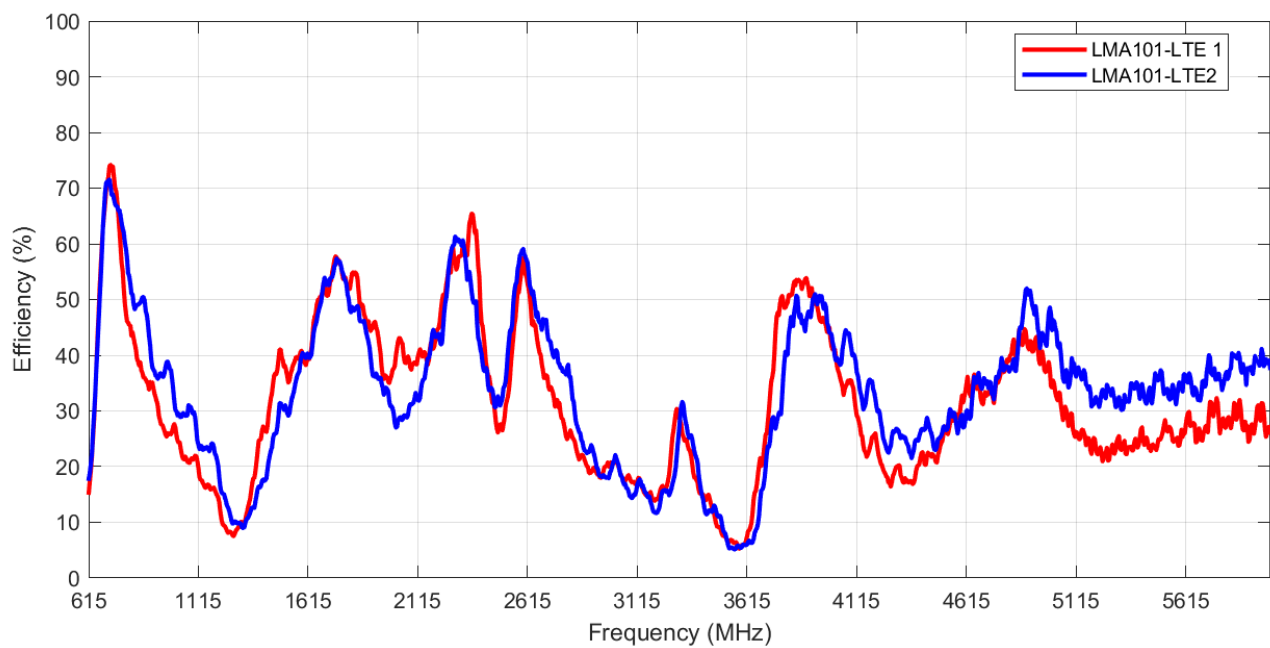

3.3 Peak Gain

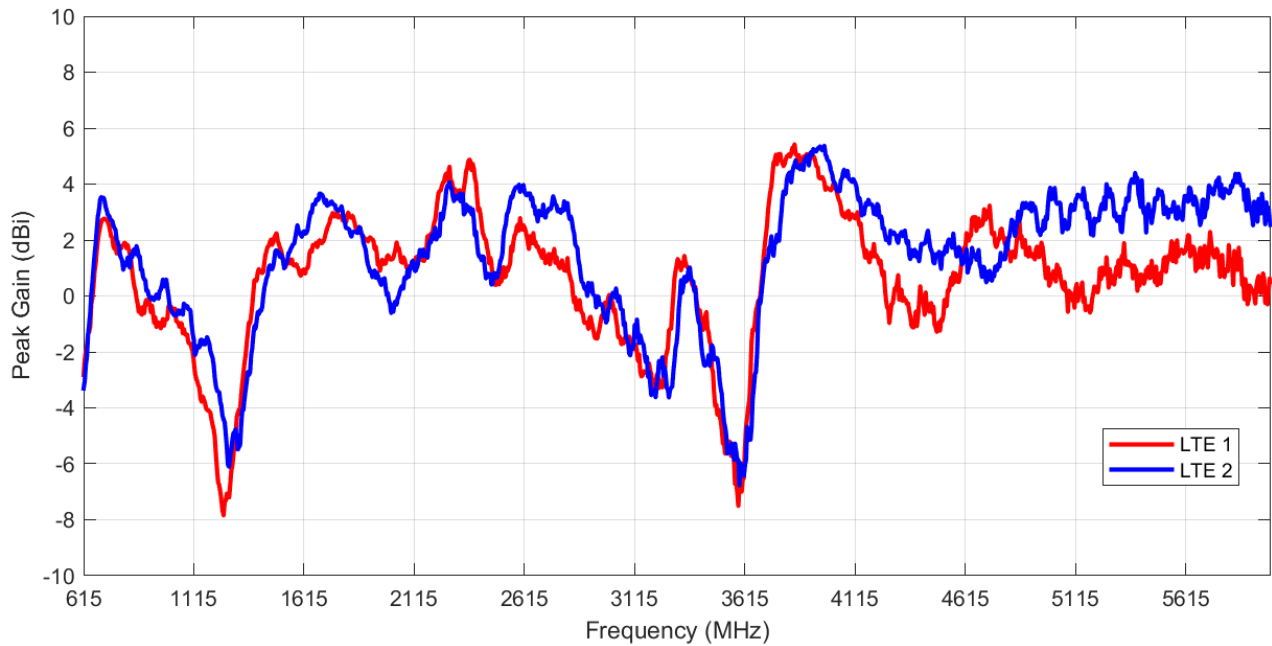

3.4 Average Gain

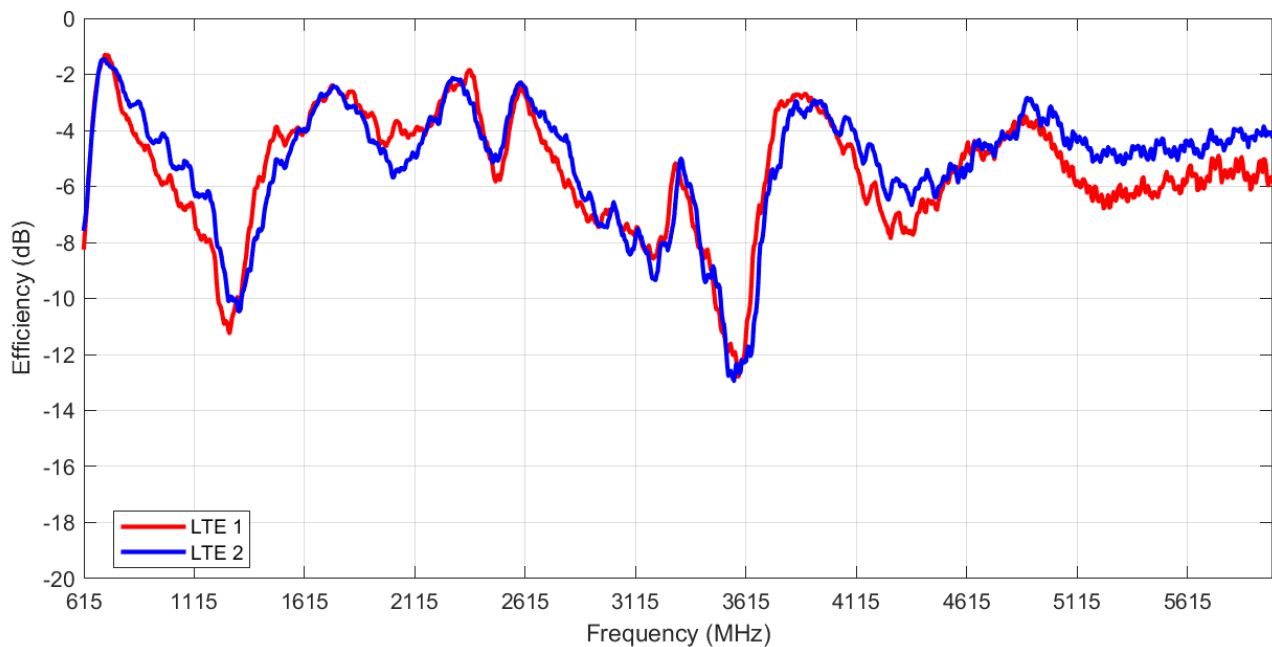

4. Radiation Patterns

4.1 Test Setup



Free space

4.2 4G MIMO 1 - 3D and 2D Radiation Patterns

704MHz

960MHz

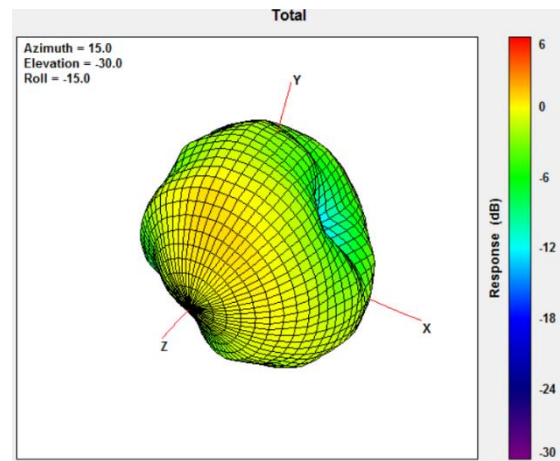
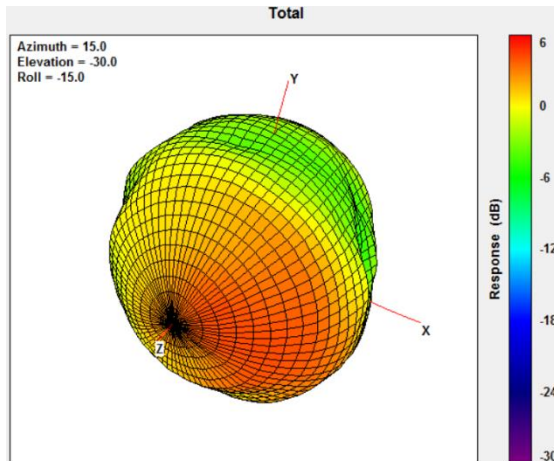

XY Plane

XZ Plane

YZ Plane

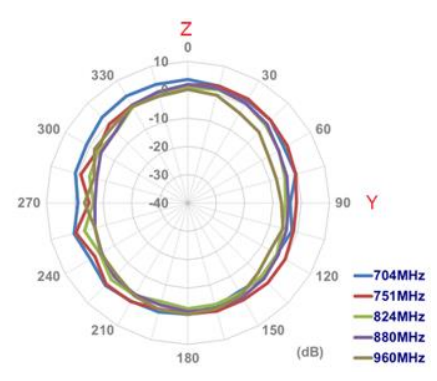
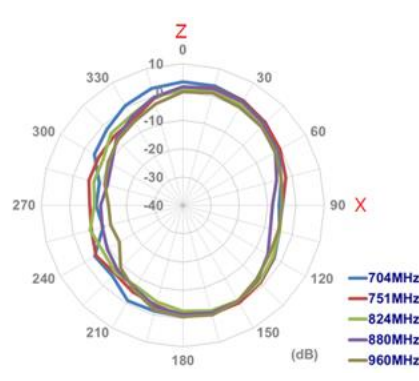
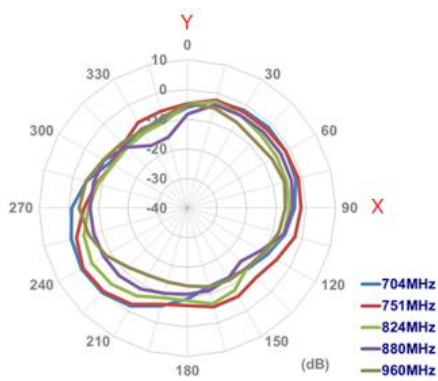

1710MHz **2170MHz**

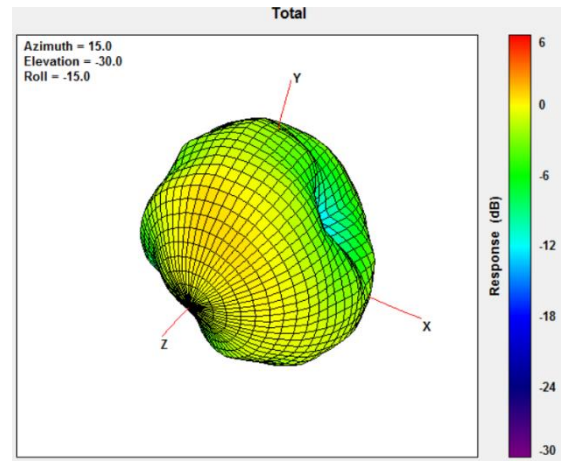
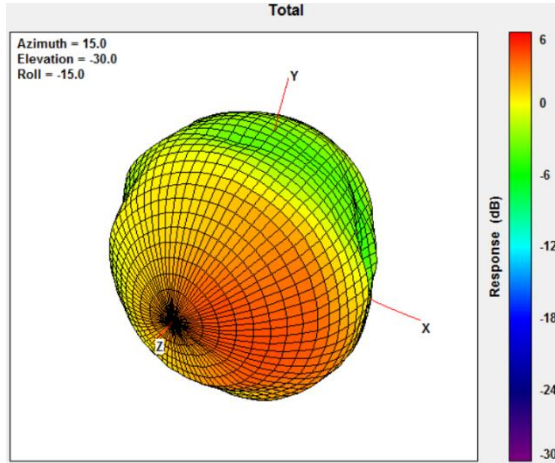

XY Plane

XZ Plane

YZ Plane

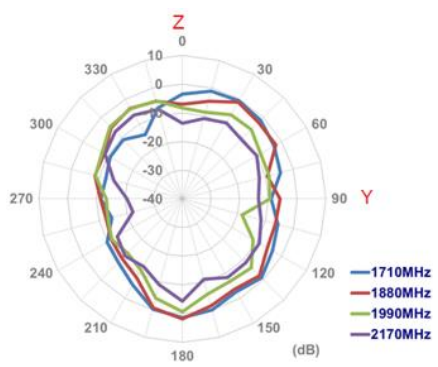
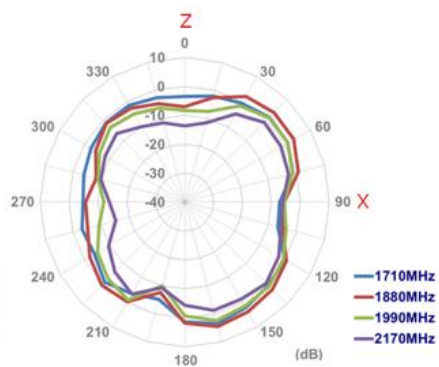
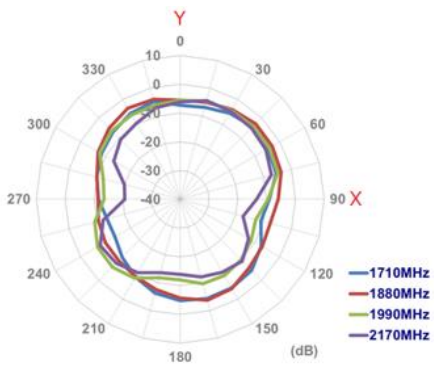

2600MHz

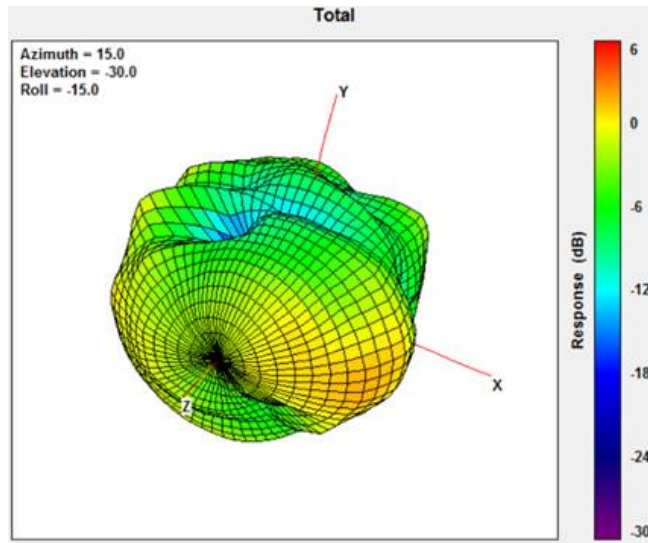

XY Plane

XZ Plane

YZ Plane

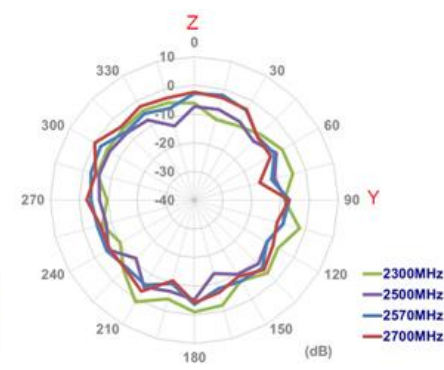
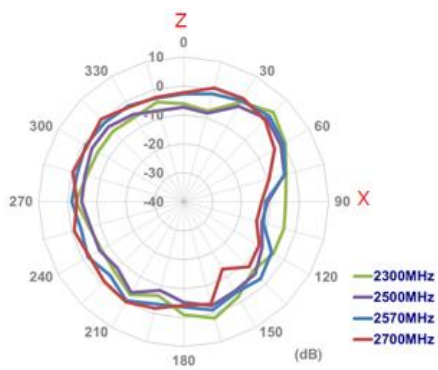
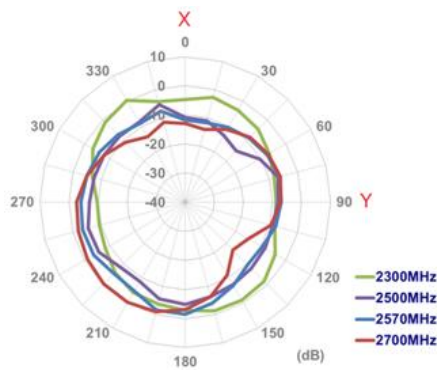

4.3 4G MIMO 2 - 3D and 2D Radiation Patterns

704MHz

960MHz

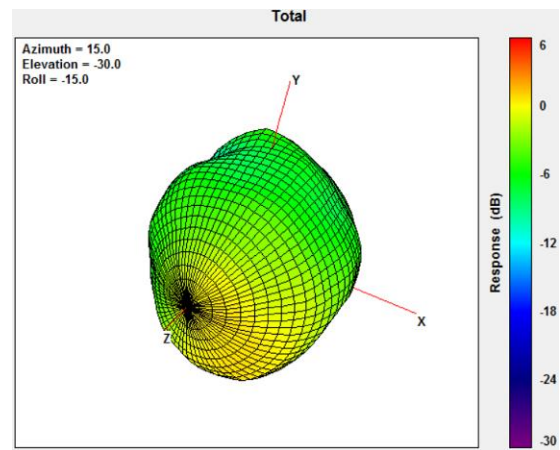
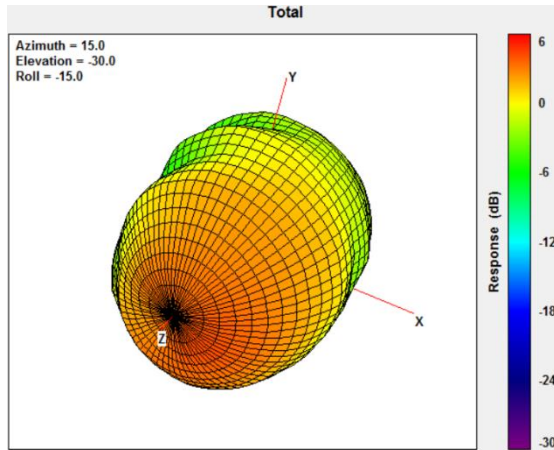

XY Plane

XZ Plane

YZ Plane

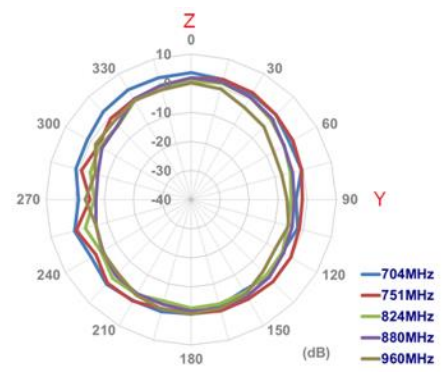
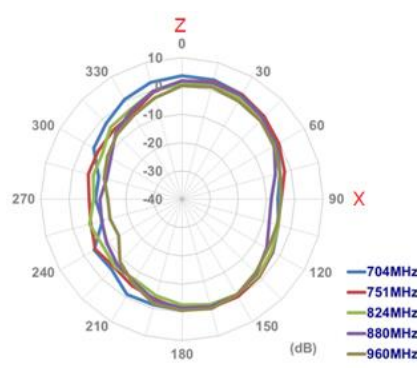
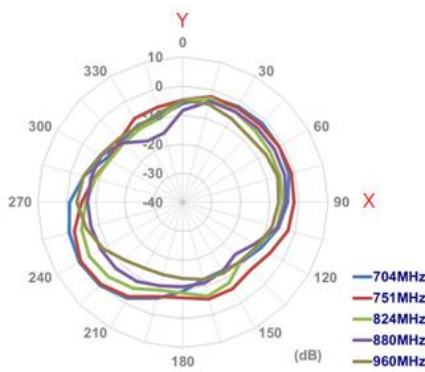

1710MHz

2170MHz

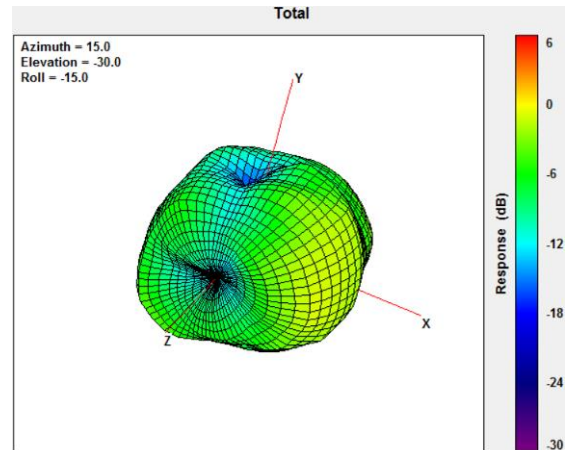
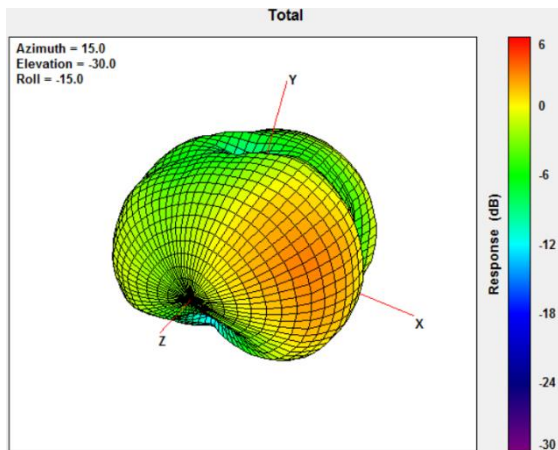

XY Plane

XZ Plane

YZ Plane

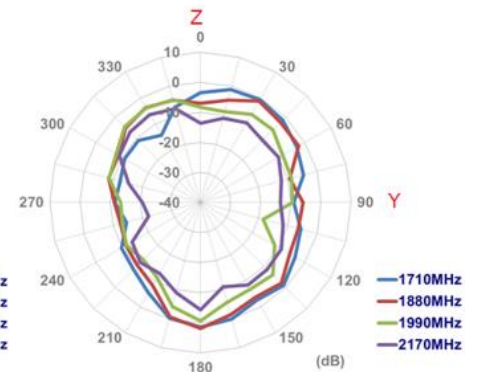
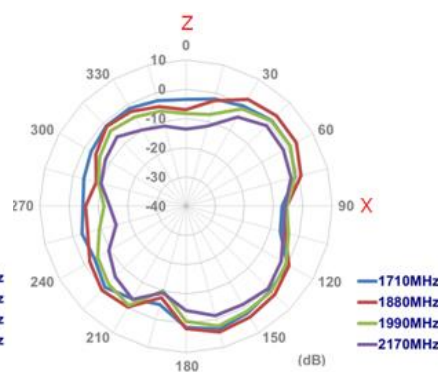
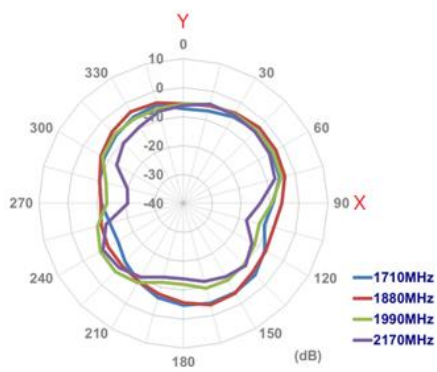

2600MHz

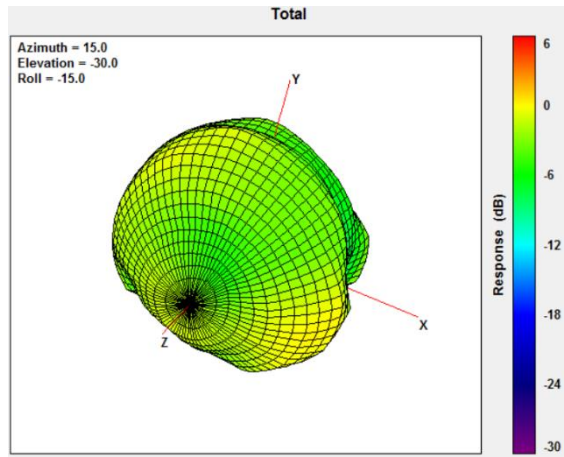

XY Plane

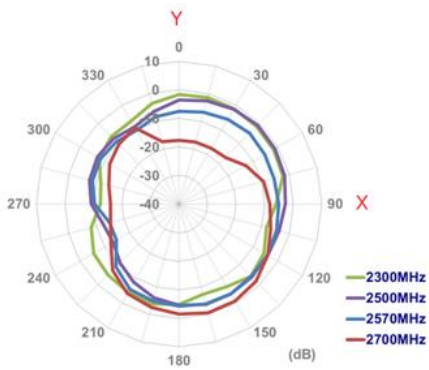

XZ Plane

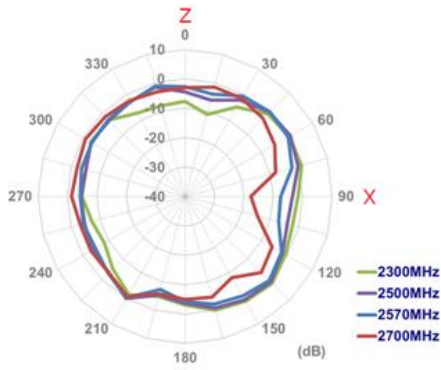

YZ Plane

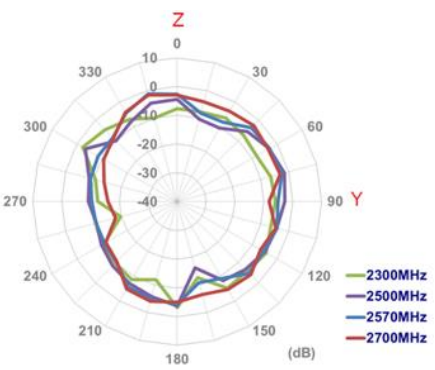

5. Mechanical Drawing (Units: mm)

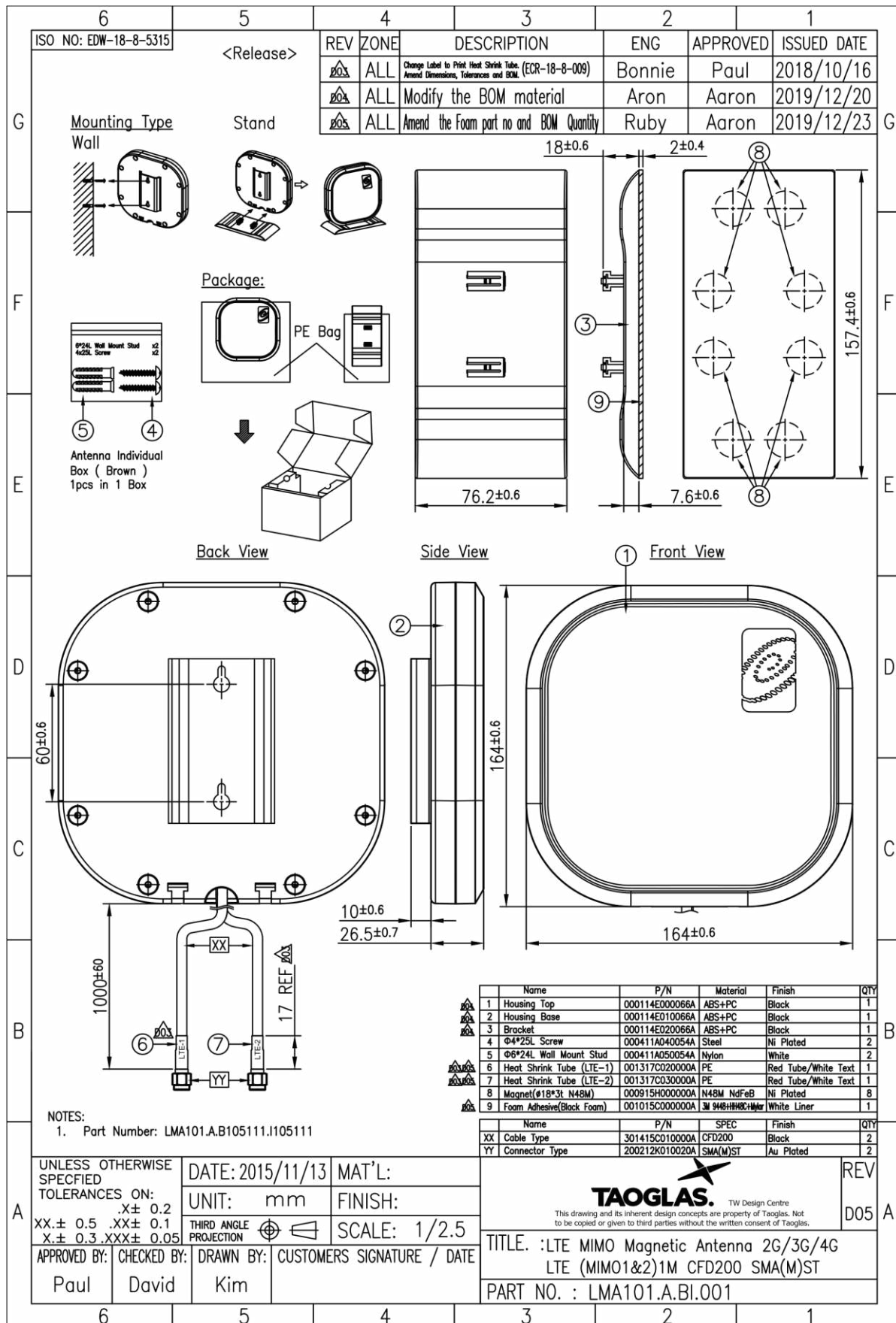

6. Packaging

LMA101.A.BI.001

Packaging Specifications

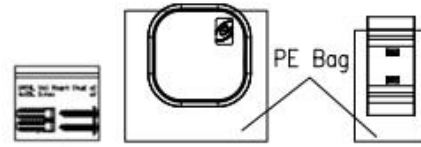

1pc LMA101.A.BI.001 per small box
 Box Dimensions - 235*170*110mm
 Weight - 650g

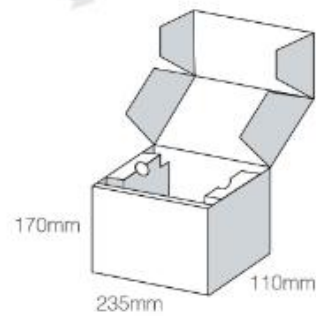

5 small boxes in one carton
 Carton Dimensions - 360*290*260mm
 Weight - 3.8Kg

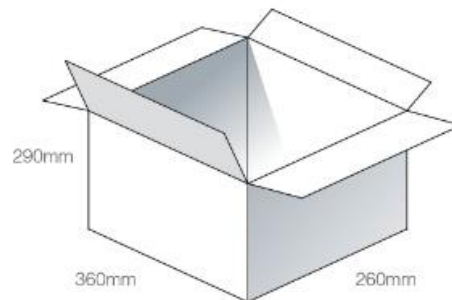

Pallet Dimensions 1100*1100*1290mm
 48 Cartons per Pallet
 12 Cartons per layer
 4 Layers

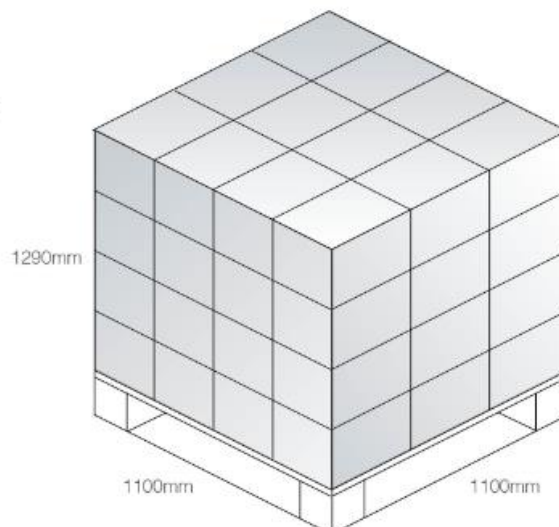

7. Installation

7.1 Package Contents

6*24L
Wall Mount
Stud *2

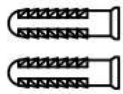

4*25L
Screw*2

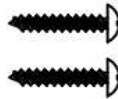

Stand *1

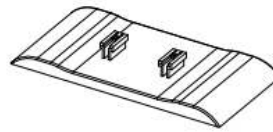

Antenna *1

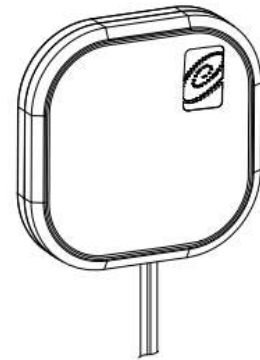

7.2 Desktop Stand/Magnet Mount

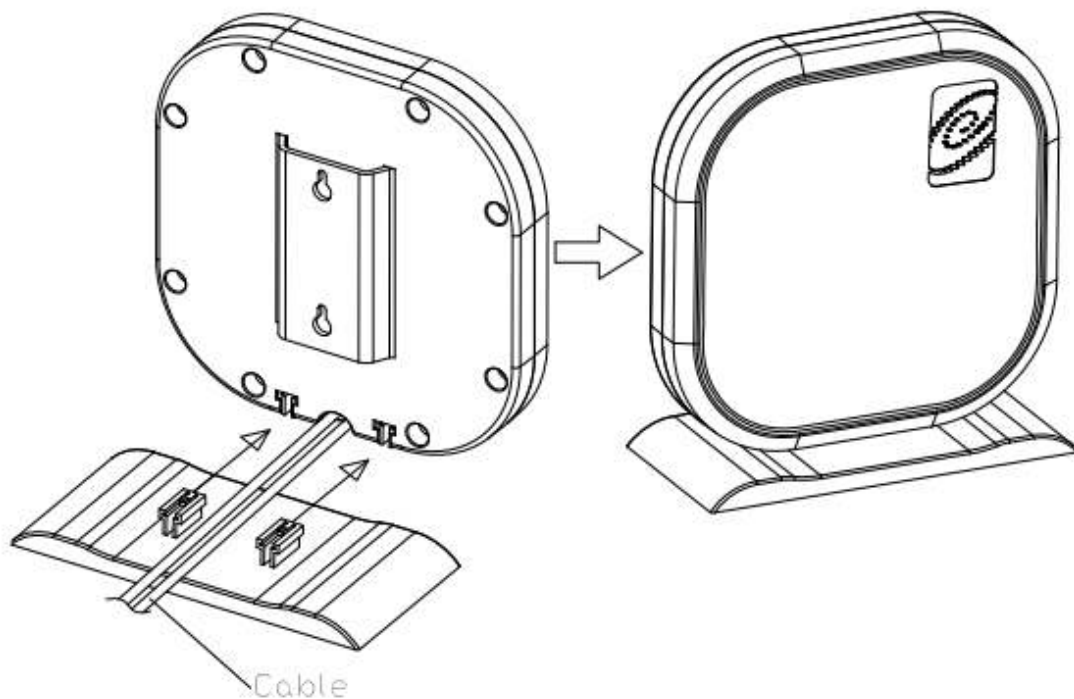

7.3 Wall Mount

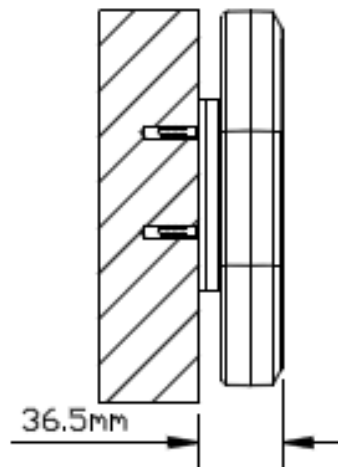
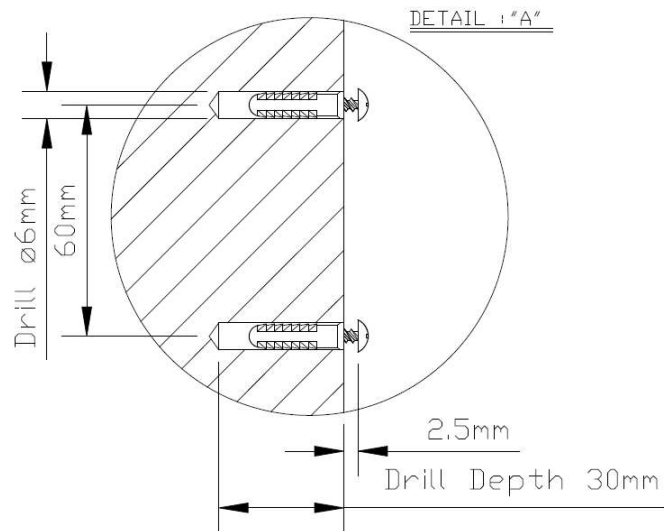
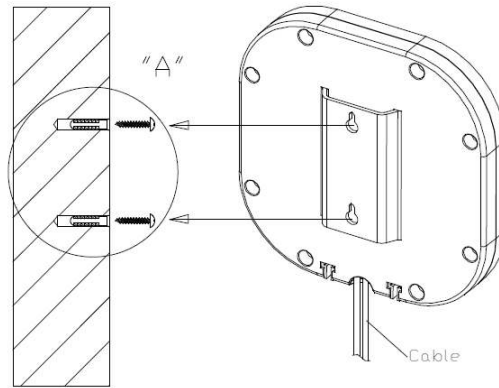

8. Installation

8.1 Testing setup

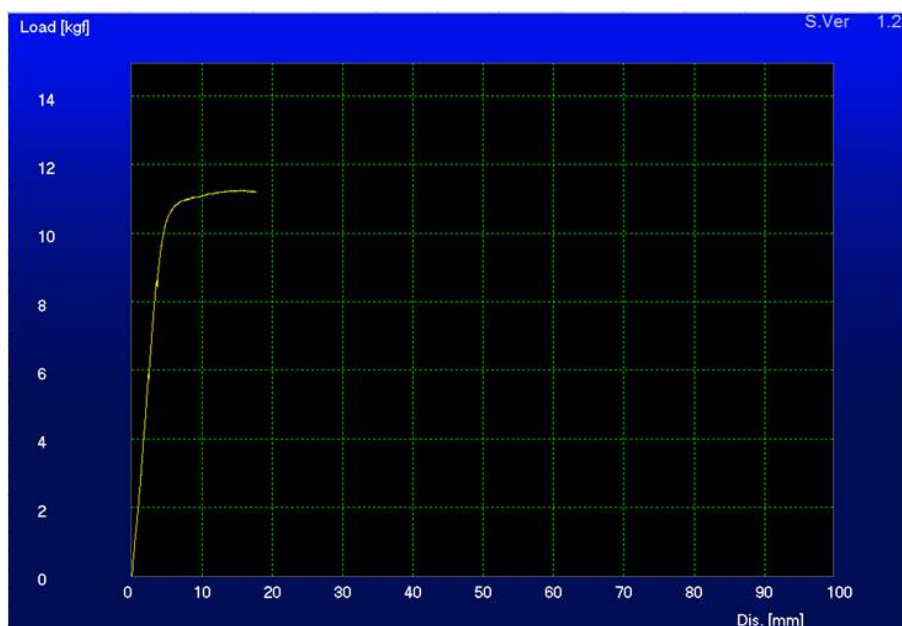
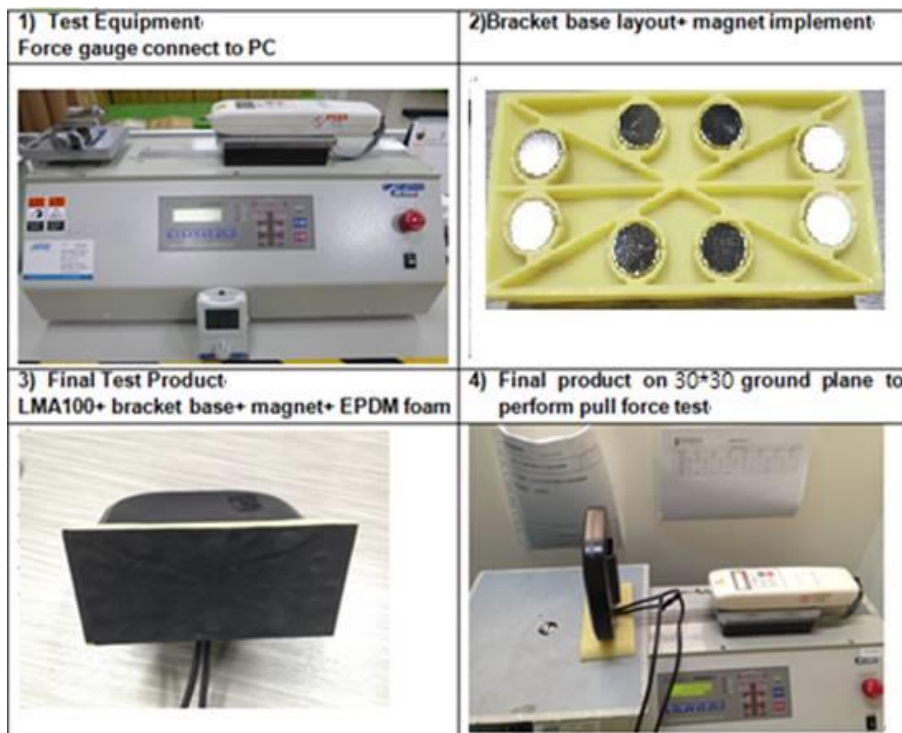

Max Pull Force: 11.24Kgf-cm

Changelog for the datasheet

SPE-17-8-017 – LMA101.A.BI.001

Revision: E (Current Version)

Date:	2023-07-10
Changes:	Update electrical specifications
Changes Made by:	Cesar Sousa

Previous Revisions

Revision: D

Date:	2019-01-02
Changes:	Updated to show 5G data
Changes Made by:	Jack Conroy

Revision: C

Date:	2018-12-20
Changes:	Updated Drawing issues
Changes Made by:	Jack Conroy

Revision: B

Date:	2017-06-15
Changes:	Updated to match PCN
Changes Made by:	Andy Mahoney

Revision: A (Original First Release)

Date:	2017-02-23
Notes:	
Author:	Jack Conroy



TAOGLAS®

www.taoglas.com

