

RM SERIES SHELL SIZE 12 – 31mm CIRCULAR CONNECTORS

Introduction

RM Series are compact, circular connectors HIROSE has developed as the result of many years of research and proven experience to meet the most stringent demands of communication equipment as well as electronic equipment. RM Series is available in 5 shell sizes: 12, 15, 21, 24, and 31. There are also 16 kinds of contacts: 2, 3, 4, 5, 6, 7, 8, 10, 12, 15, 20, 31, 40, and 55 (contacts 2 and 4 are available in two types). And also available water proof type in special series. The lock mechanisms with thread coupling

type, bayonet sleeve type or quick detachable type are easy to use.

Various kinds of accessories are available.

RM Series are miniaturized in size, rugged and excellent in mechanical and electrical performance thus making it possible to meet the most stringent demands of users. Refer to the contact arrangements of RM series connectors on page 60~61.

Main materials (Note that the above may not apply depending on type.)

| Part | Material | Finish |
|----------------|----------------------|---------------|
| Shell | Brass and Zinc alloy | Nickel plated |
| Insulator | Synthetic resin | |
| Male contact | Copper alloy | Silver plated |
| Female contact | Copper alloy | Silver plated |

Ordering Information

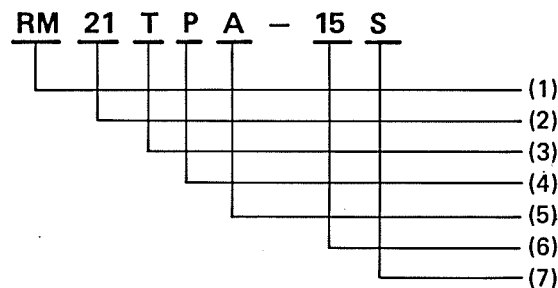

Product identification

- (1) RM: Round Miniature series name
 - (2) 21: The shell size is figured by outer diameter of fitting section of plug and available in 5 types, 12, 15, 21, 24, 31.
 - (3) T: Type of lock mechanism as follows;
 - T: Thread coupling type
 - B: Bayonet sleeve type
 - Q: Quick detachable type
 - (4) P: Type of connector
 - P: Plug
 - R: Receptacle:
 - J: Jack
 - WP: Waterproof
 - WR: Waterproof receptacle
 - P-CP*: Cord clamp for plug
- (* is shown applicable diameter of cable)

- R-C: Cap of receptacle
 - R-F: Square flange for receptacle
 - P-B: Cord bushing
 - (5) A: Shell model change mark
 - Each time the shell undergoes a change in enclosure or the like, it is marked as A, B, D, E.
 - Do not use the letter for C, J, P, R avoiding confusion.
 - (6) 15: Number of pins
 - (7) S: Shape of contact
 - P: Pin
 - S: Socket
- However, connecting method of contact or type shall be classified adding with alphabetical letter.

Standard RM Series

Standard RM series are more compact and higher in performance than our former models. Mechanically stable thanks to its rigid and simple construction. Used widely for all types of equipment, although no special measures are taken for resistance to harsh conditions such as dustproof or waterproof design.

RM12B Connectors

(Bayonet sleeve type)

RM12B connectors (bayonet sleeve type) are provided with a bayonet sleeve locking mechanism, the most compact in the series.

Plug

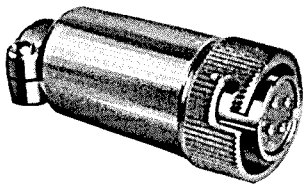

RM12BPG-4S(07)

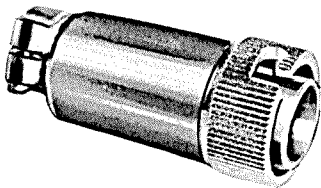

RM12BPG-4PH

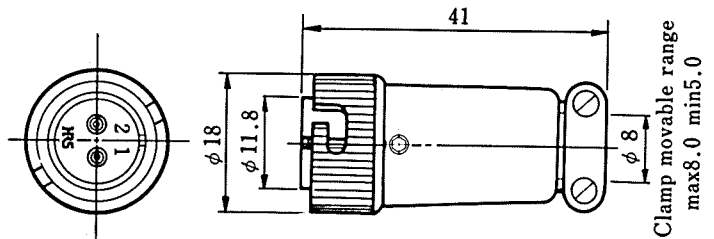

(An example in shape)

| HRS No. | Part No. | No. of pins | HRS No. | Part No. | No. of pins |
|---------------|----------------|-------------|------------|-------------|-------------|
| 109-0567-0-07 | RM12BPG-2S(07) | 2 | 109-0811-9 | RM12BPG-2PH | 2 |
| 109-0568-2-07 | RM12BPG-3S(07) | 3 | 109-0812-1 | RM12BPG-3PH | 3 |
| 109-0569-5-07 | RM12BPG-4S(07) | 4 | 109-0813-4 | RM12BPG-4PH | 4 |
| 109-0570-4-07 | RM12BPG-5S(07) | 5 | 109-0814-7 | RM12BPG-5PH | 5 |
| 109-0571-7-07 | RM12BPG-6S(07) | 6 | 109-0815-0 | RM12BPG-6PH | 6 |
| 109-0616-3-07 | RM12BPG-7S(07) | 7 | 109-0816-2 | RM12BPG-7PH | 7 |

Receptacle

Receptacle(Jam Nut to be fastened)

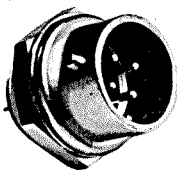

RM12BRD-4PH

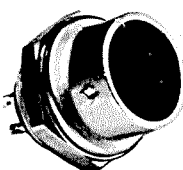

RM12BRD-4S

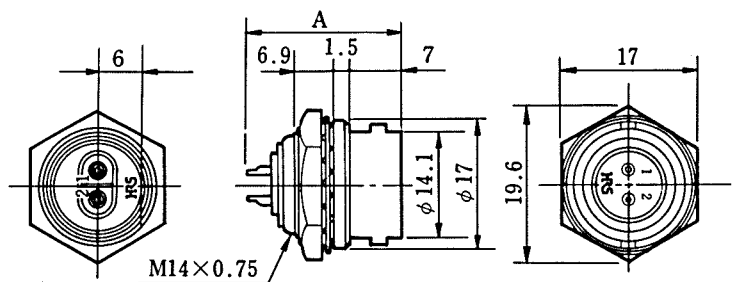

(An example in shape)

| HRS No. | Part No. | No. of pins | A | HRS No. | Part No. | No. of pins | A |
|------------|-------------|-------------|------|------------|------------|-------------|------|
| 109-0823-8 | RM12BRD-2PH | 2 | 20.5 | 109-0609-8 | RM12BRD-2S | 2 | 21.6 |
| 109-0824-0 | RM12BRD-3PH | 3 | 20.5 | 109-0610-7 | RM12BRD-3S | 3 | 21.6 |
| 109-0825-3 | RM12BRD-4PH | 4 | 20.5 | 109-0611-0 | RM12BRD-4S | 4 | 21.6 |
| 109-0826-6 | RM12BRD-5PH | 5 | 20.5 | 109-0612-2 | RM12BRD-5S | 5 | 21.6 |
| 109-0827-9 | RM12BRD-6PH | 6 | 20.5 | 109-0613-5 | RM12BRD-6S | 6 | 21.6 |
| 109-0828-1 | RM12BRD-7PH | 7 | 20.5 | 109-0619-1 | RM12BRD-7S | 7 | 21.6 |

Remark: For mounting holes, see page 60.

Receptacle

Receptacle (square flange) single method

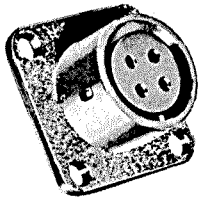

RM12BRB-4S

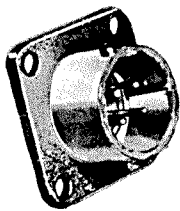
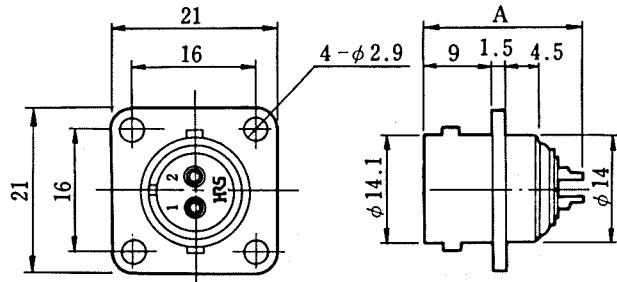

RM12BRB-4PH

(An example in shape)

| HRS No. | Part No. | No. of pins | A | HRS No. | Part No. | No. of pins | A |
|------------|------------|-------------|------|------------|-------------|-------------|------|
| 109-0577-3 | RM12BRB-2S | 2 | 21.6 | 109-0817-5 | RM12BRB-2PH | 2 | 20.5 |
| 109-0578-6 | RM12BRB-3S | 3 | 21.6 | 109-0818-8 | RM12BRB-3PH | 3 | 20.5 |
| 109-0579-9 | RM12BRB-4S | 4 | 21.6 | 109-0819-0 | RM12BRB-4PH | 4 | 20.5 |
| 109-0580-8 | RM12BRB-5S | 5 | 21.6 | 109-0820-0 | RM12BRB-5PH | 5 | 20.5 |
| 109-0581-0 | RM12BRB-6S | 6 | 21.6 | 109-0821-2 | RM12BRB-6PH | 6 | 20.5 |
| 109-0615-0 | RM12BRB-7S | 7 | 21.6 | 109-0822-5 | RM12BRB-7PH | 7 | 20.5 |

- Remarks: 1. For mounting holes, see page 60.
 2. Note that the RM12BRB differs in mounting dimensions from the RM12BR-F.

Jack

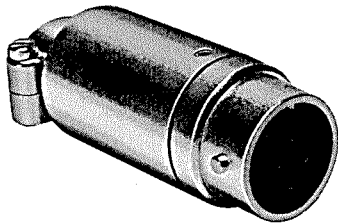

RM12BJB-2S(07)

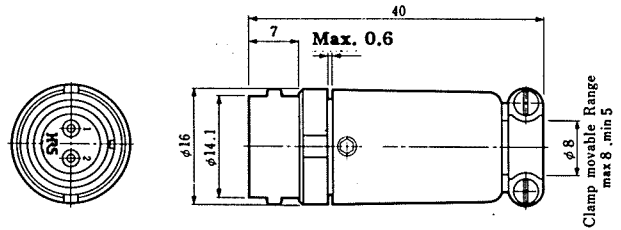

(An example in shape)

| HRS No. | Part No. | No. of pins | HRS No. | Part No. | No. of pins |
|---------------|----------------|-------------|------------|-------------|-------------|
| 109-0638-6-07 | RM12BJB-2S(07) | 2 | 109-0829-4 | RM12BJB-2PH | 2 |
| 109-0639-9-07 | RM12BJB-3S(07) | 3 | 109-0830-3 | RM12BJB-3PH | 3 |
| 109-0640-8-07 | RM12BJB-4S(07) | 4 | 109-0831-6 | RM12BJB-4PH | 4 |
| 109-0641-0-07 | RM12BJB-5S(07) | 5 | 109-0832-9 | RM12BJB-5PH | 5 |
| 109-0642-3-07 | RM12BJB-6S(07) | 6 | 109-0833-1 | RM12BJB-6PH | 6 |
| 109-0643-6-07 | RM12BJB-7S(07) | 7 | 109-0834-4 | RM12BJB-7PH | 7 |

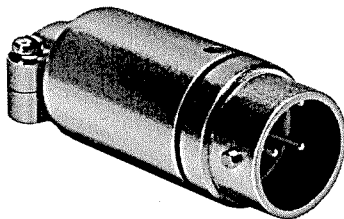

RM12BJB-2PH

Model RM15Q Connectors

(Quick insertion/extraction system)

The model RM15Q connectors have a quick insertion/extraction locking mechanism. Developed by HIROSE, this mechanism allows quicker operation than the locking mechanism of a thread coupling or bayonet coupling.

Plug

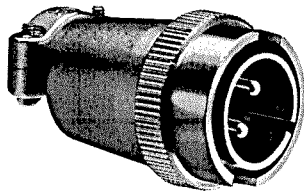

RM15QPS-2PA

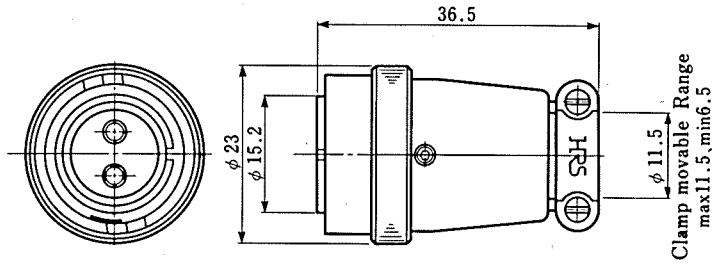

(An example in shape)

| HRS No. | Part No. | No. of pins |
|------------|-------------|-------------|
| 109-0839-8 | RM15QPS-2SA | 2 |
| 109-0840-7 | RM15QPS-4SA | 4 |
| 109-0852-6 | RM15QPS-8S | 8 |
| 109-0853-9 | RM15QPS-10S | 10 |
| 109-0981-9 | RM15QPS-12S | 12 |

| HRS No. | Part No. | No. of pins |
|------------|--------------|-------------|
| 109-0896-1 | RM15QPS-2PA | 2 |
| 109-0897-4 | RM15QPS-4PA | 4 |
| 109-0850-0 | RM15QPS-8PH | 8 |
| 109-0851-3 | RM15QPS-10PH | 10 |
| 109-0980-6 | RM15QPS-12PH | 12 |

Receptacle (Jam Nut to be fastened)

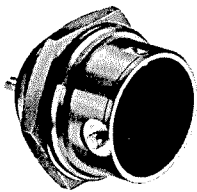

RM15QRD-2SA

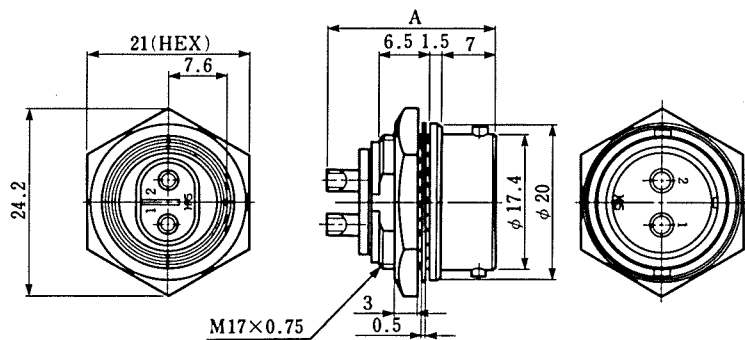

(An example in shape)

| HRS No. | Part No. | No. of pins | A |
|------------|--------------|-------------|------|
| 109-0880-1 | RM15QRD-2PA | 2 | 21 |
| 109-0881-4 | RM15QRD-4PA | 4 | 21 |
| 109-0854-1 | RM15QRD-8PH | 8 | 20.6 |
| 109-0855-4 | RM15QRD-10PH | 10 | 20.6 |
| 109-0982-1 | RM15QRD-12PH | 12 | 20.6 |

| HRS No. | Part No. | No. of pins | A |
|------------|-------------|-------------|------|
| 109-0841-0 | RM15QRD-2SA | 2 | 21.7 |
| 109-0842-2 | RM15QRD-4SA | 4 | 21.7 |
| 109-0864-5 | RM15QRD-8S | 8 | 21.6 |
| 109-0779-8 | RM15QRD-10S | 10 | 21.6 |
| 109-0983-4 | RM15QRD-12S | 12 | 21.6 |

Remark: For mounting holes, see page 60.

RM()T Connectors

(Thread coupling)

Plug

The RM[]T connectors have a screw coupling locking mechanism. Four models of the connectors with shell sizes of 15, 21, 24, and 31 have this locking mechanism. A connector of shell size 15 uses threads of 1 mm pitch. Connectors of shell size 21 and larger use trapezoidal threads for quick operation.

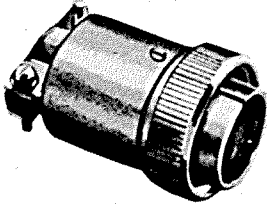

RM15TP-2SA

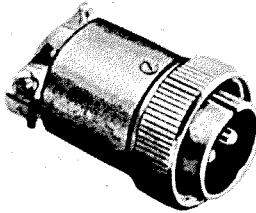

RM15TP-2PA

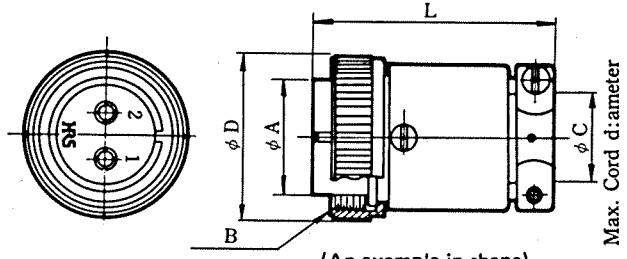

(An example in shape)

| HRS No. | Part No. | No. of pins | phi A | B | phi C | phi C | L |
|------------|-------------|-------------|-------|--------|-------|-------|----|
| 109-0845-0 | RM15TP-2SA | 2 | 15.2 | M19x1 | 11.5 | 21.5 | 34 |
| 109-0898-7 | RM15TP-2PA | 2 | 15.2 | M19x1 | 11.5 | 21.5 | 34 |
| 109-0846-3 | RM15TP-4SA | 4 | 15.2 | M19x1 | 11.5 | 21.5 | 34 |
| 109-0899-0 | RM15TP-4PA | 4 | 15.2 | M19x1 | 11.5 | 21.5 | 34 |
| 109-0053-2 | RM15TP-8S | 8 | 15.2 | M19x1 | 11.5 | 21.5 | 34 |
| 109-0856-7 | RM15TP-8PH | 8 | 15.2 | M19x1 | 11.5 | 21.5 | 34 |
| 109-0055-8 | RM15TP-10S | 10 | 15.2 | M19x1 | 11.5 | 21.5 | 34 |
| 109-0857-0 | RM15TP-10PH | 10 | 15.2 | M19x1 | 11.5 | 21.5 | 34 |
| 109-0321-0 | RM21TP-15S | 15 | 21 | TM25x2 | 15 | 28 | 37 |
| 109-0323-5 | RM21TP-15P | 15 | 21 | TM25x2 | 15 | 28 | 37 |
| 109-0322-2 | RM21TP-20S | 20 | 21 | TM25x2 | 15 | 28 | 37 |
| 109-0324-8 | RM21TP-20P | 20 | 21 | TM25x2 | 15 | 28 | 37 |
| 109-0481-6 | RM24TP-31S | 31 | 24.3 | TM29x2 | 19 | 32 | 41 |
| 109-0482-9 | RM24TP-31P | 31 | 24.3 | TM29x2 | 19 | 32 | 41 |
| 109-0361-4 | RM31TP-40S | 40 | 30.8 | TM35x2 | 26 | 40 | 47 |
| 109-0363-0 | RM31TP-40P | 40 | 30.8 | TM35x2 | 26 | 40 | 47 |
| 109-0362-7 | RM31TP-55S | 55 | 30.8 | TM35x2 | 26 | 40 | 47 |
| 109-0364-2 | RM31TP-55P | 55 | 30.8 | TM35x2 | 26 | 40 | 47 |

Remark: TM25X2 is shown trapezoidal thread of 30°.

Receptacle (Jam Nut to be fastened)

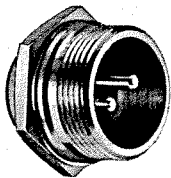

RM15TRH-2PA

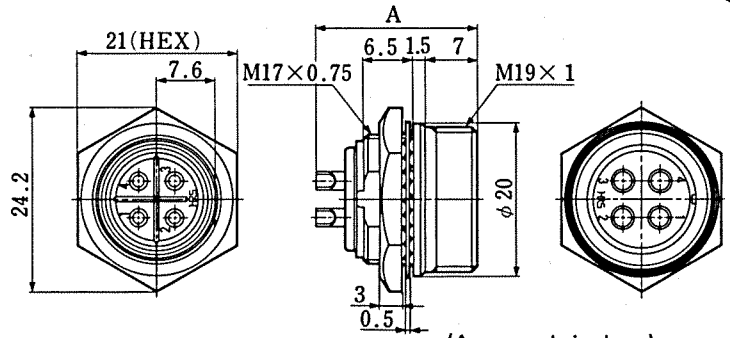

(An example in shape)

| HRS No. | Part No. | No. of pins | A |
|------------|--------------|-------------|------|
| 109-0886-8 | RM15TRH-2PA | 2 | 21 |
| 109-0847-6 | RM15TRH-2SA | 2 | 21.7 |
| 109-0887-0 | RM15TRH-4PA | 4 | 21 |
| 109-0848-9 | RM15TRH-4SA | 4 | 21.7 |
| 109-0858-2 | RM15TRH-8PH | 8 | 20.6 |
| 109-0868-6 | RM15TRH-8S | 8 | 21.6 |
| 109-0859-5 | RM15TRH-10PH | 10 | 20.6 |
| 109-0869-8 | RM15TRH-10S | 10 | 21.6 |

Remark: For mounting holes, see page 60.

Receptacle

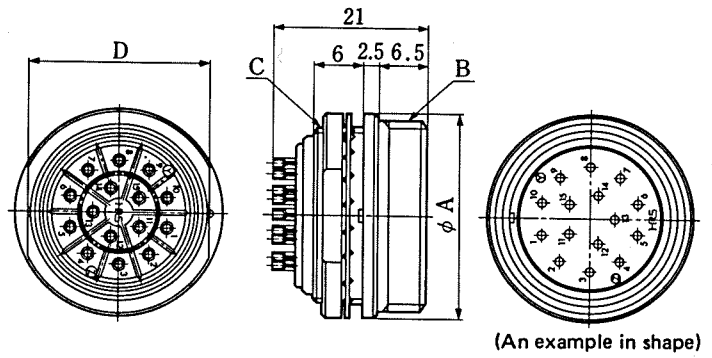
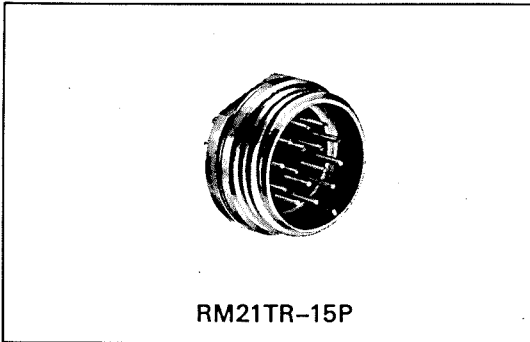

| HRS No. | Part No. | No. of pins | ϕA | B | C | D |
|------------|------------|-------------|----------|--------|----------|------|
| 109-0325-0 | RM21TR-15P | 15 | 27 | TM25x2 | M22x0.75 | 23.5 |
| 109-0327-6 | RM21TR-15S | 15 | 27 | TM25x2 | M22x0.75 | 23.5 |
| 109-0326-3 | RM21TR-20P | 20 | 27 | TM25x2 | M22x0.75 | 23.5 |
| 109-0328-9 | RM21TR-20S | 20 | 27 | TM25x2 | M22x0.75 | 23.5 |
| 109-0483-1 | RM24TR-31P | 31 | 31 | TM29x2 | M26x0.75 | 28 |
| 109-0484-4 | RM24TR-31S | 31 | 31 | TM29x2 | M26x0.75 | 28 |
| 109-0365-5 | RM31TR-40P | 40 | 37 | TM35x2 | M32x0.75 | 34 |
| 109-0367-0 | RM31TR-40S | 40 | 37 | TM35x2 | M32x0.75 | 34 |
| 109-0366-8 | RM31TR-55P | 55 | 37 | TM35x2 | M32x0.75 | 34 |
| 109-0368-3 | RM31TR-55S | 55 | 37 | TM35x2 | M32x0.75 | 34 |

Remarks: 1. TM25X2 is shown trapezoidal thread of 30°.
2. For mounting holes, see page 60.

Tool

Hexagon Wrench Screwdriver

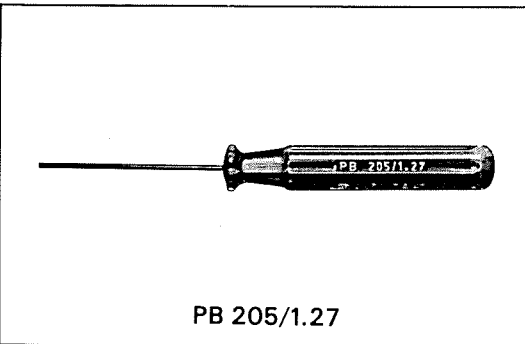

| HRS No. | Part No. | Remark |
|------------|------------|--------|
| 150-0066-3 | PB205/1.27 | |

RM15T(D Type) connectors

The RM15T (model D) connectors are designed for high grade of commercial applications such as VTR. These connectors boast a highly refined design. Since the model D uses locking threads of 30° trapezoidal threads, it is incompatible with the RM15T connectors.

Plug

(Solder Type)

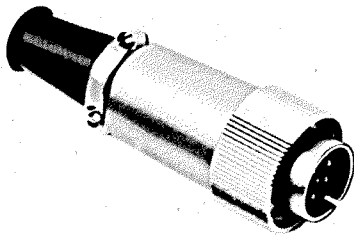

RM15TPD-10P

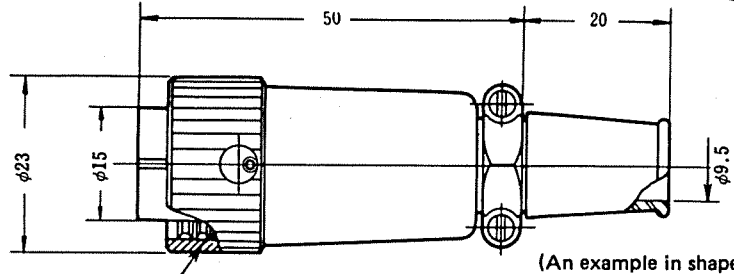

(An example in shape)

| HRS No. | Part No. | No. of pins |
|------------|-------------|-------------|
| 109-0686-9 | RM15TPD-10S | 10 |
| 109-0601-6 | RM15TPD-10P | 10 |
| 109-0660-5 | RM15TPD-12P | 12 |
| 109-0661-8 | RM15TPD-12S | 12 |

Jack

(Solder Type)

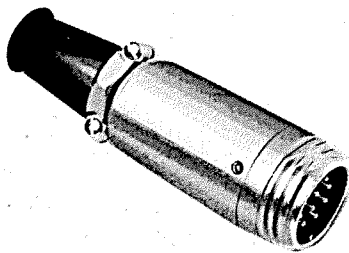

RM15TJD-10P

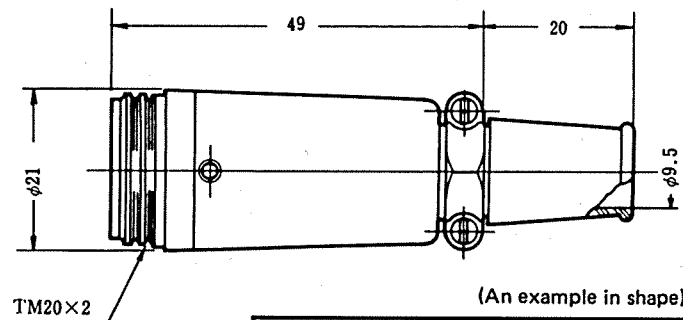

(An example in shape)

| HRS No. | Part No. | No. of pins |
|------------|-------------|-------------|
| 109-0706-4 | RM15TJD-10P | 10 |
| 109-0603-1 | RM15TJD-10S | 10 |
| 109-0665-9 | RM15TJD-12S | 12 |

Receptacle

(Solder Type)

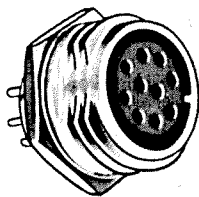

RM15TRD-10S

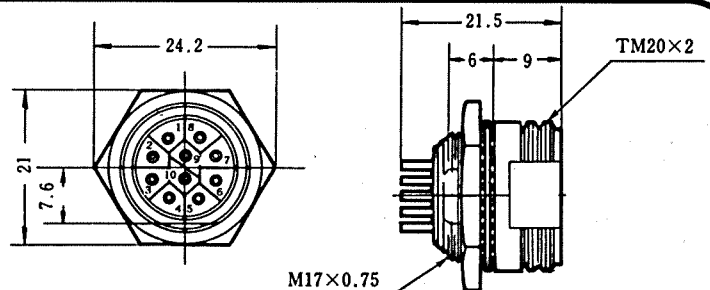

(An example in shape)

| HRS No. | Part No. | No. of pins |
|------------|-------------|-------------|
| 109-0687-1 | RM15TRD-10P | 10 |
| 109-0602-9 | RM15TRD-10S | 10 |
| 109-0662-0 | RM15TRD-12P | 12 |
| 109-0663-3 | RM15TRD-12S | 12 |

Remark: For mounting holes, see page 60.

Plug

(Crimp Type)

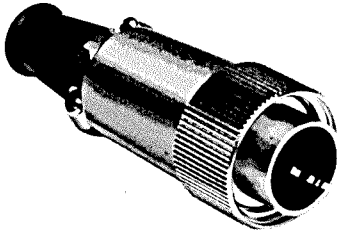

RM15TPD-10PC

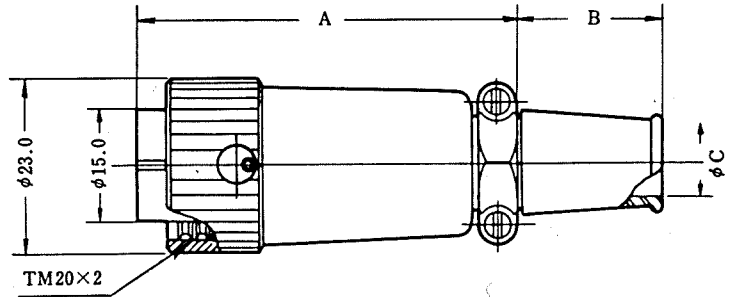

(An example in shape)

| HRS No. | Part No. | No. of pins | A | B | φC |
|------------|--------------|-------------|----|----|-----|
| 109-0677-8 | RM15TPD-10PC | 10 | 50 | 20 | 9.5 |
| 109-0712-7 | RM15TPN-10PC | 10 | 40 | 15 | 8 |

Receptacle

(Crimp Type)

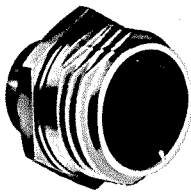

RM15TRD-10SC

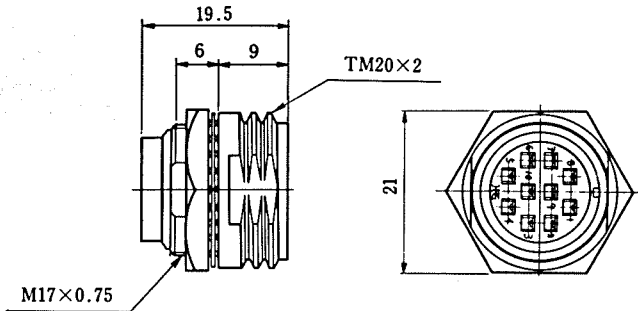

| HRS No. | Part No. | No. of pins |
|------------|--------------|-------------|
| 109-0676-5 | RM15TRD-10SC | 10 |

Remark: For mounting holes, see page 60.

Receptacle

(Dip Type)

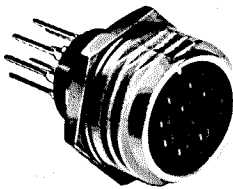

RM15TRD-10SB

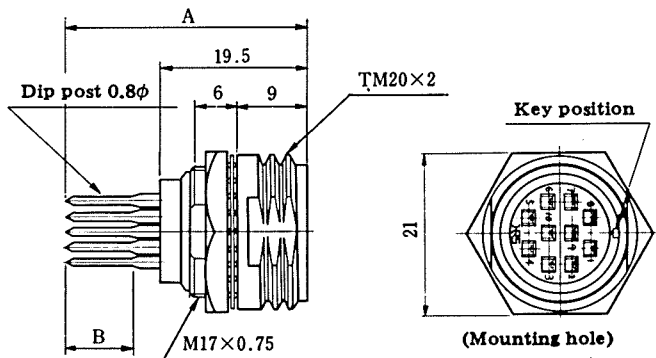

(An example in shape)

| HRS No. | Part No. | No. of pins | A | B |
|------------|--------------|-------------|------|-----|
| 109-0710-1 | RM15TRD-10SB | 10 | 32.3 | 8.3 |
| 109-0722-0 | RM15TRD-10SD | 10 | 27.8 | 3.8 |

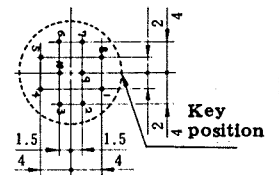

Remark: For mounting holes, see page 60.

■ Contact

Pin contact

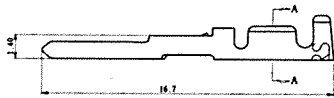

Fig-1

SectionA—A

| Type | HRS No. | Part No. | B | C | Applicable wire |
|---------------|------------|-----------|------|-----|-----------------|
| Loose contact | 109-0668-7 | RM-PC-112 | 1.6 | 2.0 | AWG#20~#24 |
| | 109-0672-4 | RM-PC-122 | 1.45 | 1.5 | AWG#24~#28 |
| Chain contact | 109-0670-9 | RM-PC-212 | 1.6 | 2.0 | AWG#20~#24 |
| | 109-0674-0 | RM-PC-222 | 1.45 | 1.5 | AWG#24~#28 |

Socket contact

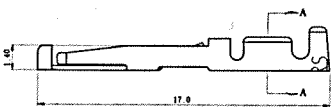

Fig-2

SectionA—A

| Type | HRS No. | Part No. | B | C | Applicable wire |
|---------------|------------|-----------|------|-----|-----------------|
| Loose contact | 109-0669-0 | RM-SC-112 | 1.6 | 2.0 | AWG#20~#24 |
| | 109-0673-7 | RM-SC-122 | 1.45 | 1.5 | AWG#24~#28 |
| Chain contact | 109-0671-1 | RM-SC-212 | 1.6 | 2.0 | AWG#20~#24 |
| | 109-0675-2 | RM-SC-222 | 1.45 | 1.5 | AWG#24~#28 |

Note: Loose-piece pins are available in pack.
 Each pack contains 100 pieces.
 Reel pins are available, one reel contains 8,000 pieces.

◆ Tools

| Type | Item | HRS No. | Part No. | Applicable terminal | Applicable wire |
|------------|---------------------------------|------------|------------|---------------------|-----------------|
| Manual | Manual crimping tool | 150-0006-1 | RM-TC-11 | RM-PC-112 | AWG#20~#24 |
| | | | | RM-SC-112 | |
| | 150-0007-4 | RM-TC-12 | RM-PC-122 | AWG#24~#28 | |
| | | | RM-SC-122 | | |
| Automatic | Automatic crimping machine body | 901-0005-4 | CM-105 | — | — |
| | Applicator | 901-2017-4 | AP105-RM-1 | RM-PC-212 | AWG#20~#24 |
| | | | | RM-SC-212 | |
| | | 901-2018-7 | AP105-RM-2 | RM-PC-222 | AWG#24~#28 |
| | | | | RM-SC-222 | |
| Extraction | 150-0008-7 | RM-TP | — | — | |

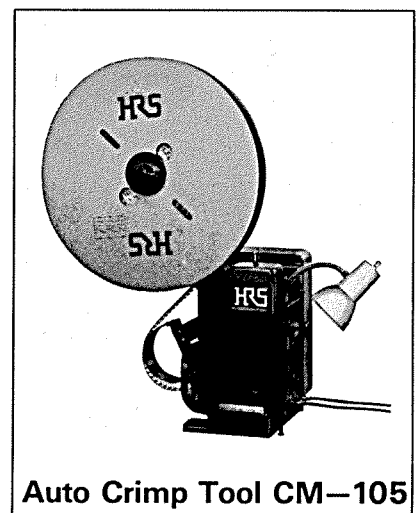

Auto Crimp Tool CM-105



Hand Crimp Tool



Extraction Tool

Waterproof RM Series

The Waterproof RM Series has been developed by redesigning the standard RM Series, but maintaining the same electrical specifications as the standard RM Series.

Model RM12WB Connectors

The RM12B is designed to be watertight for 48 hours at 0.5 M under water, and the RM15T or above is designed to be watertight for 48 hours at 1.0 M under water.

Plug

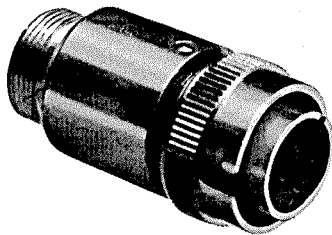

RM12WBP-4S

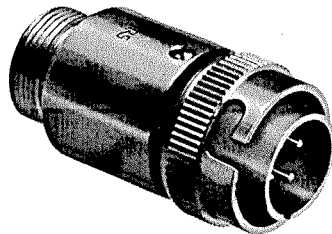

RM12WBP-4P

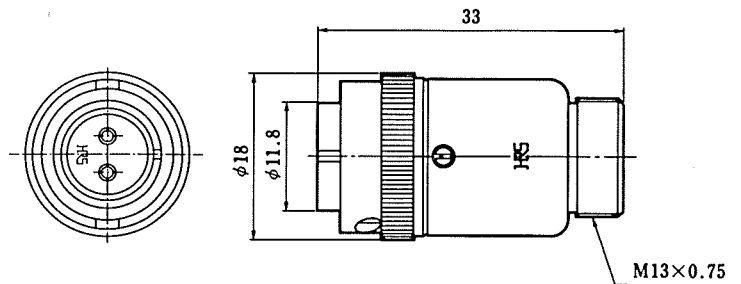

(An example in shape)

| HRS No. | Part No. | No. of pins | HRS No. | Part No. | No. of pins |
|------------|------------|-------------|------------|------------|-------------|
| 109-1141-3 | RM12WBP-2S | 2 | 109-1146-7 | RM12WBP-2P | 2 |
| 109-1142-6 | RM12WBP-3S | 3 | 109-1147-0 | RM12WBP-3P | 3 |
| 109-1143-9 | RM12WBP-4S | 4 | 109-1148-2 | RM12WBP-4P | 4 |
| 109-1144-1 | RM12WBP-5S | 5 | 109-1149-5 | RM12WBP-5P | 5 |
| 109-1145-4 | RM12WBP-6S | 6 | 109-1150-4 | RM12WBP-6P | 6 |

Note 1: Be sure to use plugs in combination with code clamps.

Receptacle



RM12WBR-4P

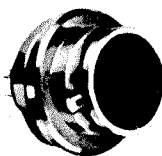

RM12WBR-4S

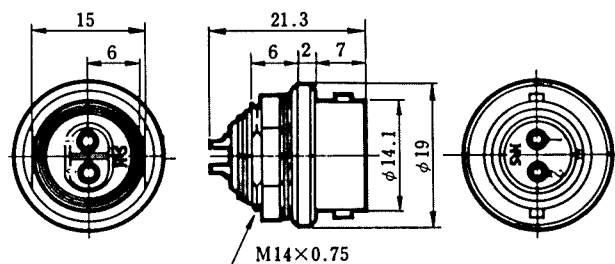

(An example in shape)

| HRS No. | Part No. | No. of pins | HRS No. | Part No. | No. of pins |
|------------|------------|-------------|------------|------------|-------------|
| 109-1021-1 | RM12WBR-2P | 2 | 109-1026-5 | RM12WBR-2S | 2 |
| 109-1022-4 | RM12WBR-3P | 3 | 109-1027-8 | RM12WBR-3S | 3 |
| 109-1023-7 | RM12WBR-4P | 4 | 109-1028-0 | RM12WBR-4S | 4 |
| 109-1024-0 | RM12WBR-5P | 5 | 109-1029-3 | RM12WBR-5S | 5 |
| 109-1025-2 | RM12WBR-6P | 6 | 109-1030-2 | RM12WBR-6S | 6 |

Remark: For mounting holes, see page 60.

Cord Clamp

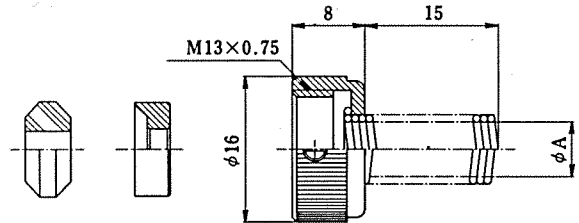
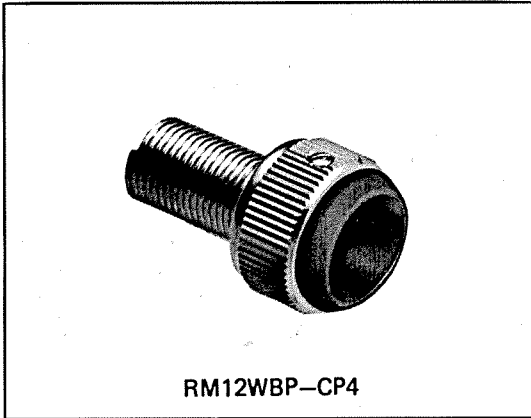

(An example in shape)

| HRS No. | Part No. | φA | Cable dia. |
|------------|-------------|-----|------------|
| 109-1151-7 | RM12WBP-CP4 | 5.5 | φ4 |
| 109-1152-0 | RM12WBP-CP5 | 5.5 | φ5 |
| 109-1153-2 | RM12WBP-CP6 | 7.5 | φ6 |
| 109-1154-5 | RM12WBP-CP7 | 7.5 | φ7 |

Note: Carefully choose the applicable cable because clamping force and waterproofness differ according to the type.

RM()WT type connector

Plug

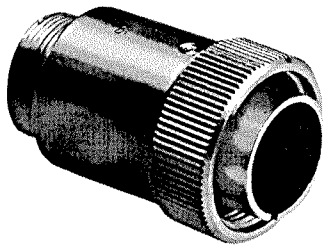

RM15WTP-10S

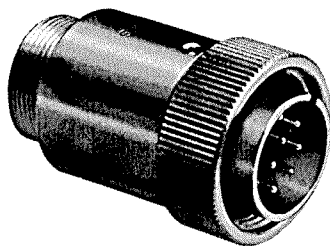

RM15WTP-10P

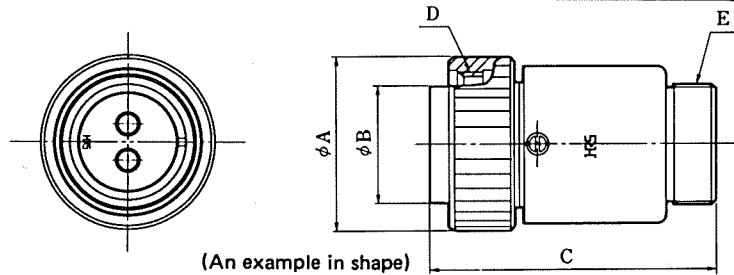

| HRS No. | Part No. | No. of pin | φ A | φ B | C | D | E |
|------------|-------------|------------|-----|------|------|--------|----------|
| 109-1241-8 | RM15WTP-2S | 2 | 23 | 15.2 | 36.8 | M19×1 | M16×0.75 |
| 109-1242-0 | RM15WTP-4S | 4 | 23 | 15.2 | 36.8 | M19×1 | M16×0.75 |
| 109-1243-3 | RM15WTP-8S | 8 | 23 | 15.2 | 36.8 | M19×1 | M16×0.75 |
| 109-1244-6 | RM15WTP-10S | 10 | 23 | 15.2 | 36.8 | M19×1 | M16×0.75 |
| 109-1262-8 | RM15WTP-12S | 12 | 23 | 15.2 | 36.8 | M19×1 | M16×0.75 |
| 109-1245-9 | RM15WTP-2P | 2 | 23 | 15.2 | 36.8 | M19×1 | M16×0.75 |
| 109-1246-1 | RM15WTP-4P | 4 | 23 | 15.2 | 36.8 | M19×1 | M16×0.75 |
| 109-1247-4 | RM15WTP-8P | 8 | 23 | 15.2 | 36.8 | M19×1 | M16×0.75 |
| 109-1248-7 | RM15WTP-10P | 10 | 23 | 15.2 | 36.8 | M19×1 | M16×0.75 |
| 109-1257-8 | RM15WTP-12P | 12 | 23 | 15.2 | 36.8 | M19×1 | M16×0.75 |
| 109-1401-2 | RM21WTP-15S | 15 | 32 | 21 | 37.5 | TM25×2 | M20×0.75 |
| 109-1402-5 | RM21WTP-20S | 20 | 32 | 21 | 37.5 | TM25×2 | M20×0.75 |
| 109-1403-8 | RM21WTP-15P | 15 | 32 | 21 | 37.5 | TM25×2 | M20×0.75 |
| 109-1404-0 | RM21WTP-20P | 20 | 32 | 21 | 37.5 | TM25×2 | M20×0.75 |
| 109-1491-5 | RM24WTP-31S | 31 | 36 | 24.3 | 44 | TM29×2 | M24×0.75 |
| 109-1492-8 | RM24WTP-31P | 31 | 36 | 24.3 | 44 | TM29×2 | M24×0.75 |
| 109-1571-2 | RM31WTP-40S | 40 | 42 | 30.8 | 52 | TM35×2 | M28×0.75 |
| 109-1572-5 | RM31WTP-55S | 55 | 42 | 30.8 | 52 | TM35×2 | M28×0.75 |
| 109-1573-8 | RM31WTP-40P | 40 | 42 | 30.8 | 52 | TM35×2 | M28×0.75 |
| 109-1574-0 | RM31WTP-55P | 55 | 42 | 30.8 | 52 | TM35×2 | M28×0.75 |

Note 1) Be sure to use plugs in combination with code clamps.

Receptacle

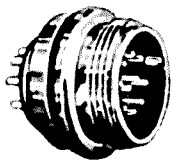

RM15WTR-10P

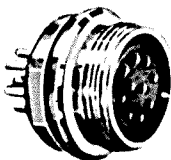

RM15WTR-10S

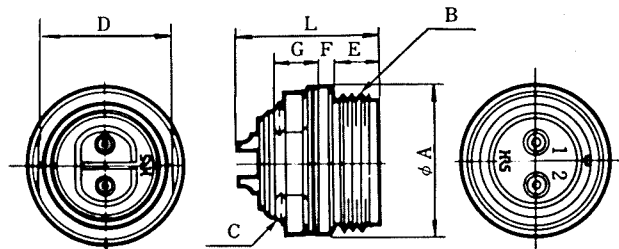

| HRS No. | Part No. | No. of pin | φ A | B | C | D | E | F | G | L |
|------------|-------------|------------|-----|--------|----------|------|-----|-----|---|------|
| 109-1309-0 | RM15WTR-2P | 2 | 22 | M19×1 | M17×0.75 | 18 | 7 | 2 | 6 | 21.0 |
| 109-1316-5 | RM15WTR-2S | 2 | 22 | M19×1 | M17×0.75 | 18 | 7 | 2 | 6 | 21.5 |
| 109-1311-1 | RM15WTR-4P | 4 | 22 | M19×1 | M17×0.75 | 18 | 7 | 2 | 6 | 21.0 |
| 109-1318-0 | RM15WTR-4S | 4 | 22 | M19×1 | M17×0.75 | 18 | 7 | 2 | 6 | 21.5 |
| 109-1313-7 | RM15WTR-8P | 8 | 22 | M19×1 | M17×0.75 | 18 | 7 | 2 | 6 | 20.5 |
| 109-1320-2 | RM15WTR-8S | 8 | 22 | M19×1 | M17×0.75 | 18 | 7 | 2 | 6 | 21.5 |
| 109-1315-2 | RM15WTR-10P | 10 | 22 | M19×1 | M17×0.75 | 18 | 7 | 2 | 6 | 20.5 |
| 109-1322-8 | RM15WTR-10S | 10 | 22 | M19×1 | M17×0.75 | 18 | 7 | 2 | 6 | 21.5 |
| 109-1261-5 | RM15WTR-12P | 12 | 22 | M19×1 | M17×0.75 | 18 | 7 | 2 | 6 | 21.0 |
| 109-1260-2 | RM15WTR-12S | 12 | 22 | M19×1 | M17×0.75 | 18 | 7 | 2 | 6 | 21.5 |
| 109-1445-8 | RM21WTR-15P | 15 | 31 | TM25×2 | M22×0.75 | 23.5 | 6.5 | 2.5 | 6 | 21.0 |
| 109-1447-3 | RM21WTR-15S | 15 | 31 | TM25×2 | M22×0.75 | 23.5 | 6.5 | 2.5 | 6 | 21.0 |
| 109-1446-0 | RM21WTR-20P | 20 | 31 | TM25×2 | M22×0.75 | 23.5 | 6.5 | 2.5 | 6 | 21.0 |
| 109-1448-6 | RM21WTR-20S | 20 | 31 | TM25×2 | M22×0.75 | 23.5 | 6.5 | 2.5 | 6 | 21.0 |
| 109-1483-7 | RM24WTR-31P | 31 | 35 | TM29×2 | M26×0.75 | 28 | 6.5 | 2.5 | 6 | 21.0 |
| 109-1484-0 | RM24WTR-31S | 31 | 35 | TM29×2 | M26×0.75 | 28 | 6.5 | 2.5 | 6 | 21.0 |
| 109-1525-5 | RM31WTR-40P | 40 | 41 | TM35×2 | M32×0.75 | 34 | 6.5 | 2.5 | 6 | 21.5 |
| 109-1527-0 | RM31WTR-40S | 40 | 41 | TM35×2 | M32×0.75 | 34 | 6.5 | 2.5 | 6 | 21.5 |
| 109-1526-8 | RM31WTR-55P | 55 | 41 | TM35×2 | M32×0.75 | 34 | 6.5 | 2.5 | 6 | 21.5 |
| 109-1528-3 | RM31WTR-55S | 55 | 41 | TM35×2 | M32×0.75 | 34 | 6.5 | 2.5 | 6 | 21.5 |

Remark: For the mounting holes, see page 60.

Cord Clamp

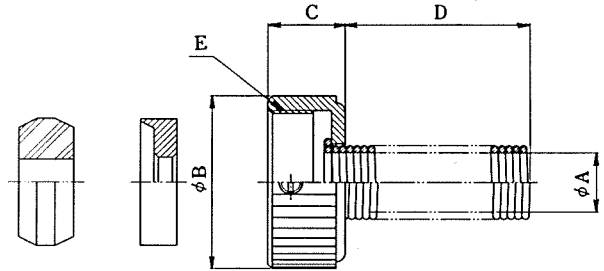
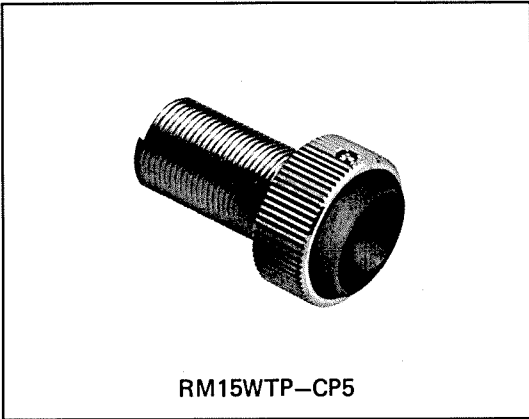

(An example in shape)

| HRS No. | Part No. | φA | φB | C | D | E | Cable dia. |
|------------|--------------|------|----|-----|----|----------|------------|
| 109-1249-0 | RM15WTP-CP5 | 6.5 | 19 | 8.5 | 20 | M16x0.75 | φ5 |
| 109-1250-9 | RM15WTP-CP6 | 6.5 | 19 | 8.5 | 20 | M16x0.75 | φ6 |
| 109-1251-1 | RM15WTP-CP7 | 8 | 19 | 8.5 | 20 | M16x0.75 | φ7 |
| 109-1252-4 | RM15WTP-CP8 | 10.5 | 19 | 8.5 | 20 | M16x0.75 | φ8 |
| 109-1253-7 | RM15WTP-CP9 | 10.5 | 19 | 8.5 | 20 | M16x0.75 | φ9 |
| 109-1254-0 | RM15WTP-CP10 | 10.5 | 19 | 8.5 | 20 | M16x0.75 | φ10 |
| 109-1405-3 | RM21WTP-CP8 | 10.3 | 23 | 7.5 | 30 | M20x0.75 | φ8 |
| 109-1406-6 | RM21WTP-CP10 | 10.3 | 23 | 7.5 | 30 | M20x0.75 | φ10 |
| 109-1407-9 | RM21WTP-CP12 | 12.3 | 23 | 7.5 | 30 | M20x0.75 | φ12 |
| 109-1493-0 | RM24WTP-CP10 | 12.5 | 27 | 8 | 30 | M24x0.75 | φ10 |
| 109-1494-3 | RM24WTP-CP12 | 12.5 | 27 | 8 | 30 | M24x0.75 | φ12 |
| 109-1495-6 | RM24WTP-CP14 | 16.5 | 27 | 8 | 30 | M24x0.75 | φ14 |
| 109-1496-9 | RM24WTP-CP16 | 16.5 | 27 | 8 | 30 | M24x0.75 | φ16 |
| 109-1575-3 | RM31WTP-CP10 | 14.5 | 31 | 12 | 30 | M28x0.75 | φ10 |
| 109-1576-6 | RM31WTP-CP12 | 14.5 | 31 | 12 | 30 | M28x0.75 | φ12 |
| 109-1579-4 | RM31WTP-CP14 | 14.5 | 31 | 12 | 30 | M28x0.75 | φ14 |
| 109-1577-9 | RM31WTP-CP16 | 18.5 | 31 | 12 | 30 | M28x0.75 | φ16 |
| 109-1578-1 | RM31WTP-CP18 | 18.5 | 31 | 12 | 30 | M28x0.75 | φ18 |

Note: Carefully chose the applicable cable because clamping force and waterproofness differ according to the type.

RM Series accessories

The RM series have accessories such as a cap, cord busing, and square flange designed for different applications.

Caps

The cap protects the mating surface and threads of the connector and prevents dust and water from entering. The cap is designed for both the standards and waterproof connector.

Plug cap

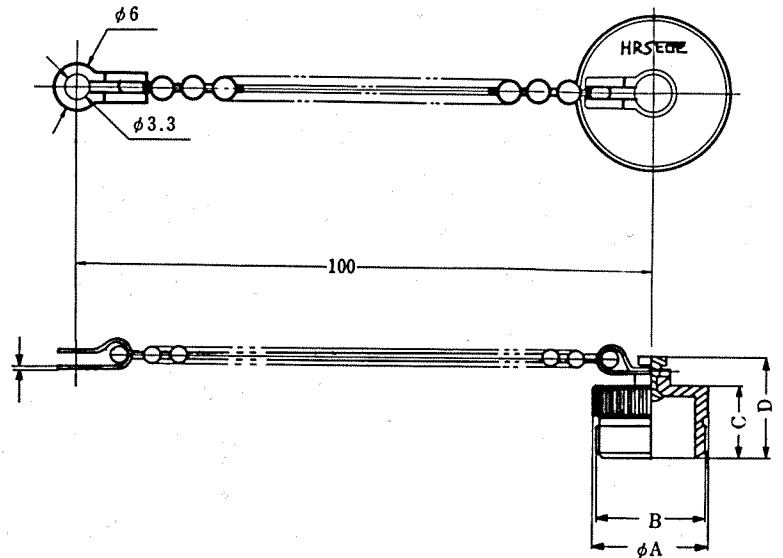
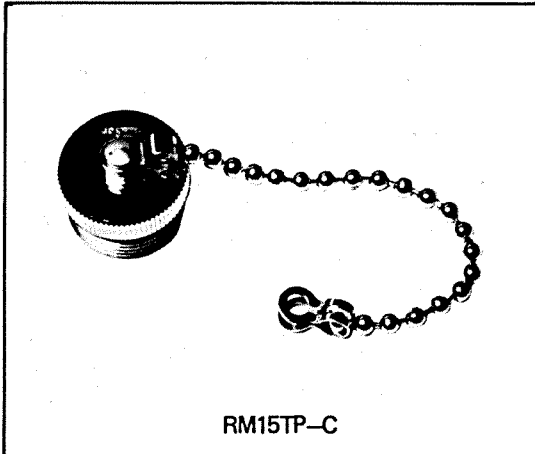

(An example in shape)

| HRS No. | Part No. | ϕA | B | C | D |
|------------|----------|----------|--------|------|------|
| 109-0079-6 | RM15TP-C | 21.5 | M19x1 | 12 | 16.5 |
| 109-0353-6 | RM21TP-C | 28 | TM25x2 | 17.5 | 22 |

Receptacle cap

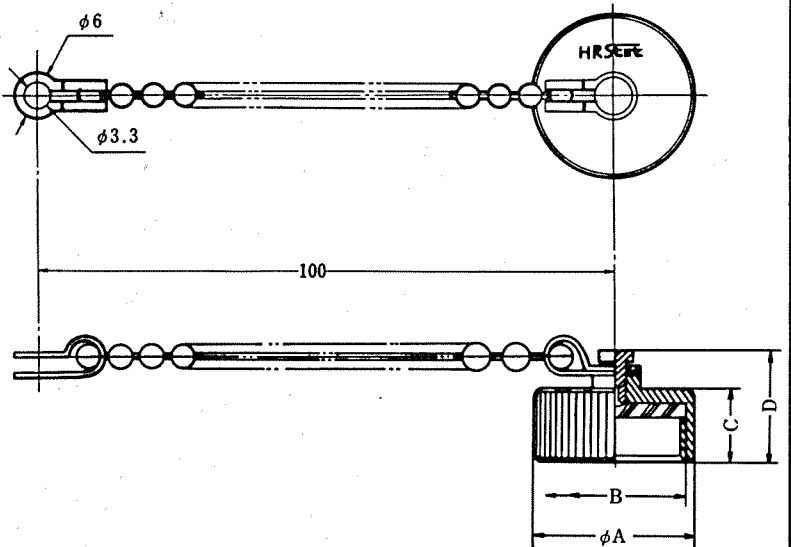
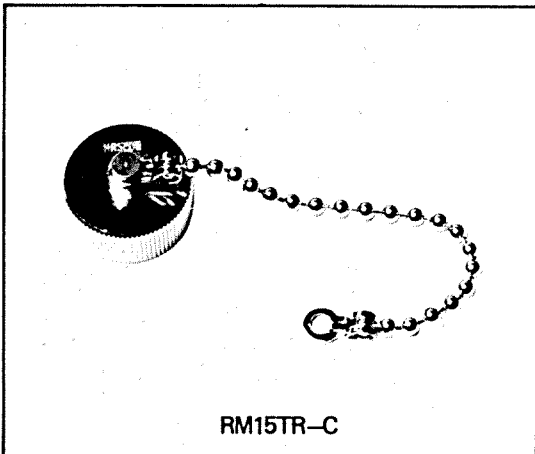

(An example in shape)

| HRS No. | Part No. | ϕA | B | C | D |
|------------|----------|----------|--------|-----|------|
| 109-0080-5 | RM15TR-C | 21.5 | M19x1 | 9 | 13.5 |
| 109-0354-9 | RM21TR-C | 28 | TM25x2 | 8 | 12.5 |
| 109-0492-2 | RM24TR-C | 32 | TM29x2 | 8.5 | 13 |
| 109-0394-3 | RM31TR-C | 38 | TM35x2 | 8.5 | 13 |

Square Flange

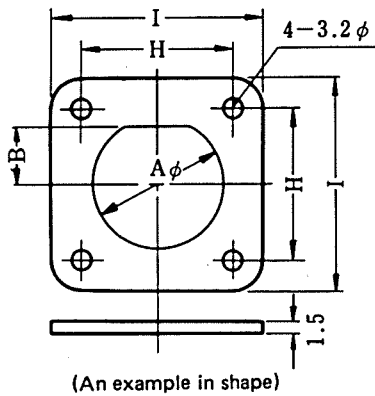

Square Flange is used with Bayonet Lock type receptacle.

| HRS No. | Part No. | ϕA | B | H | I |
|---------------|--------------|----------|-----|------|----|
| 109-0154-0-01 | RM12BR-F(01) | 14.1 | 6 | 18 | 26 |
| 109-0319-8-01 | RM15TR-F(01) | 17.1 | 7.6 | 20.6 | 28 |

Cord Bushing

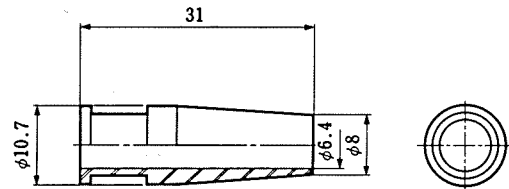

| HRS No. | Part No. | Remark. |
|------------|-----------|---------|
| 109-0776-0 | RM12BPG-B | |

How to use the RM15Q Connectors

(Quick insertion and extraction system)

1. Insertion

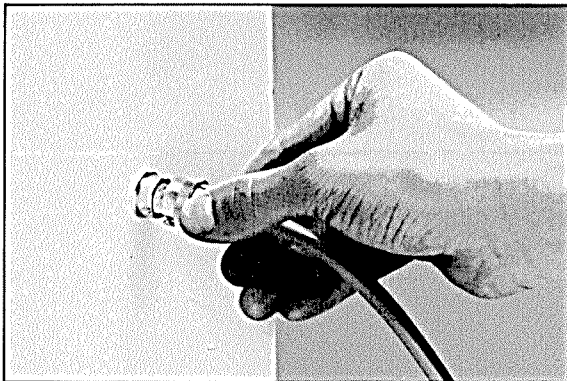

Holding the plug body, match the key with the keyway on the receptacle and push straight in. Turn plug 30° to the right, coupling is completed.

2. Extraction

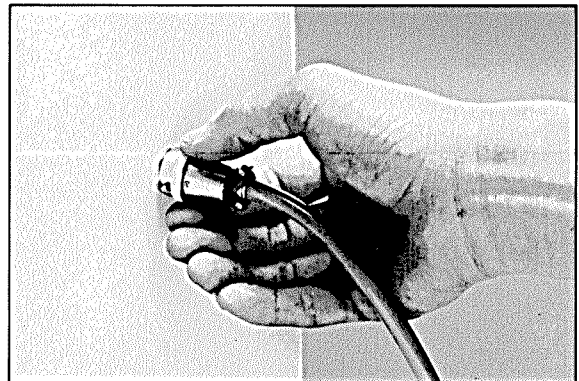

Holding plug sleeve, twist it 30 degrees to the left. Then, pull it straight for easy releasing.

Dimensions of mounting holes

For your reference, the dimensions of receptacle mounting holes are given below for different shell sizes for the nut-tightening type and square-flange type. In the case of the nut-tightening type, the dimensions of a

standard connector are the same as those of a waterproof connector. The dimensions of square flanges are those when the flanges are installed on the front surface of a panel. For details, contact our sales or engineering department.

Nut tightening type

Square flange type

Mounting holes, for shell sizes 12, 15

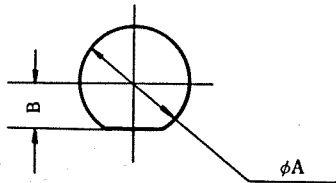

Mounting holes, for shell sizes 21, 24, 31

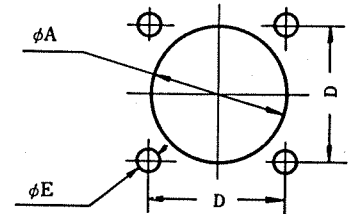
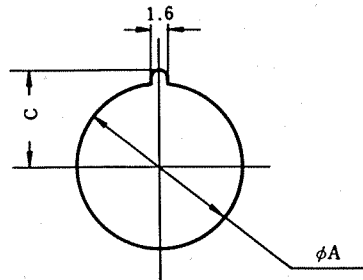



Remark: Use a 0.5 ~ 2 mm thickness panel for all shell sizes.



| Mounting method Shell size Locking mechanism Sign | Nut tightening | | | | | Square flange | |
|--|----------------|------|-------------|--------|------|---------------|------|
| | 12 | 15 | | 21 | 24 | 31 | 12 |
| | BRD·WBR | QRD | TRH·TRD·WTR | TR·WTR | | | BRB |
| φA | 14.1 | 17.1 | 17.1 | 22.1 | 26.1 | 32.1 | 14.5 |
| B | 6.1 | 7.6 | 7.6 | — | — | — | — |
| C | — | — | — | 13.3 | 14.6 | 18.3 | — |
| D | — | — | — | — | — | — | 16 |
| φE | — | — | — | — | — | — | 2.9 |

RM Series contact arrangement

| Shell size | | | | | | |
|-------------------------------|----------------------|----------------------|----------------------|----------------------|----------------------|----------------------|
| 12 | | | | | | |
| Contact arrangement number | 2 | 3 | 4 | 5 | 6 | 7 |
| Withstanding voltage | AC1800V for a minute | AC1500V for a minute | AC1500V for a minute | AC1000V for a minute | AC1000V for a minute | AC1000V for a minute |
| Current rating | 5A | 5A | 5A | 5A | 5A | 5A |
| Insulation resistance | 1000MΩ or more | 1000MΩ or more | 1000MΩ or more | 1000MΩ or more | 1000MΩ or more | 1000MΩ or more |
| Contact resistance | 4mΩ or less | 4mΩ or less | 4mΩ or less | 4mΩ or less | 4mΩ or less | 4mΩ or less |
| Inside diameter of solder pot | φ1.1 | φ1.1 | φ1.1 | φ1.1 | φ1.1 | φ1.1 |

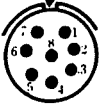
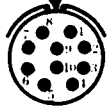
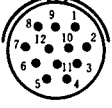
Contact arrangement

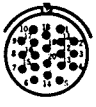
| Shell size |  |  |  |  |  |
|-------------------------------|---|---|---|--|---|
| 15 | | | | | |
| Contact arrangement number | 2 | 4 | 8 | 10 | 12 |
| Withstanding voltage | AC1800V for a minute | AC1500V for a minute | AC1500V for a minute | AC1000V for a minute | AC1000V for a minute |
| Current rating | 10A | 10A | 5A | 5A | 5A |
| Insulation resistance | 1000MΩ or more | 1000MΩ or more | 1000MΩ or more | 1000MΩ or more | 1000MΩ or more |
| Contact resistance | 2mΩ or less | 2mΩ or less | 4mΩ or less | 4mΩ or less | 4mΩ or less |
| Inside diameter of solder pot | φ1.7 | φ1.7 | φ1.1 | φ1.1 | φ1.1 |

| Shell size |  |  | Shell size |  |
|-------------------------------|--|--|-------------------------------|--|
| 21 | | | 24 | |
| Contact arrangement number | 15 | 20 | Contact arrangement number | 31 |
| Withstanding voltage | AC1500V for a minute | AC1000V for a minute | Withstanding voltage | AC1500V for a minute |
| Current rating | 5A | 5A | Current rating | 5A |
| Insulation resistance | 1000MΩ or more | 1000MΩ or more | Insulation resistance | 1000MΩ or more |
| Contact resistance | 4mΩ or less | 4mΩ or less | Contact resistance | 4mΩ or less |
| Inside diameter of solder pot | φ1.1 | φ1.1 | Inside diameter of solder pot | φ1.1 |

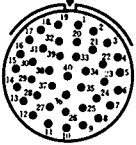
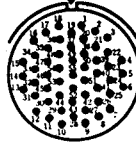
| Shell size |  |  |
|-------------------------------|---|---|
| 31 | | |
| Contact arrangement number | 40 | 55 |
| Withstanding voltage | AC1800V for a minute | AC1500V for a minute |
| Current rating | 5A | 5A |
| Insulation resistance | 1000MΩ or more | 1000MΩ or more |
| Contact resistance | 4mΩ or less | 4mΩ or less |
| Inside diameter of solder pot | φ1.1 | φ1.1 |

Remarks:

1. Figures show contact arrangements viewed from the fitting side of socket inserts (connecting side of pin inserts).
2. Withstanding voltage is shown in test voltage. In ordinary case, use connectors at about 1/3 of test voltage.
3. Insulator resistance is a value measured at DC 500V.
4. Contact resistance is a value measured at DC 1A.