



EVL3437-J-00A

High Efficiency, Fully-Integrated Synchronous Boost Converter EV Board

DESCRIPTION

The EVL3437-J-00A evaluation board is designed to demonstrate the capabilities of the MP3437. The MP3437 is a 600kHz, fixed-frequency, highly integrated boost converter with a wide input range. It starts from an input voltage as low as 2.7V, and supports up to 20W of peak load power from a single-cell battery.

The MP3437 adopts constant-off-time (COT) control topology to provide fast transient response. The cycle-by-cycle current limit on the low-side MOSFET (LS-FET) prevents current runaway, and the high-side MOSFET (HS-FET) eliminates the need for an external Schottky diode. The integrated LS-FET and HS-FET simplify the design and save BOM cost.

The MP3437 supports auto pass-through mode when V_{IN} exceeds $V_{OUT-SET}$. It also features a configurable input under-voltage lockout (UVLO) threshold and over-temperature protection (OTP).

The MP3437 is available in QFN-10 (2mmx2.5mm) and TSOT23-8 packages. This evaluation board is available in a TSOT23-8 package.

ELECTRICAL SPECIFICATIONS

Parameter	Symbol	Value	Units
Input voltage	V_{IN}	2.7 to 16	V
Output voltage	V_{OUT}	8	V
Output current	I_{OUT}	2.5	A

FEATURES

- 2.7V to 16V Start-Up Voltage ⁽¹⁾
- 0.8V to 16V Operation Voltage
- Up to 16V Output Voltage
- Supports 20W Peak Power Load from 3.3V
- 9.5A Internal Switch Current Limit
- Integrated 14mΩ and 21mΩ Power MOSFETs
- >89% Efficiency for 3.3V to 8V $V_{IN}/2.5A$
- Auto Pass-Through Function in PSM Mode
- 600kHz Fixed Switching Frequency
- Adaptive COT for Fast Transient Response
- Internal Soft Start and Compensation
- Configurable UVLO and Hysteresis
- 150°C Over-Temperature Protection (OTP)
- Over-Voltage Protection (OVP)
- Available in a TSOT23-8 Package
- Includes an MPS-Optimized Power Inductor

APPLICATIONS

- Notebooks
- AI Speakers
- Bluetooth Speakers
- Portable POS Systems

All MPS parts are lead-free, halogen-free, and adhere to the RoHS directive. For MPS green status, please visit the MPS website under Quality Assurance. "MPS", the MPS logo, and "Simple, Easy Solutions" are trademarks of Monolithic Power Systems, Inc. or its subsidiaries.

Note:

1) During input start-up, the inrush current through the high-side MOSFET body diode should be limited below 30A. The continuous current should not flow through high-side MOSFET body diode. Refer to the Input Power-up Inrush Current Control section in the MP3437 datasheet for additional details.

EVALUATION BOARD



(LxWxH) 6.4cmx6.4cmx0.6cm

Board Number	MPS IC Number
EVL3437-J-00A	MP3437GJ

Efficiency

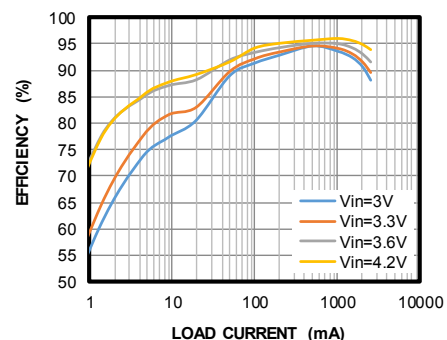

QUICK START GUIDE

The output voltage of this board is set to 8V. The board layout accommodates most commonly used components. To quick start the EVL3437-J-00A, follow the steps below:

1. Preset the power supply (V_{IN}) between 2.7V and 16V.
2. Turn the power supply off.
3. Connect the power supply terminals to:
 - a) Positive (+): VIN
 - b) Negative (-): GND
4. Connect the load to:
 - a) Positive (+): VOUT
 - b) Negative (-): GND
5. Turn the power supply on after making the connections.⁽²⁾
6. The MP3437 is enabled on the evaluation board once V_{IN} is applied.
7. The output voltage (V_{OUT}) can be changed by varying the value of R2. Calculate V_{OUT} with Equation (1):

$$V_{OUT} = V_{FB} \times \left(1 + \frac{R1}{R2}\right) \quad (1)$$

Where $V_{FB} = 1V$ and $R1 = 750k\Omega$. If $V_{OUT-SET}$ exceeds 15V, place an RC snubber on SW to GND. The recommended values are $R6 = 1\Omega$, and $C5 = 2.2nF$.

8. If the auto pass-through function is required, increase the input voltage above $V_{OUT-SET}$. The MP3437 automatically enters auto pass-through.

Note:

2) The inrush current through high-side MOSFET body diode should be limited less than 30A. Refer to the Input Power-up Inrush Current Control section in the MP3437 datasheet for more details.

EVALUATION BOARD SCHEMATIC

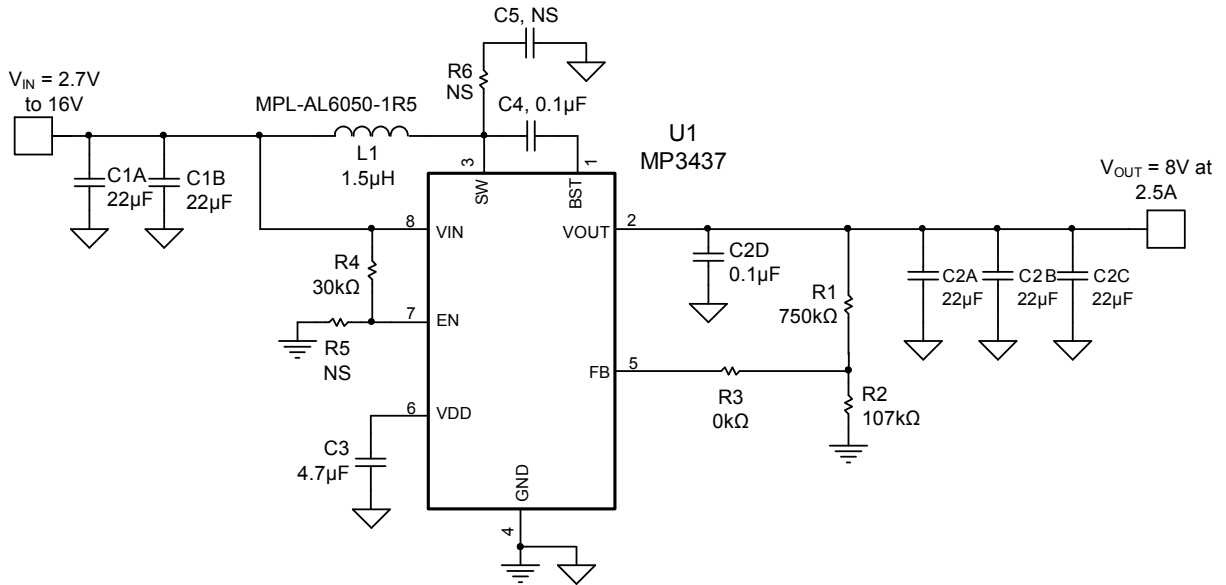

EVL3437-J-00A BILL OF MATERIALS

Qty	Ref	Value	Description	Package	Manufacturer	Manufacturer P/N
1	L1	1.5 μ H	Inductor, RDC = 6m Ω , I _{SAT} = 18A	SMD	MPS	MPL-AL6050-1R5
5	C1A, C1B, C2A, C2B, C2C	22 μ F	Ceramic capacitor, 25V, X7R	1210	Murata	GRM32ER71E226KE20L
2	C2D, C4	100nF	Ceramic capacitor, 25V, X7R	0402	Murata	GRM155R71E104KA88D
1	C3	4.7 μ F	Ceramic capacitor, 16V, X7R	0603	Murata	GRM188Z71C475KE21D
1	R1	750k Ω	Film resistor, 1%	0603	Yageo	RC0603FR-07750KL
1	R2	107k Ω	Film resistor, 1%	0603	Yageo	RC0603FR-07107KL
1	R3	0 Ω	Film resistor, 1%	0603	Yageo	RC0603FR-070RL
1	R4	30k Ω	Film resistor, 1%	0603	Yageo	RC0603FR-0730KL
0	R5, R6, C5	NS				
1	U1	MP3437	16V/9.5A boost converter	TSOT23-8	MPS	MP3437GJ

EVb TEST RESULTS

$V_{IN} = 3.3V$, $V_{OUT} = 8V$, $L = 1.5\mu H$, $I_{OUT} = 2.5A$, $T_A = 25^\circ C$, unless otherwise noted.

Efficiency

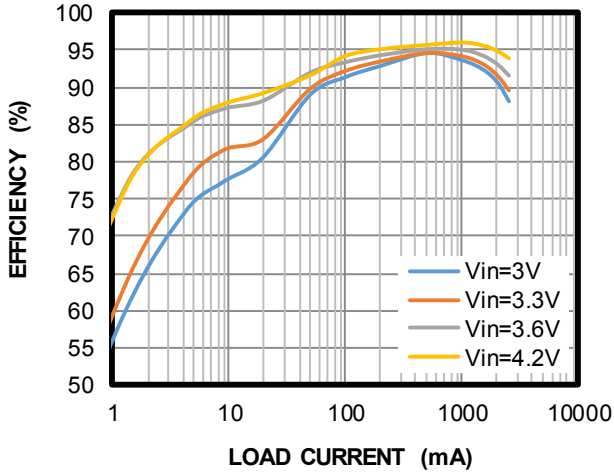

Load Regulation

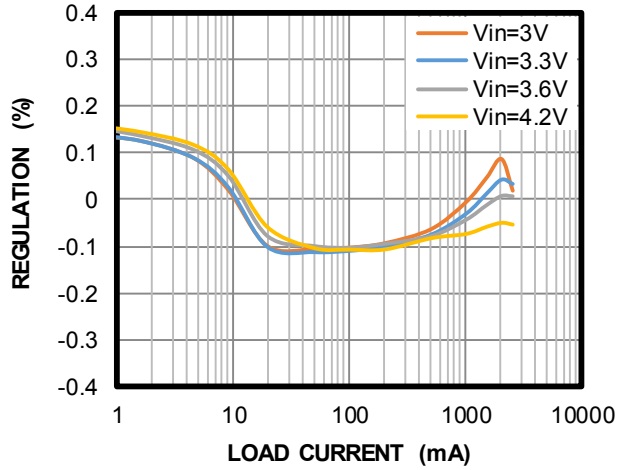

Line Regulation

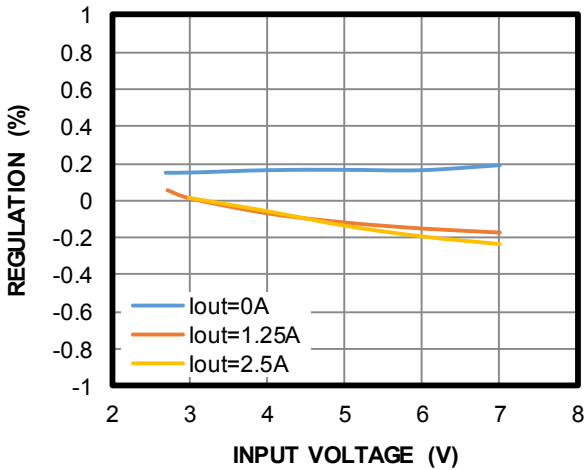

Bode Plot

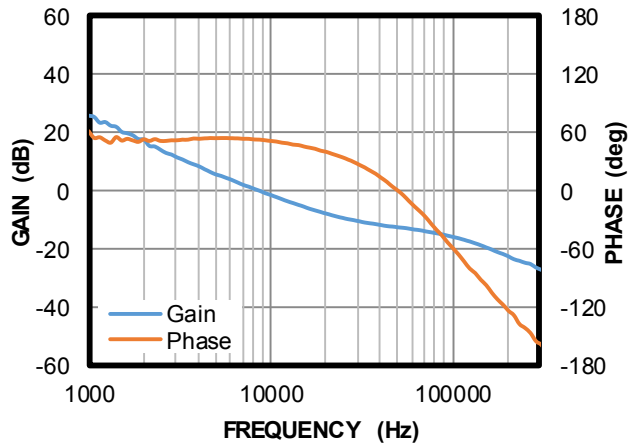

Case Temperature Rising

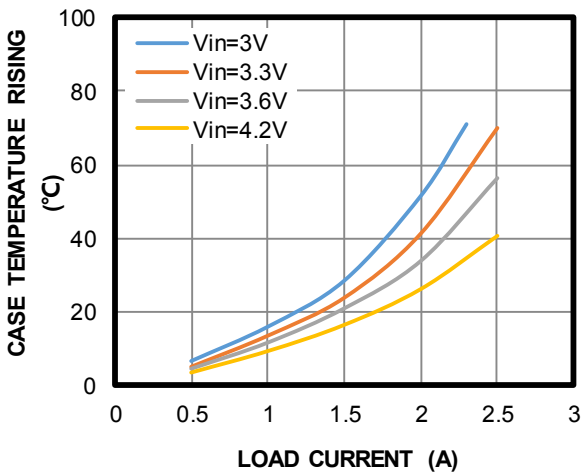

EVB TEST RESULTS (continued)

$V_{IN} = 3.3V$, $V_{OUT} = 8V$, $L = 1.5\mu H$, $I_{OUT} = 2.5A$, $T_A = 25^\circ C$, unless otherwise noted.

Steady State

$I_{OUT} = 0A$

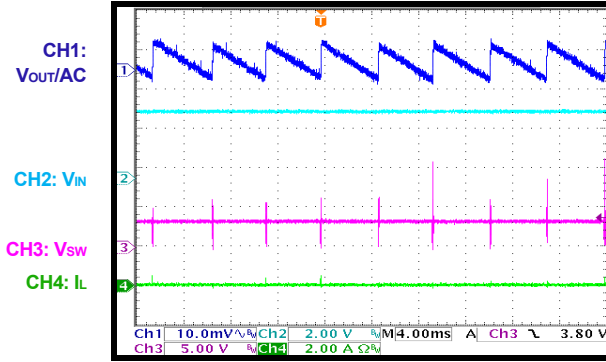

Steady State

$I_{OUT} = 2.5A$

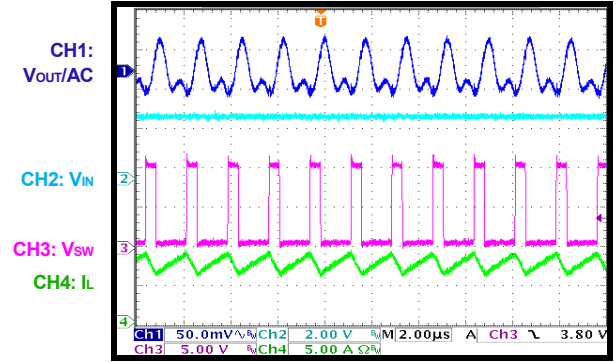

VIN Start-Up

$I_{OUT} = 0A$

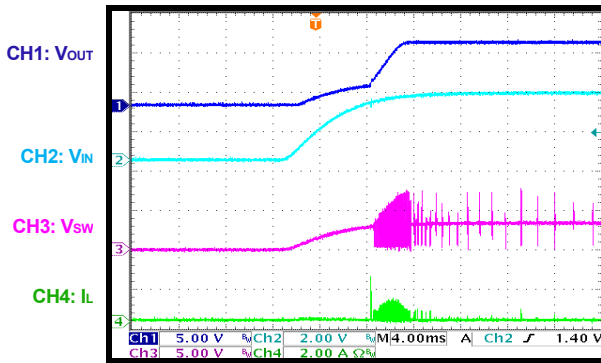

VIN Start-Up

$I_{OUT} = 2.5A$

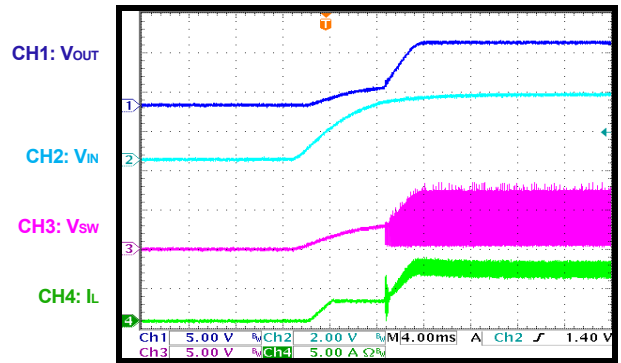

VIN Shutdown

$I_{OUT} = 0A$

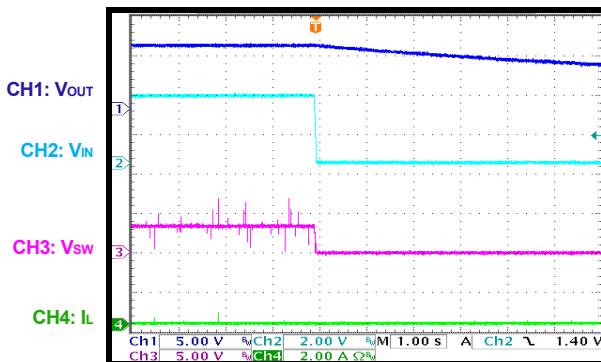

VIN Shutdown

$I_{OUT} = 2.5A$

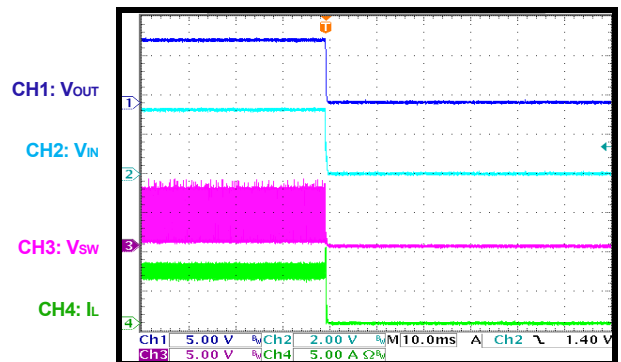

EVB TEST RESULTS (continued)

$V_{IN} = 3.3V$, $V_{OUT} = 8V$, $L = 1.5\mu H$, $I_{OUT} = 2.5A$, $T_A = 25^\circ C$, unless otherwise noted.

EN Start-Up

$I_{OUT} = 0A$

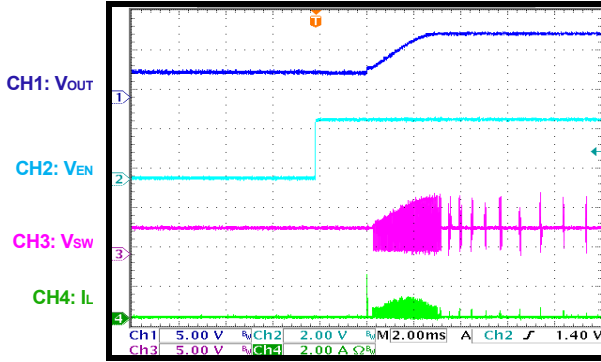

EN Start-Up

$I_{OUT} = 2.5A$

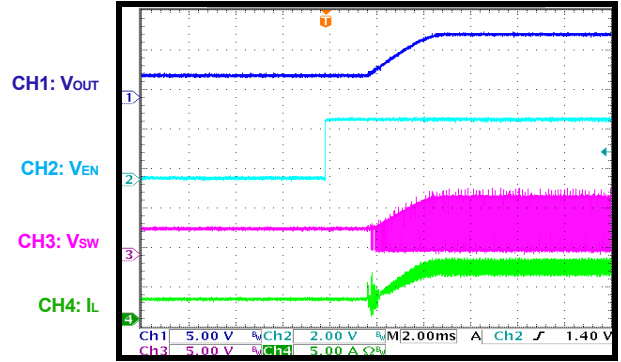

EN Shutdown

$I_{OUT} = 0A$

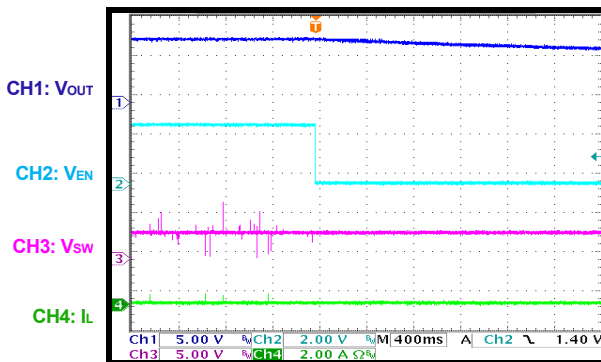

EN Shutdown

$I_{OUT} = 2.5A$

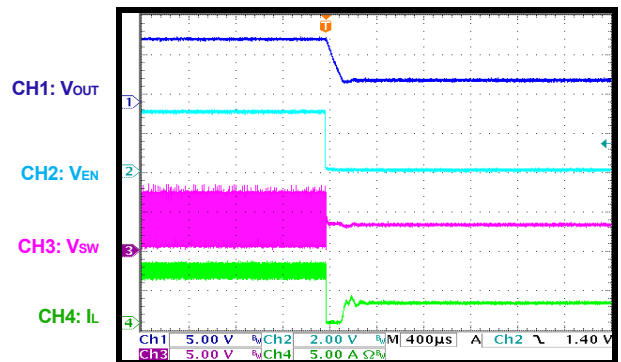

Load Transient

$I_{OUT} = 0A$ to $1.25A$

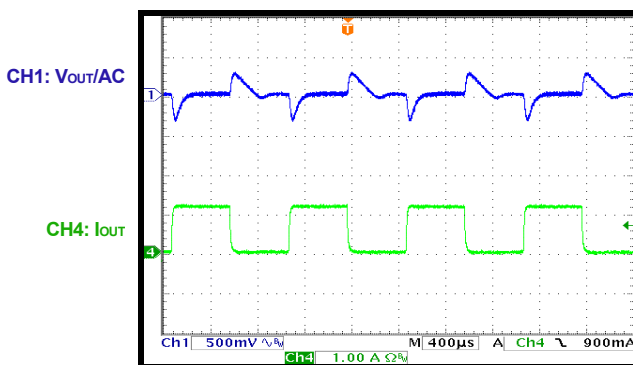

Load Transient

$I_{OUT} = 1.25A$ to $2.5A$

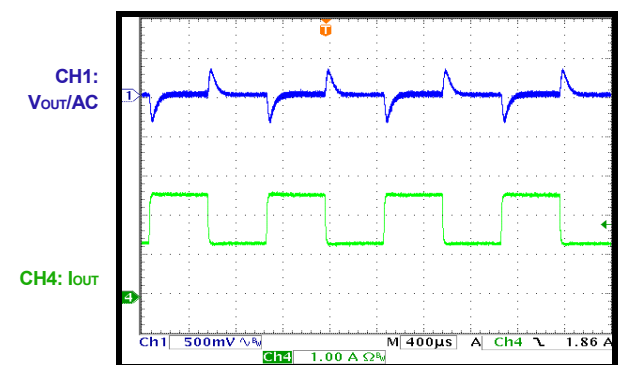

EVB TEST RESULTS (continued)

$V_{IN} = 3.3V$, $V_{OUT} = 8V$, $L = 1.5\mu H$, $I_{OUT} = 2.5A$, $T_A = 25^\circ C$, unless otherwise noted.

Over-Current Entry
Increase output current, 0A to 4.5A

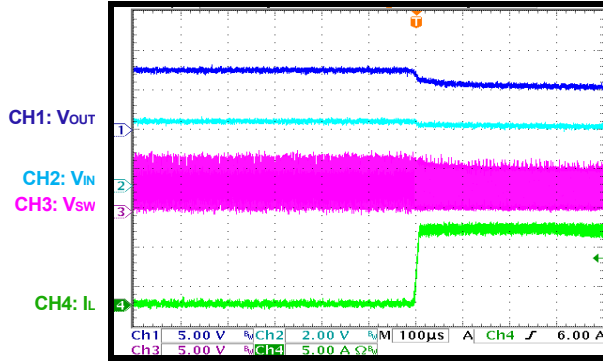

Over-Current Recovery
Decrease output current, 4.5A to 0A

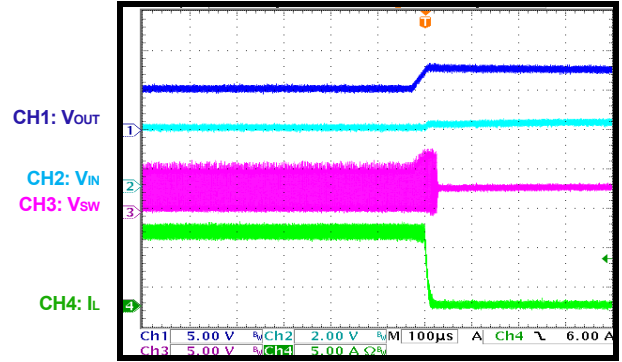

PCB LAYOUT

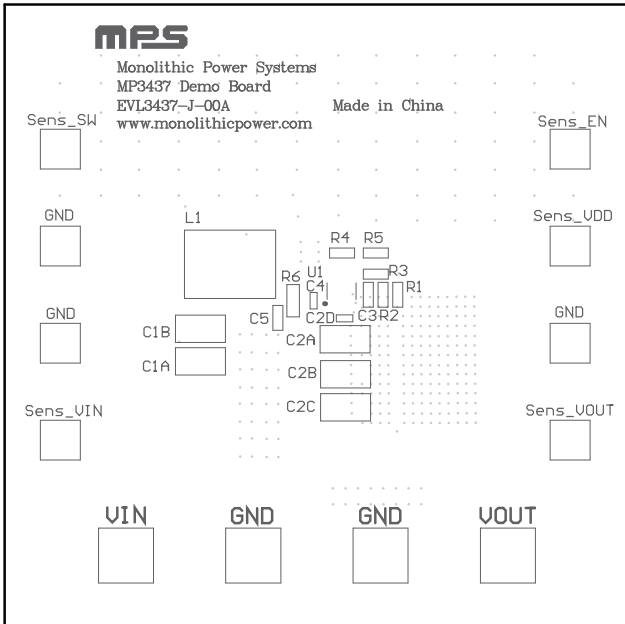

Figure 1: Top Silk

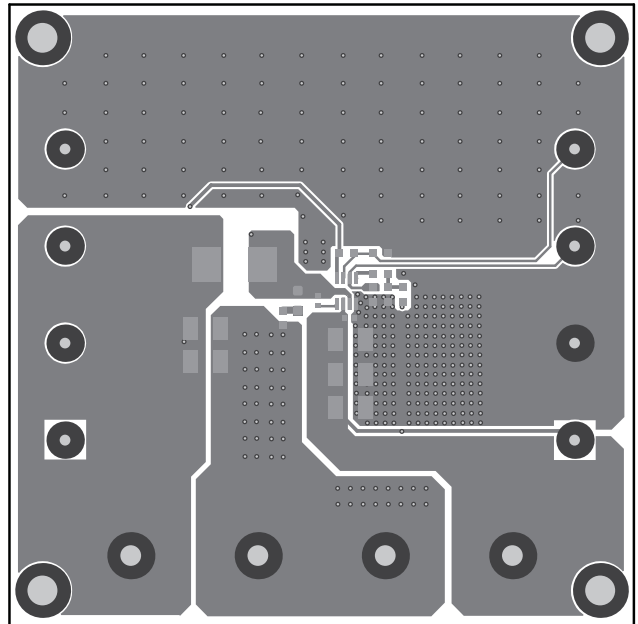

Figure 2: Top Layer

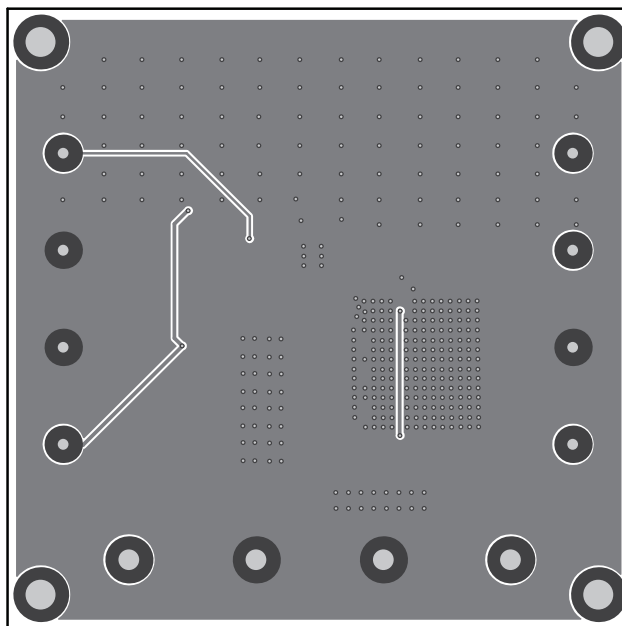

Figure 3: Bottom Layer

Notice: The information in this document is subject to change without notice. Please contact MPS for current specifications. Users should warrant and guarantee that third-party Intellectual Property rights are not infringed upon when integrating MPS products into any application. MPS will not assume any legal responsibility for any said applications.