

2-stage filter for 3-phase systems

new



See below:

**Approvals and Compliances**

**Description**

- Terminals for three phases and ground
- 2 stage
- Very high attenuation
- Industrial or low leakage current versions

**Unique Selling Proposition**

- Compact design with small footprint
- Double-stage filter for high attenuation
- High voltage versions
- Wide temperature range

**Applications**

- Voltage rating 520 or 760 VAC for various applications
- Protection against interference voltage from the mains
- Especially designed for industrial applications such as: Frequency Converters, Stepper Motor Drives, UPS-Systems, Inverters
- Variants Machine Safety suitable for machine applications according to IEC 60204-1
- Suitable for use in equipment according to IEC/UL 62368-1

**Weblinks**

[pdf data sheet](#), [html datasheet](#), [General Product Information](#), [Approvals](#), [Distributor-Stock-Check](#), [Detailed request for product](#), [Microsite](#)

**Technical Data**

Rated Current	16 - 230A
Rated voltage	520/760 VAC, 50/60 Hz
Approval for	16 - 230A @ 40 °C / 520/760 VAC; 50/60Hz
Overload Current	1.5 x I <sub>r</sub> for 1 minute, per hour
Dielectric Strength	> 520V / 2.25kVDC between L-L
	> 520V / 2.75kVDC between L-PE
	Test voltage 2 sec between > 520V / 2.75kVDC L-PE Test voltage 2 sec/50Hz
Number of Filter Stages	2-stage
Weight	1 - 5.4 kg
Material: Housing	Metal
Sealing Compound	UL 94V-0

Mounting	Screw-on mounting on chassis
Terminal	Screw clamps
Operating Temperature	-40°C to 100°C
Climatic Category	40/100/21 acc. to IEC 60068-1
Degree of Protection	IP20 acc. to IEC 60529
Protection Class	Suitable for appliances with protection class I acc. to IEC 61140
MTBF	> 200'000h acc. to MIL-HB-217 F

**Approvals and Compliances**

Detailed information on product approvals, code requirements, usage instructions and detailed test conditions can be looked up in [Details about Approvals](#)

SCHURTER products are designed for use in industrial environments. They have approvals from independent testing bodies according to national and international standards. Products with specific characteristics and requirements such as required in the automotive sector according to IATF 16949, medical technology according to ISO 13485 or in the aerospace industry can be offered exclusively with customer-specific, individual agreements by SCHURTER.

**Approvals**



The approval mark is used by the testing authorities to certify compliance with the safety requirements placed on electronic products.

Approval Reference Type: FMBC EP

Approval Logo	Certificates	Certification Body	Description
	<a href="#">VDE Approvals</a>	VDE	Certificate Number: 40052415
	<a href="#">UL Approvals</a>	UL	UR File Number: E495089

**Product standards**

Product standards that are referenced

Organization	Design	Standard	Description
	Designed according to	IEC 60939	Passive filters for suppressing electromagnetic interference
	Designed according to	UL 60939-3	Electromagnetic interference filters
	Designed according to	CSA C22.2 no. 8	Electromagnetic interference (EMI) filters





**Application standards**

Application standards where the product can be used

Organization	Design	Standard	Description
	Suitable for applications acc.	IEC/UL 62368-1	Audio/video, information and communication technology equipment - Part 1: Safety requirements

**Compliances**

The product complies with following Guide Lines

Identification	Details	Initiator	Description
	<a href="#">CE declaration of conformity</a>	SCHURTER AG	The CE marking declares that the product complies with the applicable requirements laid down in the harmonisation of Community legislation on its affixing in accordance with EU Regulation 765/2008.
	<a href="#">UKCA declaration of conformity</a>	SCHURTER AG	The UKCA marking declares that the product complies with the applicable requirements laid down in the British Amendment of Regulation (EC) 765/2008.
	RoHS	SCHURTER AG	Directive RoHS 2011/65/EU, Amendment (EU) 2015/863
	China RoHS	SCHURTER AG	The law SJ / T 11363-2006 (China RoHS) has been in force since 1 March 2007. It is similar to the EU directive RoHS.
	REACH	SCHURTER AG	On 1 June 2007, Regulation (EC) No 1907/2006 on the Registration, Evaluation, Authorization and Restriction of Chemicals 1 (abbreviated as "REACH") entered into force.

**Dimension [mm]**

Case 5A-4

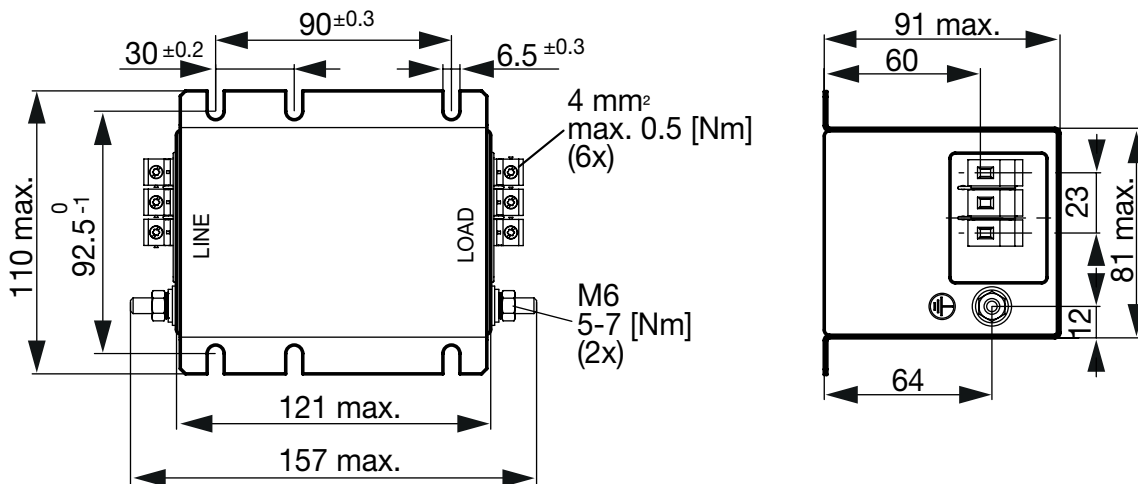

Case 5A-10

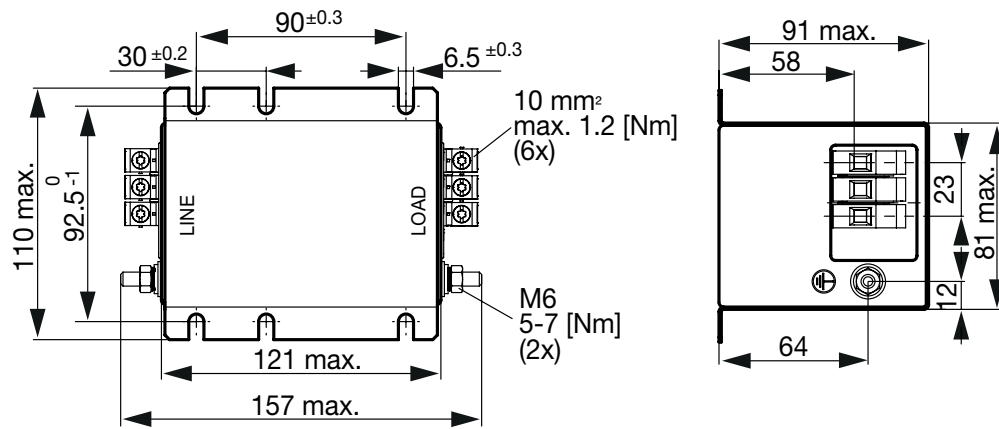

Case 5B-10

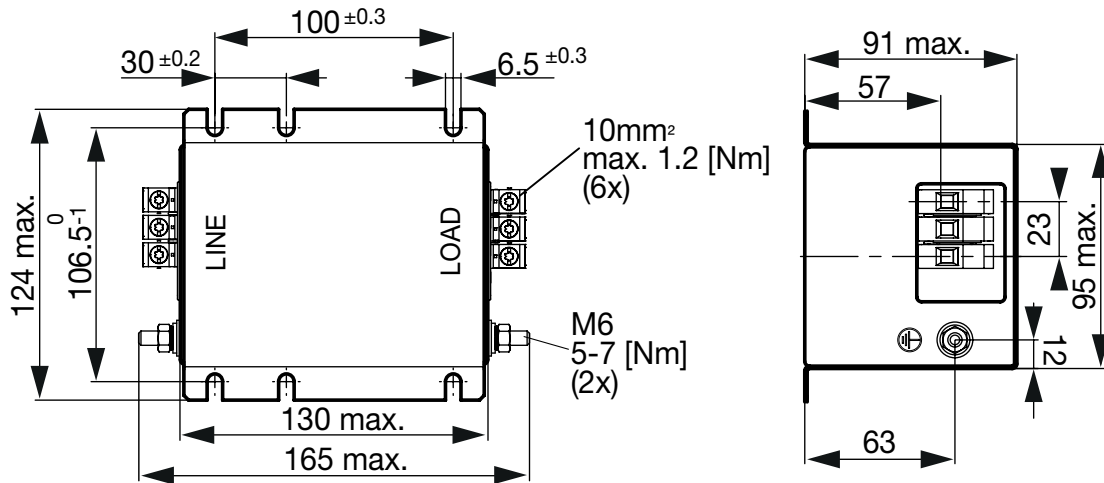

Case 5B-16

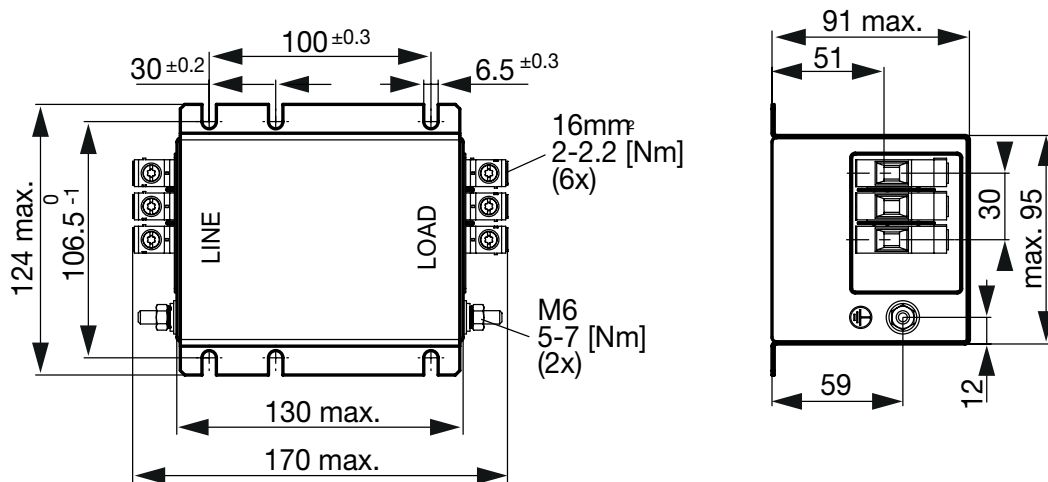

Case 4C-25

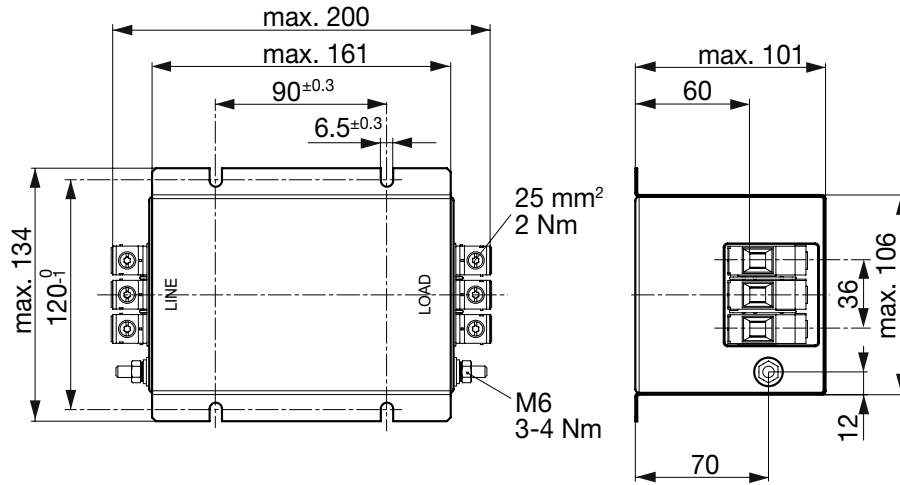

Case 4C-50

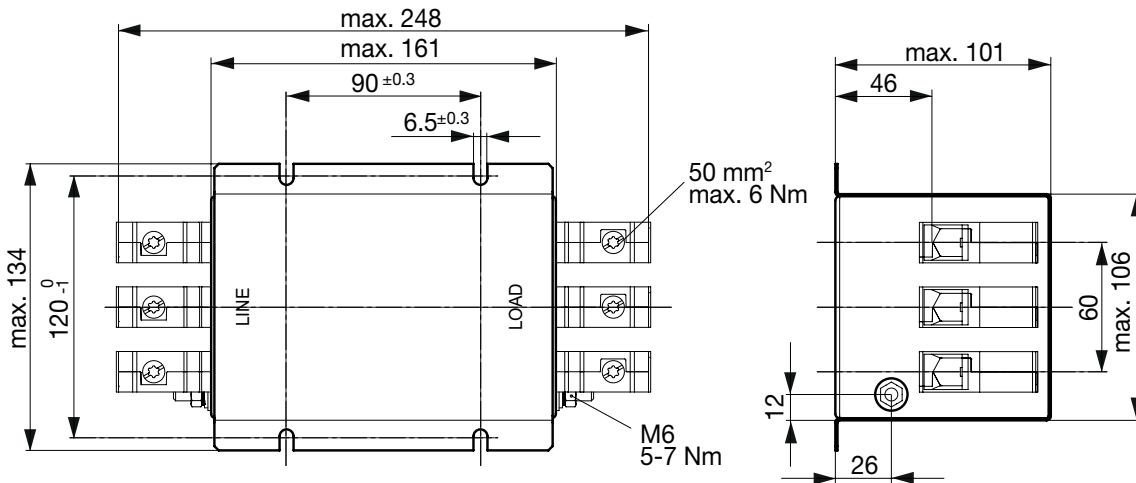

Case 4D

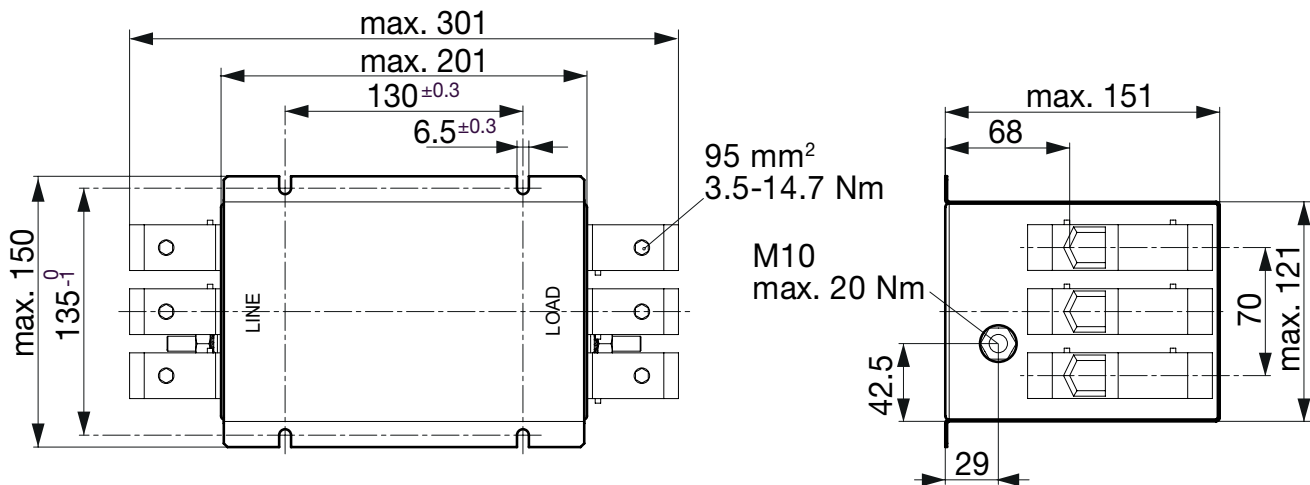

Diagrams

Industrial version

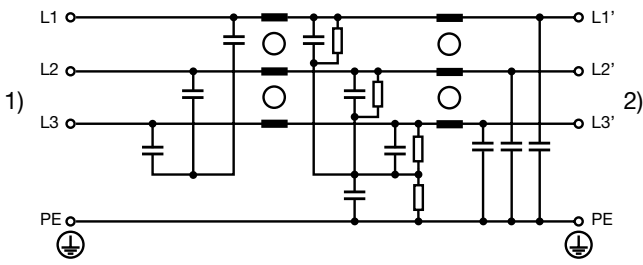

- 1) Line
- 2) Load

**Attenuation Loss** . . . . 0.1/100Ω differential mode ..... 100/0.1Ω differential mode - - - 50Ω differential mode \_\_\_\_ 50Ω common mode

Industrial version

16 A / 520 V

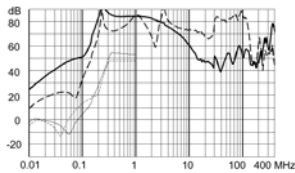

25 A / 520 V

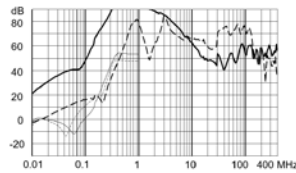

36 A / 520 V

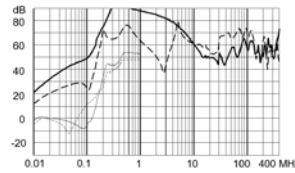

50 A / 520 V

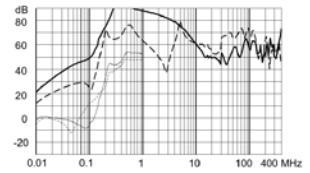

64 A / 520 V

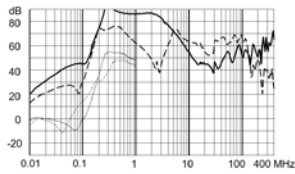

80 A / 520 V

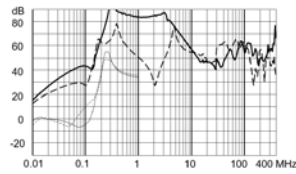

110 A / 520 V

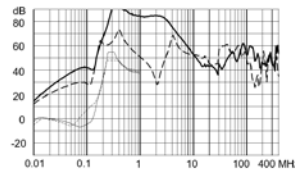

180 A / 520 V

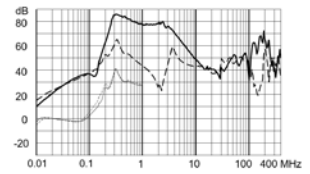

230 A / 520 V

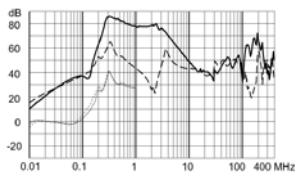

16 A / 760 V

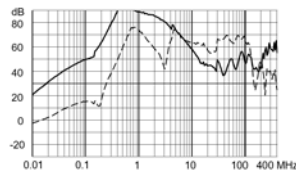

25 A / 760 V

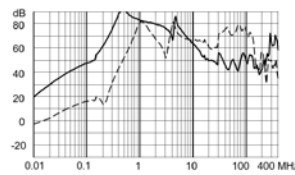

36 A / 760 V

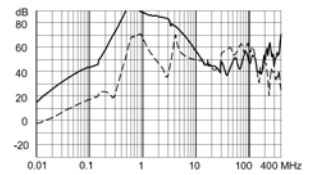

50 A / 760 V

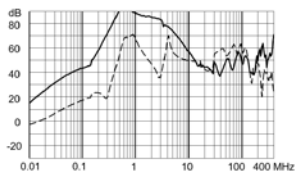

64 A / 760 V

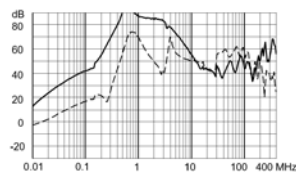

80 A / 760 V

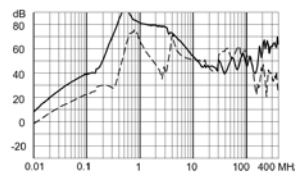

110 A / 760 V

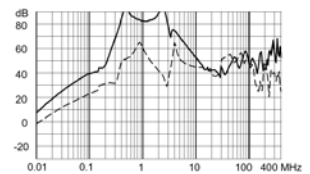

180 A / 760 V

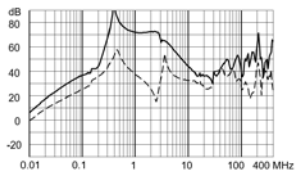

230 A / 760 V

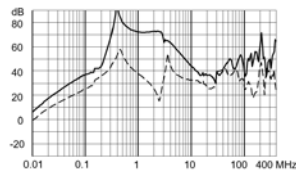

Low leakage current version

16 A / 520 V

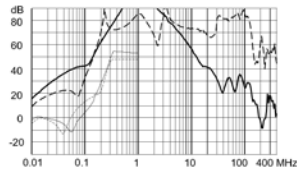

25 A / 520 V

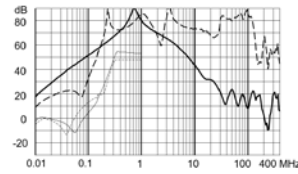

36 A / 520 V

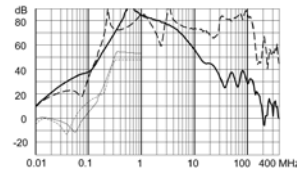

50 A / 520 V

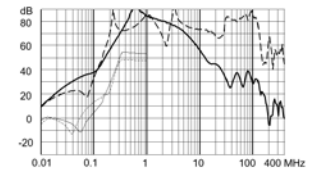

64 A / 520 V

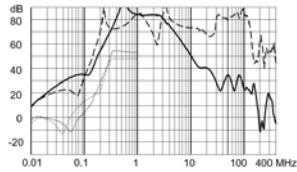

16 A / 760 V

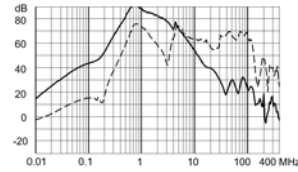

25 A / 760 V

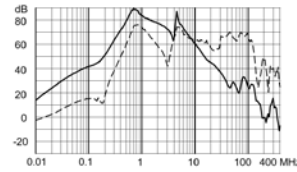

36 A / 760 V

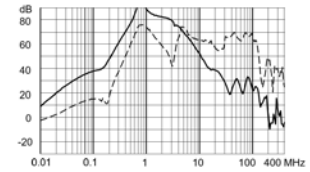

50 A / 760 V

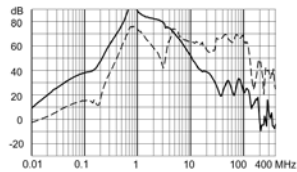

64 A / 760 V

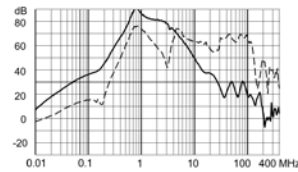

All Variants

Rated Current @ Ta 40°C [A]	Rated Voltage [VAC]	Filter Type	Machine Safety	Tripped Power Dissipation [W]	Contact Resistance [mΩ]	Leakage Current [mA] @ 440V, 60Hz 1)	Weight [kg]	Screw clamps [mm <sup>2</sup> 2)	Housing	Order Number
16	520	Industrial version		1.6	6.2	2.88	1 kg	4	5A-4	3-123-459
25	520	Industrial version		2.1	3.4	3.58	1.2 kg	10	5A-10	3-123-460
36	520	Industrial version		2.2	1.7	3.75	1.4 kg	10	5B-10	3-123-461
50	520	Industrial version		4.2	1.7	3.75	1.4 kg	10	5B-10	3-123-482
64	520	Industrial version		6.9	1.7	3.75	1.7 kg	16	5B-16	3-123-483
80	520	Industrial version		7.7	1.2	3.77	2.2 kg	25	4C-25	3-123-484
110	520	Industrial version		6.1	0.5	3.77	2.7 kg	50	4C-50	3-123-485
180	520	Industrial version		12.9	0.4	3.91	4.6 kg	95	4D	3-123-486
230	520	Industrial version		15.8	0.3	3.91	5.4 kg	95	4D	3-123-487
16	520	Low leakage current version		1.6	6.2	0.8	1 kg	4	5A-4	3-123-488
25	520	Low leakage current version		2.1	3	0.8	1.2 kg	10	5A-10	3-123-489
36	520	Low leakage current version		2.2	2.4	0.8	1.4 kg	10	5B-10	3-123-490
50	520	Low leakage current version		4.2	2.4	0.8	1.4 kg	10	5B-10	3-123-491
64	520	Low leakage current version		6.9	0.9	0.8	1.7 kg	16	5B-16	3-123-492
16	760	Industrial version		1.6	6.2	1.64	1 kg	4	5A-4	3-123-493
25	760	Industrial version		2.1	3.4	1.64	1.2 kg	10	5A-10	3-123-494
36	760	Industrial version		2.2	1.7	1.64	1.4 kg	10	5B-10	3-123-495
50	760	Industrial version		4.2	1.7	1.64	1.4 kg	10	5B-10	3-123-496
64	760	Industrial version		6.9	1.7	1.64	1.7 kg	16	5B-16	3-123-497
80	760	Industrial version		7.7	1.2	2.21	2.2 kg	25	4C-25	3-123-498

Rated Current @ Ta 40°C [A]	Rated Voltage [VAC]	Filter Type	Machine Safety	Tripped Power Dissipation [W]	Contact Resistance [mΩ]	Leakage Current [mA] @ 440V, 60Hz 1)	Weight [kg]	Screw clamps [mm <sup>2</sup> 2)	Housing	Order Number
110	760	Industrial version		6.1	0.5	2.21	2.7 kg	50	4C-50	3-123-499
180	760	Industrial version		12.9	0.4	3.03	4.6 kg	95	4D	3-123-500
230	760	Industrial version		15.8	0.3	3.03	5.1 kg	95	4D	3-123-501
16	760	Low leakage current version		1.6	6.2	1.1	1 kg	4	5A-4	3-123-502
25	760	Low leakage current version		2.1	3	1.1	1.2 kg	10	5A-10	3-123-503
36	760	Low leakage current version		2.2	2.4	1.1	1.4 kg	10	5B-10	3-123-504
50	760	Low leakage current version		4.2	2.4	1.1	1.4 kg	10	5B-10	3-123-505
64	760	Low leakage current version		6.9	0.9	1.1	1.7 kg	16	5B-16	3-123-506
16	520	Industrial version	●	1.6	6.2	2.88	1 kg	4	5A-4	3-138-321
25	520	Industrial version	●	2.1	3.4	3.58	1.2 kg	10	5A-10	3-138-322
36	520	Industrial version	●	2.2	1.7	3.75	1.4 kg	10	5B-10	3-138-323
50	520	Industrial version	●	4.2	1.7	3.75	1.4 kg	10	5B-10	3-138-324
64	520	Industrial version	●	6.9	1.7	3.75	1.7 kg	16	5B-16	3-138-325
80	520	Industrial version	●	7.7	1.2	3.77	2.2 kg	25	4C-25	3-138-326
110	520	Industrial version	●	6.1	0.5	3.77	2.7 kg	50	4C-50	3-138-327
180	520	Industrial version	●	12.9	0.4	3.91	4.6 kg	95	4D	3-138-328
230	520	Industrial version	●	15.8	0.3	3.91	5.4 kg	95	4D	3-138-329
16	520	Low leakage current version	●	1.6	6.2	0.8	1 kg	4	5A-4	3-138-330
25	520	Low leakage current version	●	2.1	3	0.8	1.2 kg	10	5A-10	3-138-331
36	520	Low leakage current version	●	2.2	2.4	0.8	1.4 kg	10	5B-10	3-138-332
50	520	Low leakage current version	●	4.2	2.4	0.8	1.4 kg	10	5B-10	3-138-333
64	520	Low leakage current version	●	6.9	0.9	0.8	1.7 kg	16	5B-16	3-138-334
16	760	Industrial version	●	1.6	6.2	1.64	1 kg	4	5A-4	3-138-335
25	760	Industrial version	●	2.1	3.4	1.64	1.2 kg	10	5A-10	3-138-336
36	760	Industrial version	●	2.2	1.7	1.64	1.4 kg	10	5B-10	3-138-337
50	760	Industrial version	●	4.2	1.7	1.64	1.4 kg	10	5B-10	3-138-338
64	760	Industrial version	●	6.9	1.7	1.64	1.7 kg	16	5B-16	3-138-339
80	760	Industrial version	●	7.7	1.2	2.21	2.2 kg	25	4C-25	3-138-340
110	760	Industrial version	●	6.1	0.5	2.21	2.7 kg	50	4C-50	3-138-341
180	760	Industrial version	●	12.9	0.4	3.03	4.6 kg	95	4D	3-138-342
230	760	Industrial version	●	15.8	0.3	3.03	5.1 kg	95	4D	3-138-343
16	760	Low leakage current version	●	1.6	6.2	1.1	1 kg	4	5A-4	3-138-344
25	760	Low leakage current version	●	2.1	3	1.1	1.2 kg	10	5A-10	3-138-345
36	760	Low leakage current version	●	2.2	2.4	1.1	1.4 kg	10	5B-10	3-138-346
50	760	Low leakage current version	●	4.2	2.4	1.1	1.4 kg	10	5B-10	3-138-347
64	760	Low leakage current version	●	6.9	0.9	1.1	1.7 kg	16	5B-16	3-138-348

Most Popular.

Availability for all products can be searched real-time: <https://www.schurter.com/en/Stock-Check/Stock-Check-SCHURTER>

1) Leakage current according IEC 60939-1

2) Maximum conductor cross section (wire gauge) to be used; a comparative table for AWG and mm<sup>2</sup> values can be found in the general product information <https://www.schurter.com/en/FAQ#10>

**Packaging unit**

1 Pcs

The specifications, descriptions and illustrations indicated in this document are based on current information. All content is subject to modifications and amendments. Information furnished is believed to be accurate and reliable. However, users should independently evaluate the suitability and test each product selected for their own applications.