

Display ▪ Surface-mount EADST040RA2



Features

- Industrial standard size.
- Packaged in tape and reel for SMT manufacturing.
- The thickness is thinner than traditional display.
- Low power consumption.
- Categorized for luminous intensity.
- Pb free and RoHS compliant.

Description

- EADST040RA2 is a 10.0 mm (0.39") digit height seven-segment display.
- The display provides excellent reliability in bright ambient light.
- The device is made with white segments and gray surface.

Applications

- Home appliances
- Instrument panels
- Digital readout displays

Device Selection Guide

Chip Materials	Emitted Color	Resin Color
AlGaInP	Brilliant Red	White Diffusion

Absolute Maximum Ratings (Ta=25°C)

Parameter	Symbol	Rating	Unit
Reverse Voltage	V_R	5	V
Forward Current	I_F	25	mA
Peak Forward Current (Duty 1/10 @1KHz)	I_{FP}	60	mA
Power Dissipation	P_d	60	mW
Operating Temperature	T_{opr}	-40 ~ +105	°C
Storage Temperature	T_{stg}	-40 ~ +105	°C
Soldering Temperature (Soldering time \leq 5 seconds)	T_{sol}	260	°C

Electro-Optical Characteristics (Ta=25°C)

Parameter	Symbol	Min.	Typ.	Max.	Unit	Condition
Luminous Intensity ^{*1}	I_v	7.8	17.6	-----	mcd	$I_F=10mA$
Peak Wavelength	λ_p	-----	632	-----	nm	$I_F=20mA$
Dominant Wavelength	λ_d	-----	624	-----	nm	$I_F=20mA$
Spectrum Radiation Bandwidth	$\Delta\lambda$	-----	20	-----	nm	$I_F=20mA$
Forward Voltage	V_F	-----	2.0	2.4	V	$I_F=20mA$
Reverse Current	I_R	-----	-----	10	μA	$V_R=5V$

Note:

- Luminous Intensity is a average value which is measured one 7-segment.
- Tolerance of Luminous Intensity: $\pm 10\%$
- Tolerance of Forward Voltage: $\pm 0.1V$

Bin Range of Luminous Intensity

Bin Code	Min.	Max.	Unit	Condition
Q	7.8	12.5	mcd	$I_F = 10\text{mA}$
R	11.0	17.6		
S	15.0	24.0		
T	21.0	34.0		
U	30.0	48.0		

Typical Electro-Optical Characteristics Curves

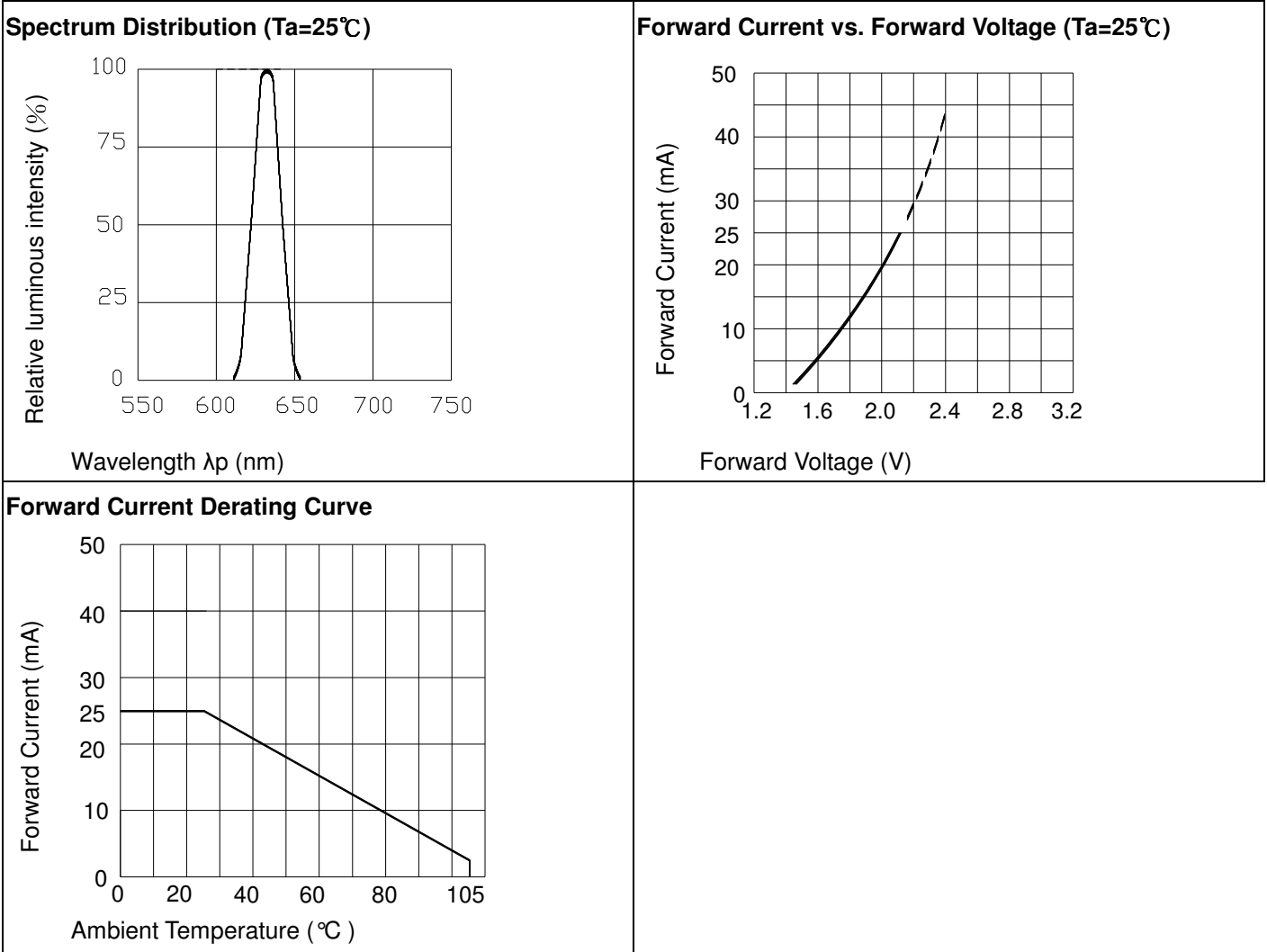

Package Dimension & Internal Circuit Diagram

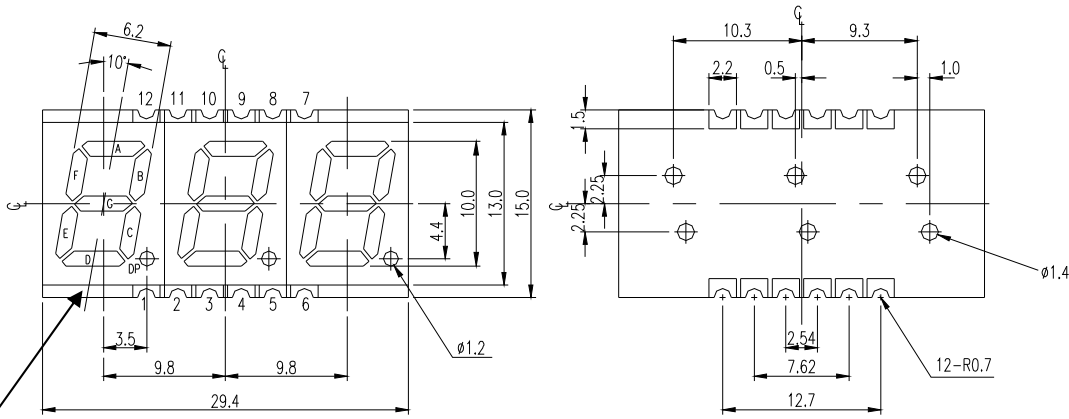

EADXXX
 Date Bin

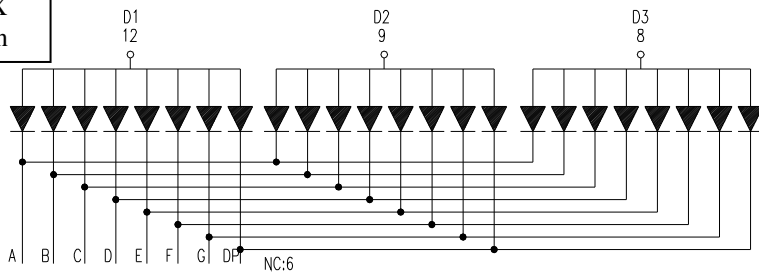

- INTERNAL CONNECTION DIAGRAM
- 1 CATHODE E
 - 2 CATHODE D
 - 3 CATHODE DP
 - 4 CATHODE C
 - 5 CATHODE G
 - 6 NO CONNECT
 - 7 CATHODE B
 - 8 COMMON ANODE D3
 - 9 COMMON ANODE D2
 - 10 CATHODE F
 - 11 CATHODE A
 - 12 COMMON ANODE D1

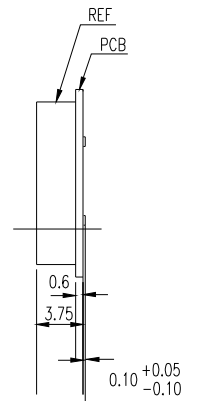

Note: Tolerances unless mentioned $\pm 0.25\text{mm}$. Unit = mm

Packing Materials

Label Explanation

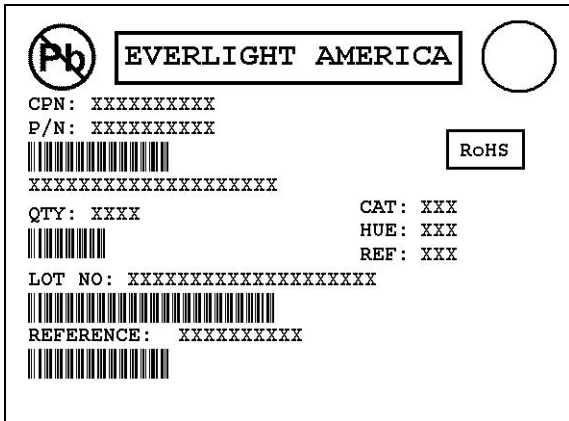

- CPN: Customer's Product Number
- P/N: Product Number
- QTY: Packing Quantity
- CAT: Luminous Intensity Rank
- HUE: Reference
- REF: Reference
- LOT No: Lot Number
- DC: Year and Weekly
- REFERENCE: Volume Label code

Reel Dimensions

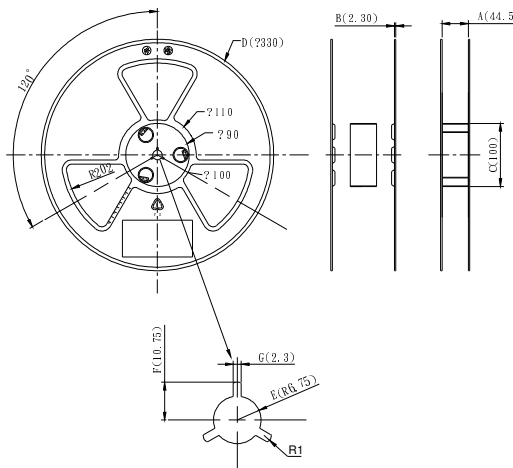

Carrier Tape Dimensions: Loaded Quantity 700 PCS Per Reel

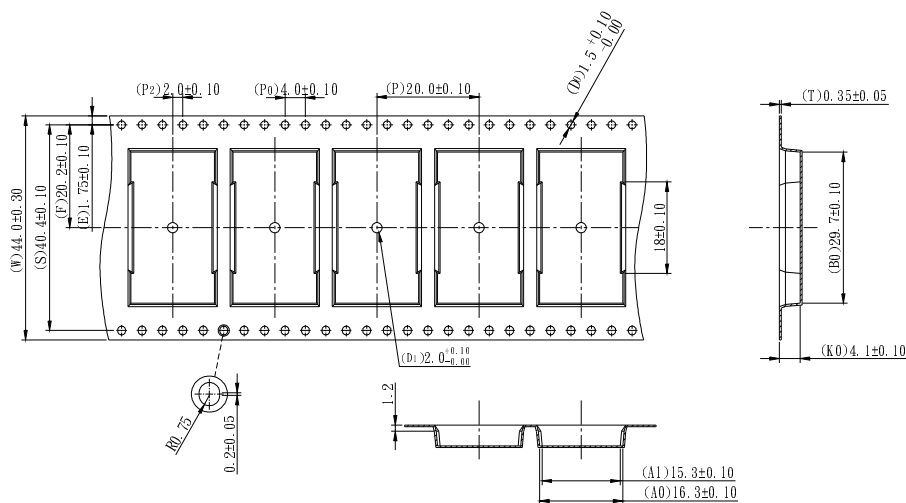

Note: Tolerances unless mentioned ± 0.25 mm. Unit = mm

Packing Process

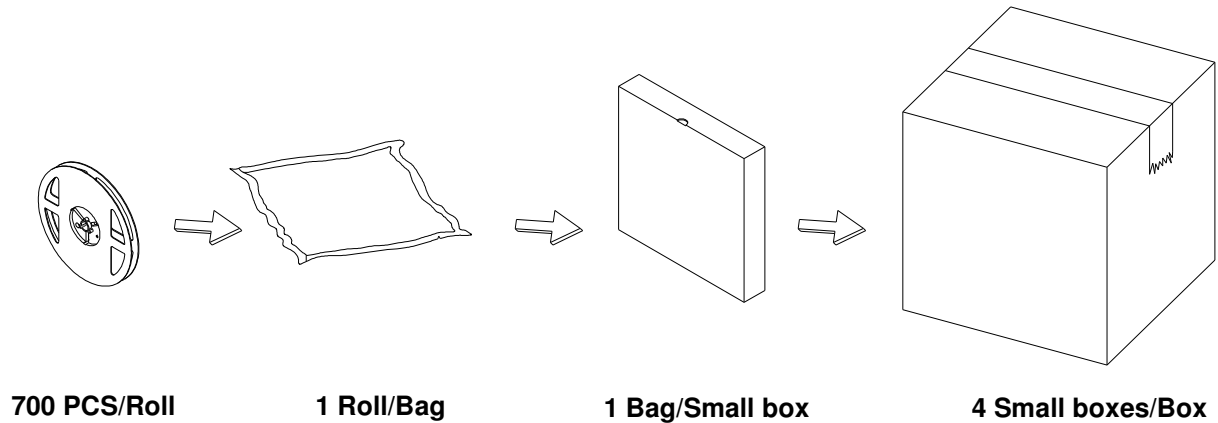

Precautions for Use

1. Soldering Condition

1.1 (A) Maximum Body Case Temperature Profile for evaluation of Reflow Profile

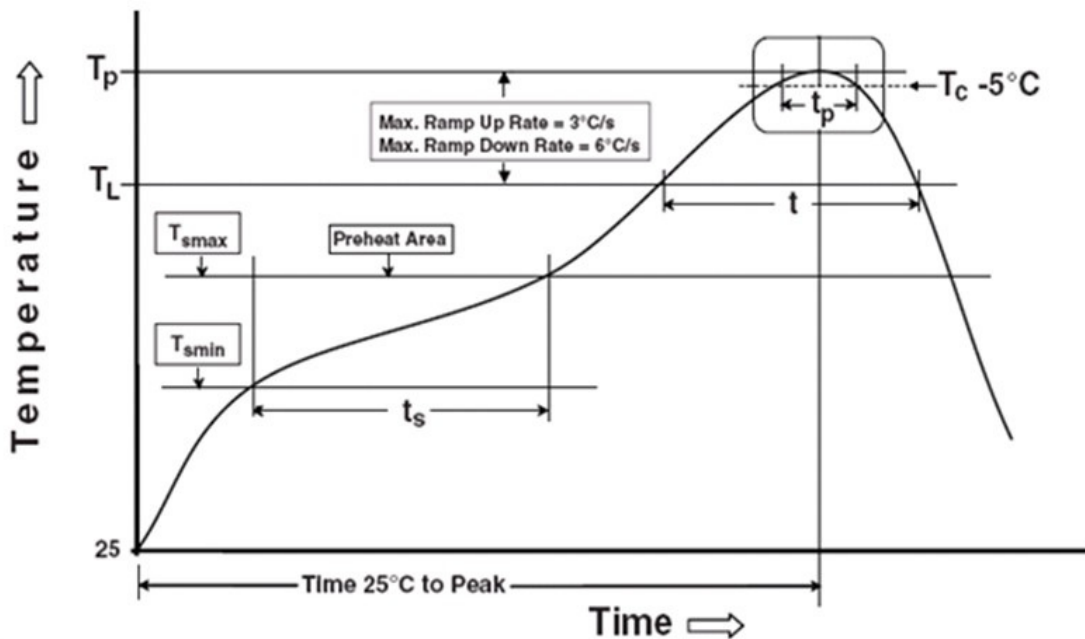

Note:

Reference: IPC/JEDEC J-STD-020D

Preheat

Temperature min (T_{smin})	150 °C
Temperature max (T_{smax})	200 °C
Time (T_{smin} to T_{smax}) (t_s)	60-120 seconds
Average ramp-up rate (T_{smax} to T_p)	3 °C/second max.

Other

Liquidus Temperature (T_L)	217 °C
Time above Liquidus Temperature (t_L)	60-150 seconds
Peak Temperature (T_P)	260 °C
Time within 5 °C of Actual Peak Temperature: $T_P - 5^\circ\text{C}$	30 seconds
Ramp- Down Rate from Peak Temperature	6 °C/second max.
Time 25 °C to peak temperature	8 minutes max.
Reflow times	1 time

All parameters are maximum body case temperature values and cannot be considered as a soldering profile. The body case temperature was measured by soldering a thermal couple to the soldering point of LEDs.

1.2 (B) Recommend soldering pad

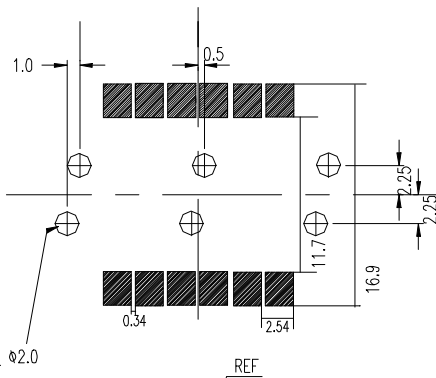

Note: Suggested pad dimension is just for reference only. Please modify the pad dimension based on individual need.

Application Restrictions

1. specification described in this document. Above specification may be changed without notice. EVERLIGHT Americas will reserve authority on material change for above specification.
2. When using this product, please observe the absolute maximum ratings and the instructions for using outlined in these specification sheets. EVERLIGHT Americas assumes no responsibility for any damage resulting from use of the product which does not comply with the absolute maximum ratings and the instructions included in these specification sheets.
3. These specification sheets include materials protected under copyright of EVERLIGHT Americas Corporation. Please don't reproduce or cause anyone to reproduce them without EVERLIGHT Americas' consent.
4. ESD (Electrostatic Discharge)
 - The products are sensitive to static electricity or surge voltage. ESD can damage a die and its reliability. When handling the products, the following measures against electrostatic discharge are strongly recommended:
 - Eliminating the charge
 - Grounded wrist strap, ESD footwear, clothes, and floors

Grounded workstation equipment and tools

ESD table/shelf mat made of conductive materials

- Proper grounding is required for all devices, equipment, and machinery used in product assembly. Surge protection should be considered when designing of commercial products.
- If tools or equipment contain insulating materials such as glass or plastic, the following measures against electrostatic discharge are strongly recommended:
 - Dissipating static charge with conductive materials
 - Preventing charge generation with moisture
 - Neutralizing the charge with ionizers

5. The LEDs should be operated with forward bias. The driving circuit must be designed so that the LEDs are not subjected to forward or reverse voltage while it is off. If reverse voltage is continuously applied to the LEDs, it may cause migration resulting in LED damage.