

MDE Semiconductor, Inc.

201 Shipyard Way, Unit C, Newport Beach, CA., USA 92663 Tel : 760-564-8656 • Fax : 760-564-2414
1-800-831-4881 Email: sales@mdesemiconductor.com Web: www.mdesemiconductor.com

MP4KE SERIES

GLASS PASSIVATED JUNCTION TRANSIENT VOLTAGE SUPPRESSOR VOLTAGE - 6.8 TO 550 Volts 400 Watt Peak Pulse Power

FEATURES

- Plastic package has Underwriters Laboratory Flammability Classification 94 V-O
- Glass passivated chip junction in DO-41 package
- 400W surge capability at 1ms
- Excellent clamping capability
- Low zener impedance
- Low incremental surge resistance
- Excellent clamping capability
- Fast response time: typically less than 1.0 ps from 0 volts to BV min
- Typical IR less than 1µA above 10V
- High temperature soldering guaranteed: 300°C/10 seconds/ .375", (9.5mm) lead length, 5lbs., (2.3kg) tension

MECHANICAL DATA

Case: JEDEC DO-41 Molded plastic
Terminals: Axial leads, solderable per MIL-STD-750, Method 2026
Polarity: Color band denoted positive end (cathode) except Bipolar
Mounting Position: Any
Weight: 0.012 ounces, 0.3 grams

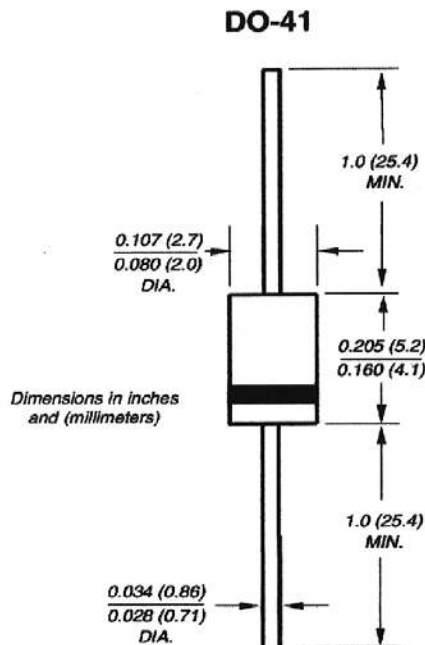

DEVICES FOR BIPOLAR APPLICATIONS

For Bidirectional use C or CA Suffix for types MP4KE6.80 thru types MP4KE550 (e.g. MP4KE6.8C, P4KE550CA) Electrical characteristics apply in both directions.

MAXIMUM RATINGS AND CHARACTERISTICS

Ratings at 25°C ambient temperature unless otherwise specified.

Single phase, half wave, 60Hz, resistive or inductive load.

For Capacitive load, derate current by 20%

RATING	SYMBOL	VALUE	UNITS
Peak Pulse Power Dissipation at TA = 25 °C, TP = 1ms (NOTE 1)	P _{PPM}	Minimum 400	Watts
Peak Pulse Current of on 10/1000 µs waveform (Note 1)	I _{PPM}	SEE TABLE 1	Amps
Steady State Power Dissipation at TL = 75°C Lead lengths .375", 9.5mm (Note 2)	P _{M(AV)}	1.0	Watts
Peak Forward Surge Current, 8.3ms Single Half Sine-wave Superimposed on Rated Load, (JEDEC Method)(Note 3)	I _{FSM}	40	Amps
Operatings and Storage Temperature Range	T _J , T _{STG}	-55 +175	°C

NOTES:

1. Non-repetitive current pulse, per Fig.3 and derated above Ta=25 °C per Fig.2.
2. Mounted on Copper Pad area of 1.6x1.6" (40x40mm) per Fig.5.
3. 8.3ms single half sine-wave, or equivalent square wave, Duty cycle=4 pulses per minutes maximum.

Certified RoHS Compliant

UL File # E223026

MDE Semiconductor, Inc.

201 Shipyard Way, Unit C, Newport Beach, CA., USA 92663 Tel : 760-564-8656 • Fax : 760-564-2414
 1-800-831-4881 Email: sales@mdesemiconductor.com Web: www.mdesemiconductor.com

RATING AND CHARACTERISTIC CURVES MP4KE SERIES

Fig. 1 - Peak Pulse Power Rating

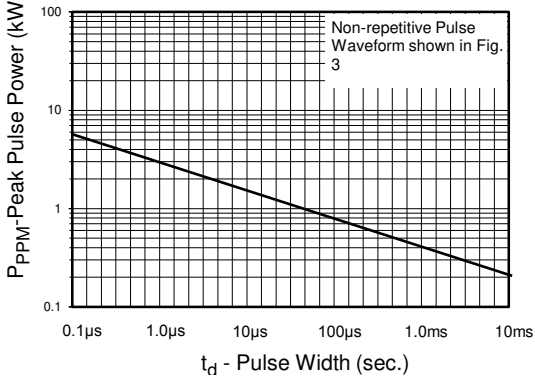

Fig.2 - Pulse Derating Curve

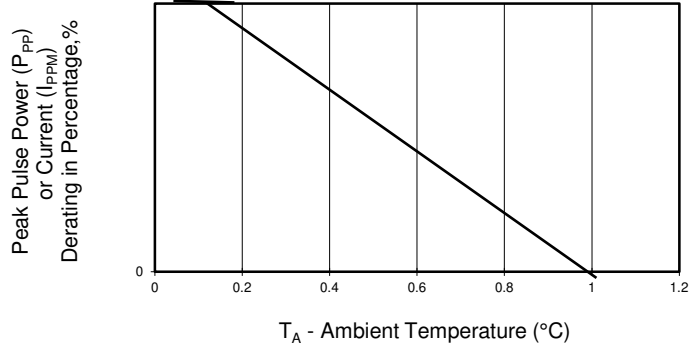

Fig.3 - Pulse Waveform

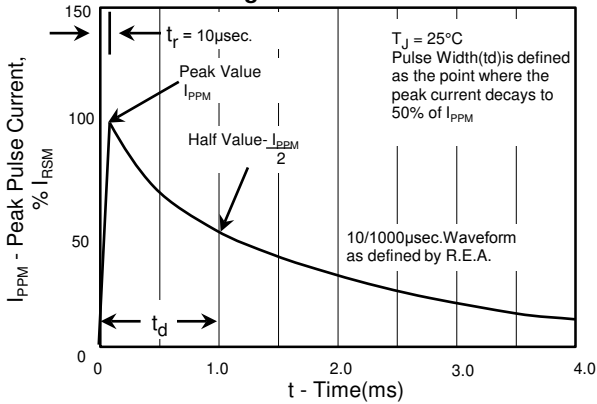

Fig.4 - Typ. Junction Capacitance Uni-Directional

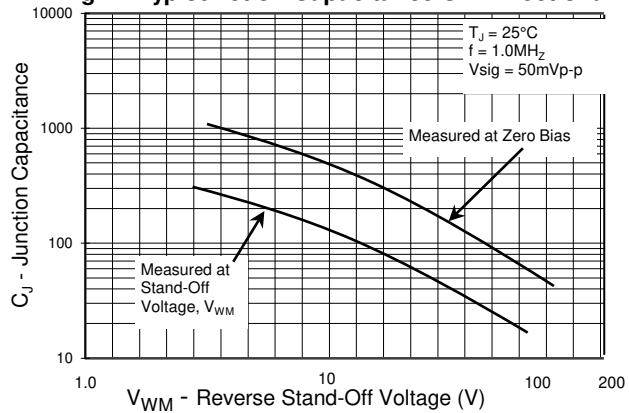

Fig.5 - steady State Power Derating Curve

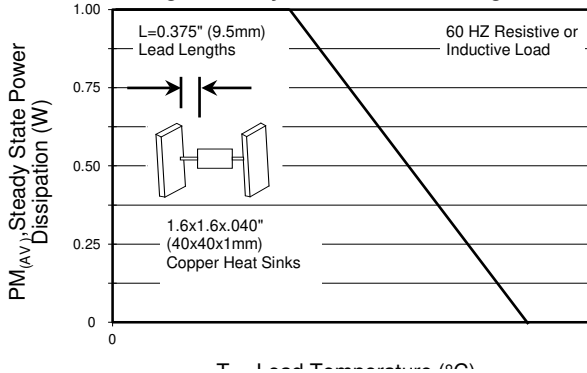

Fig.6 - Maximum Non-Repetitive Forward Surge Current Uni-Directional Only

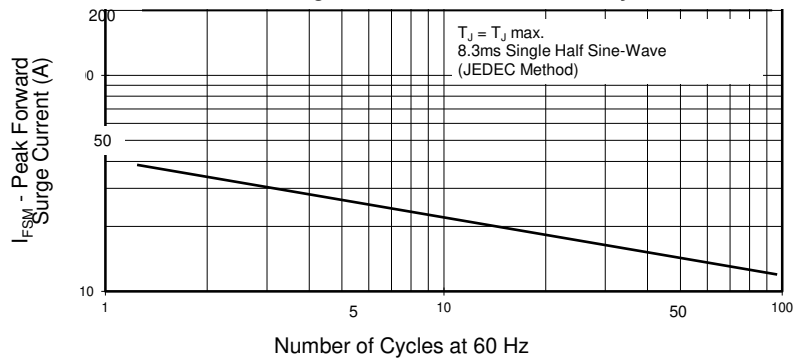

Fig.7 - Typical Reverse Leakage Characteristics

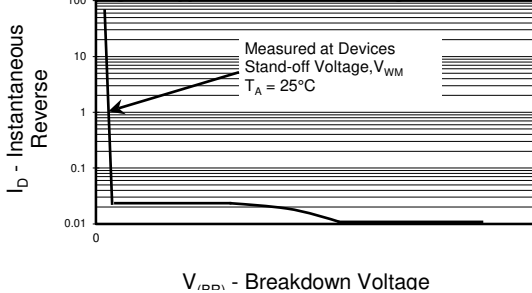
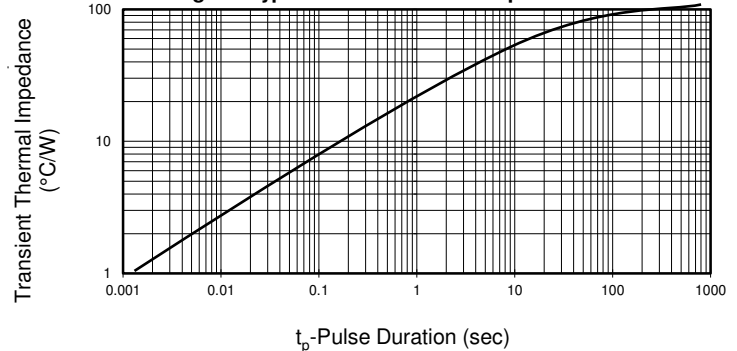

Fig. 8 - Typ. Transient Thermal Impedance



MDE Semiconductor, Inc.

201 Shipyard Way, Unit C, Newport Beach, CA., USA 92663 Tel : 760-564-8656 • Fax : 760-564-2414
1-800-831-4881 Email: sales@mdesemiconductor.com Web: www.mdesemiconductor.com

400 Watt TVS

UNI-POLAR	BI-POLAR	REVERSE STANDOFF VOLTAGE V_{RWM} (V)	BREAKDOWN VOLTAGE V_{BR} (V) MIN. @ I_T	BREAKDOWN VOLTAGE V_{BR} (V) MAX. @ I_T	TEST CURRENT (I_T) mA	MAXIMUM CLAMPING VOLTAGE @ I_{PP} V_C (V)	PEAK PULSE CURRENT I_{PP} (A)	REVERSE LEAKAGE @ V_{RWM} I_R (μ A)
MP4KE6.8A	MP4KE6.8CA	5.80	6.45	7.14	10	10.5	39.0	1000
MP4KE7.5A	MP4KE7.5CA	6.40	7.13	7.88	10	11.3	36.3	500
MP4KE8.2A	MP4KE8.2CA	7.02	7.79	8.61	10	12.1	33.9	200
MP4KE9.1A	MP4KE9.1CA	7.78	8.65	9.55	10	13.4	30.6	50
MP4KE10A	MP4KE10CA	8.55	9.50	10.50	1	14.5	28.3	10
MP4KE11A	MP4KE11CA	9.40	10.50	11.60	1	15.6	26.3	5
MP4KE12A	MP4KE12CA	10.20	11.40	12.60	1	16.7	24.6	5
MP4KE13A	MP4KE13CA	11.10	12.40	13.70	1	18.2	22.5	5
MP4KE15A	MP4KE15CA	10.00	14.30	15.80	1	21.2	19.3	5
MP4KE16A	MP4KE16CA	12.90	15.20	16.80	1	22.5	18.2	5
MP4KE18A	MP4KE18CA	14.50	17.10	18.90	1	25.2	16.1	5
MP4KE20A	MP4KE20CA	17.10	19.00	21.00	1	27.7	14.8	5
MP4KE22A	MP4KE22CA	18.80	20.90	23.10	1	30.6	13.4	5
MP4KE24A	MP4KE24CA	20.50	22.80	25.20	1	33.2	12.3	5
MP4KE27A	MP4KE27CA	23.10	25.70	28.40	1	37.5	10.9	5
MP4KE30A	MP4KE30CA	25.60	28.50	31.50	1	41.4	9.9	5
MP4KE33A	MP4KE33CA	28.20	31.40	34.70	1	45.7	9.0	5
MP4KE36A	MP4KE36CA	30.80	34.20	37.80	1	49.9	8.2	5
MP4KE39A	MP4KE39CA	33.30	37.10	41.00	1	53.9	7.6	5
MP4KE43A	MP4KE43CA	36.80	40.90	45.20	1	59.3	6.9	5
MP4KE47A	MP4KE47CA	40.20	44.70	49.40	1	64.8	6.3	5
MP4KE51A	MP4KE51CA	43.60	48.50	53.60	1	70.1	5.8	5
MP4KE56A	MP4KE56CA	47.80	53.20	58.80	1	77.0	5.3	5
MP4KE62A	MP4KE62CA	53.00	58.90	65.10	1	85.0	4.8	5
MP4KE68A	MP4KE68CA	58.10	64.60	71.40	1	92.0	4.5	5
MP4KE75A	MP4KE75CA	64.10	71.30	78.80	1	103.0	4.0	5
MP4KE82A	MP4KE82CA	70.10	77.90	86.10	1	113.0	3.6	5
MP4KE91A	MP4KE91CA	77.80	86.50	95.50	1	125.0	3.3	5
MP4KE100A	MP4KE100CA	85.50	95.00	105.00	1	137.0	3.0	5
MP4KE110A	MP4KE110CA	94.00	105.00	116.00	1	152.0	2.7	5
MP4KE120A	MP4KE120CA	102.00	114.00	126.00	1	165.0	2.5	5
MP4KE130A	MP4KE130CA	111.00	124.00	137.00	1	179.0	2.3	5
MP4KE150A	MP4KE150CA	128.00	143.00	158.00	1	207.0	2.0	5
MP4KE160A	MP4KE160CA	136.00	152.00	168.00	1	219.0	1.9	5
MP4KE170A	MP4KE170CA	145.00	162.00	179.00	1	234.0	1.8	5
MP4KE180A	MP4KE180CA	154.00	171.00	189.00	1	246.0	1.7	5
MP4KE200A	MP4KE200CA	171.00	190.00	210.00	1	274.0	1.5	5
MP4KE220A	MP4KE220CA	185.00	209.00	231.00	1	328.0	1.3	5
MP4KE250A	MP4KE250CA	214.00	237.00	263.00	1	344.0	1.2	5
MP4KE300A	MP4KE300CA	256.00	285.00	315.00	1	414.0	1.0	5
MP4KE350A	MP4KE350CA	300.00	332.00	368.00	1	482.0	0.85	5
MP4KE400A	MP4KE400CA	342.00	380.00	420.00	1	548.0	0.75	5
MP4KE440A	MP4KE440CA	376.00	418.00	462.00	1	602.0	0.68	5
MP4KE480A	MP4KE480CA	408.00	456.00	504.00	1	658.0	0.61	5
MP4KE510A	MP4KE510CA	434.00	485.00	535.00	1	698.0	0.57	5
MP4KE530A	MP4KE530CA	450.00	503.50	556.50	1	725.0	0.55	5
MP4KE540A	MP4KE540CA	459.00	513.00	567.00	1	740.0	0.54	5
MP4KE550A	MP4KE550CA	467.00	522.50	577.50	1	760.0	0.52	5

For bidirectional type having V_{RWM} of 10 volts and less, the I_R limit is double.

For parts without A, the V_{BR} is $\pm 10\%$

Certified RoHS Compliant
UL File # E223026

2/10/2022