

# UWB: 6.24 – 8.24 GHz SMD LTCC Filter



**ABSGS4C7-CDGM3B8M**

Request Samples



Check Inventory



2.00 x 1.25 x 0.95mm  
RoHS Compliant  
MSL Level = 1

## Features

- Wide Band BPF
- Low loss of 2.5 dB
- Compact package size
- Max power rating of 3W
- Group delay < 2 ns

## Applications

- UWB (Ultra-Wide Band)
- IoT
- M2M
- Secure car access
- Item Tracking
- Indoor Navigation
- Hands-Free Payment
- Smart Access
- Object Detection

## Product Image



# UWB: 6.24 – 8.24 GHz SMD LTCC Filter



**ABSGS4C7-CDGM3B8M**

Request Samples



Check Inventory



2.00 x 1.25 x 0.95mm  
RoHS Compliant  
MSL Level = 1

## Electrical Specifications

Parameter	Min	Typical	Max	Unit	Notes
Frequency Range	6240	-----	8240	MHz	-----
Insertion Loss	-----	-----	-2.7	dB	-----
Return Loss	-----	-----	-10	dB	-----
Group Delay Ripple	-----	-----	1.0	ns	-----
Group Delay	-----	-----	3.0	ns	-----
Attenuation	-----	-----	-35 -35 -15 -10 -30	dB	DC ~ 5200 MHz 2400 ~ 2500 MHz 5200 ~ 5860 MHz 9000 ~ 9500 MHz 9500 ~ 18000 MHz
Power Capacity	-----	-----	3	W	-----

## Mechanical Specifications

Parameters	Specifications
Filter Dimension	2.00 x 1.25 x 0.95 mm
Mounting Type	SMD Mount
Material Type	Dielectric Filter
Technology	LTCC
In/Output Terminals	Ag + Ni + Sn
Ground Base	Ag+ Ni + Sn

## Environmental Specifications

Parameters	Specifications
Operating Temperature Range	-40°C ~ +105 °C
Storage Temperature Range	-40°C ~ +105 °C
MSL level	1
ESD	N/A
Temperature range	25±5 °C
Relative Humidity range	90~95%RH & <85%RH



5101 Hidden Creek Ln Spicewood TX 78669  
Phone: 512-371-6159 | Fax: 512-351-8858  
For terms and conditions of sales, please visit:  
[www.abracon.com](http://www.abracon.com)

REVISED: 09-23-22

ABRACON IS  
ISO9001-2015  
CERTIFIED

# UWB: 6.24 – 8.24 GHz SMD LTCC Filter



**ABSGS4C7-CDGM3B8M**

Request Samples



Check Inventory



2.00 x 1.25 x 0.95mm  
**RoHS Compliant**  
 MSL Level = 1

## Package Dimensions

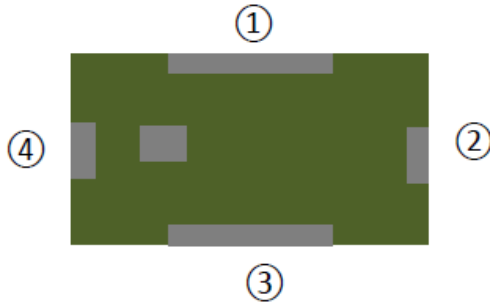

Number	Terminal Name
①	GND
②	OUT
③	GND
④	IN

( Top View )

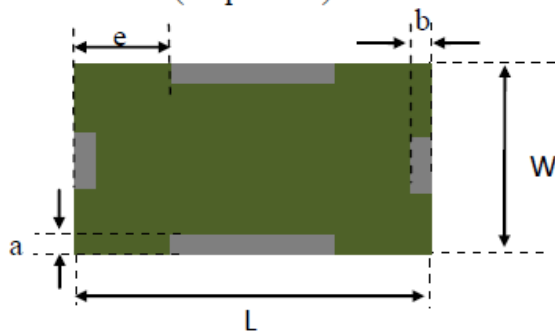

( Bottom View )

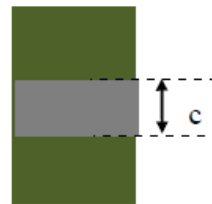

( Side View )

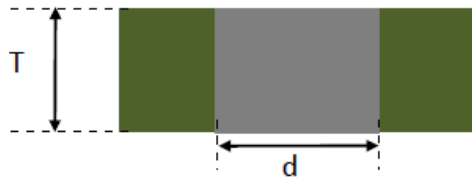

( Side View )

Symbol	L	W	T	a	b	c	d	e
Dimension (mm)	2.0±0.15	1.25±0.10	0.95±0.10	0.25±0.10	0.25±0.1	0.3±0.10	1.3±0.10	0.35±0.10

# UWB: 6.24 – 8.24 GHz SMD LTCC Filter



**ABSGS4C7-CDGM3B8M**

Request Samples



Check Inventory



2.00 x 1.25 x 0.95mm  
RoHS Compliant  
MSL Level = 1

## Footprint

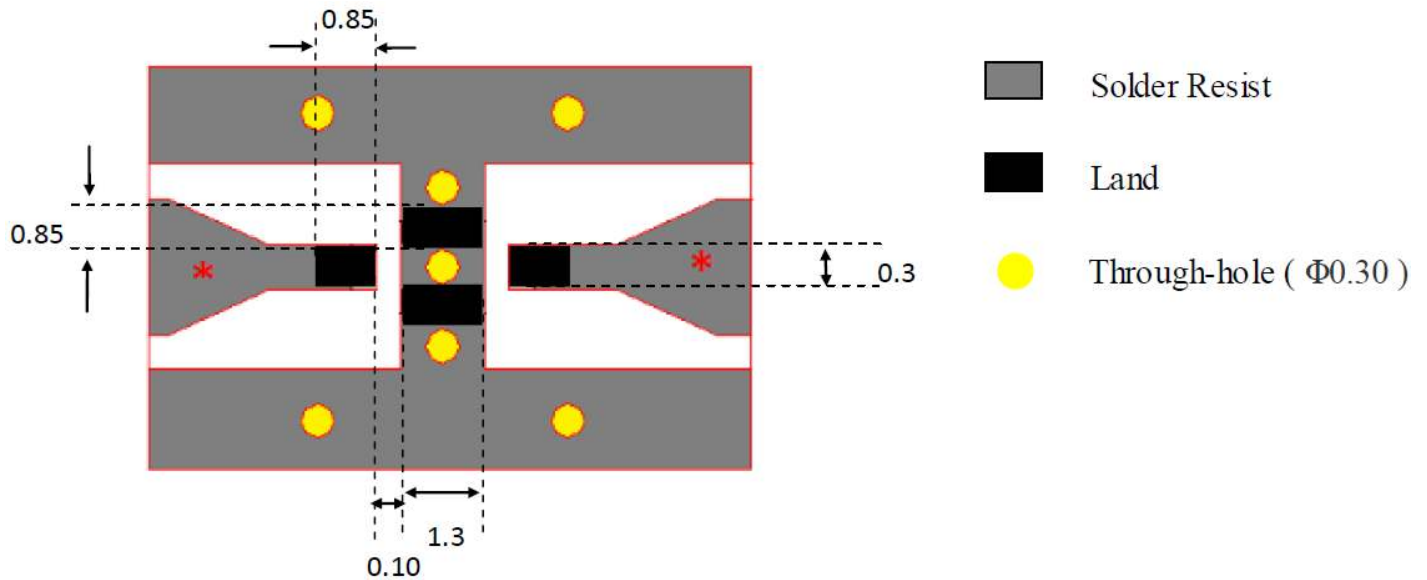

\*Note: Line Width Should be designed to match 50  $\Omega$  characteristic impedance, depending on PCB material and thickness

Unit: mm

# UWB: 6.24 – 8.24 GHz SMD LTCC Filter



**ABSGS4C7-CDGM3B8M**

Request Samples



Check Inventory



2.00 x 1.25 x 0.95mm  
RoHS Compliant  
MSL Level = 1

## Impedance Characteristics [Narrowband]

**S-parameters**

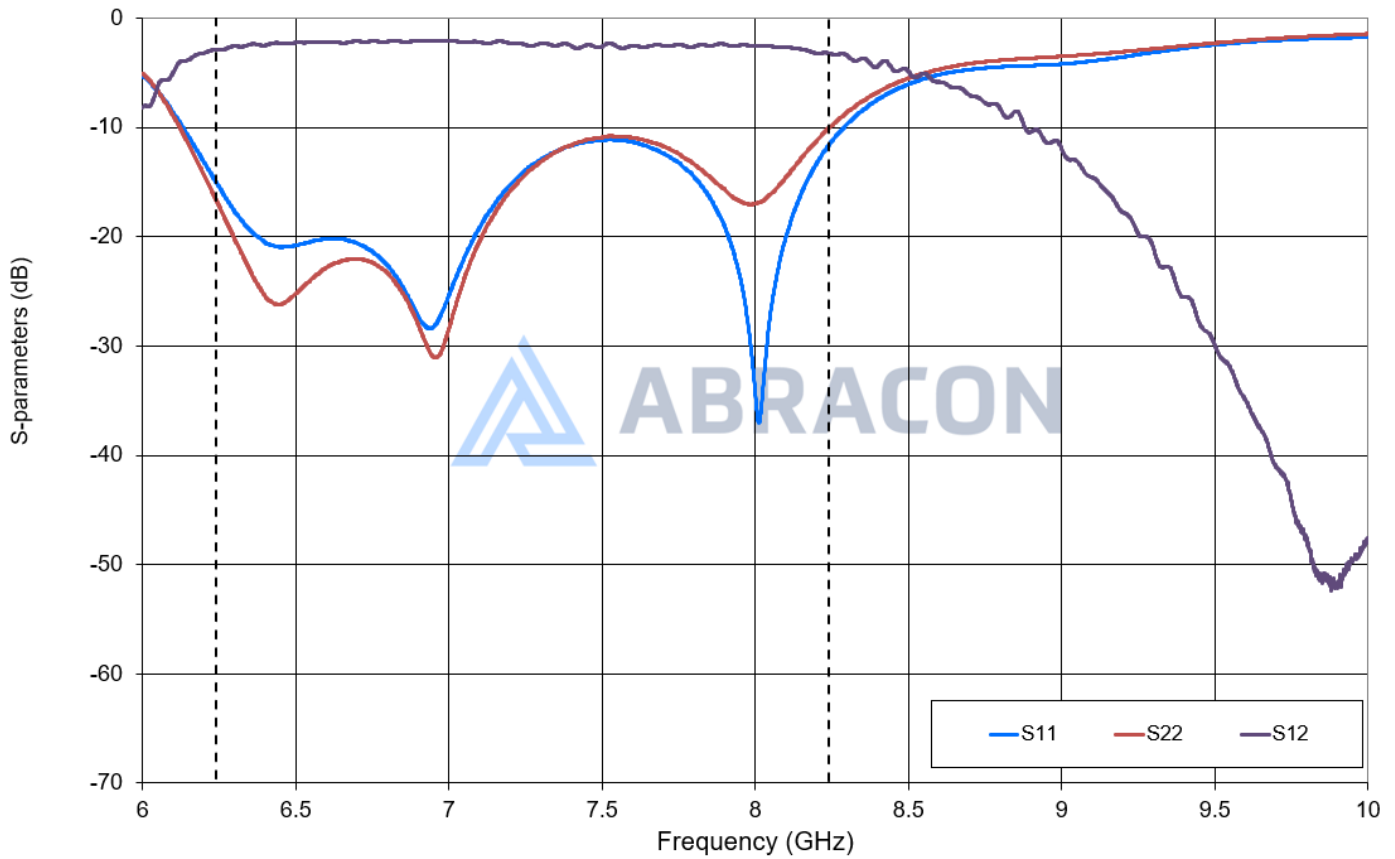

# UWB: 6.24 – 8.24 GHz SMD LTCC Filter



**ABSGS4C7-CDGM3B8M**

Request Samples



Check Inventory



2.00 x 1.25 x 0.95mm  
RoHS Compliant  
MSL Level = 1

## Impedance Characteristics [Wideband]

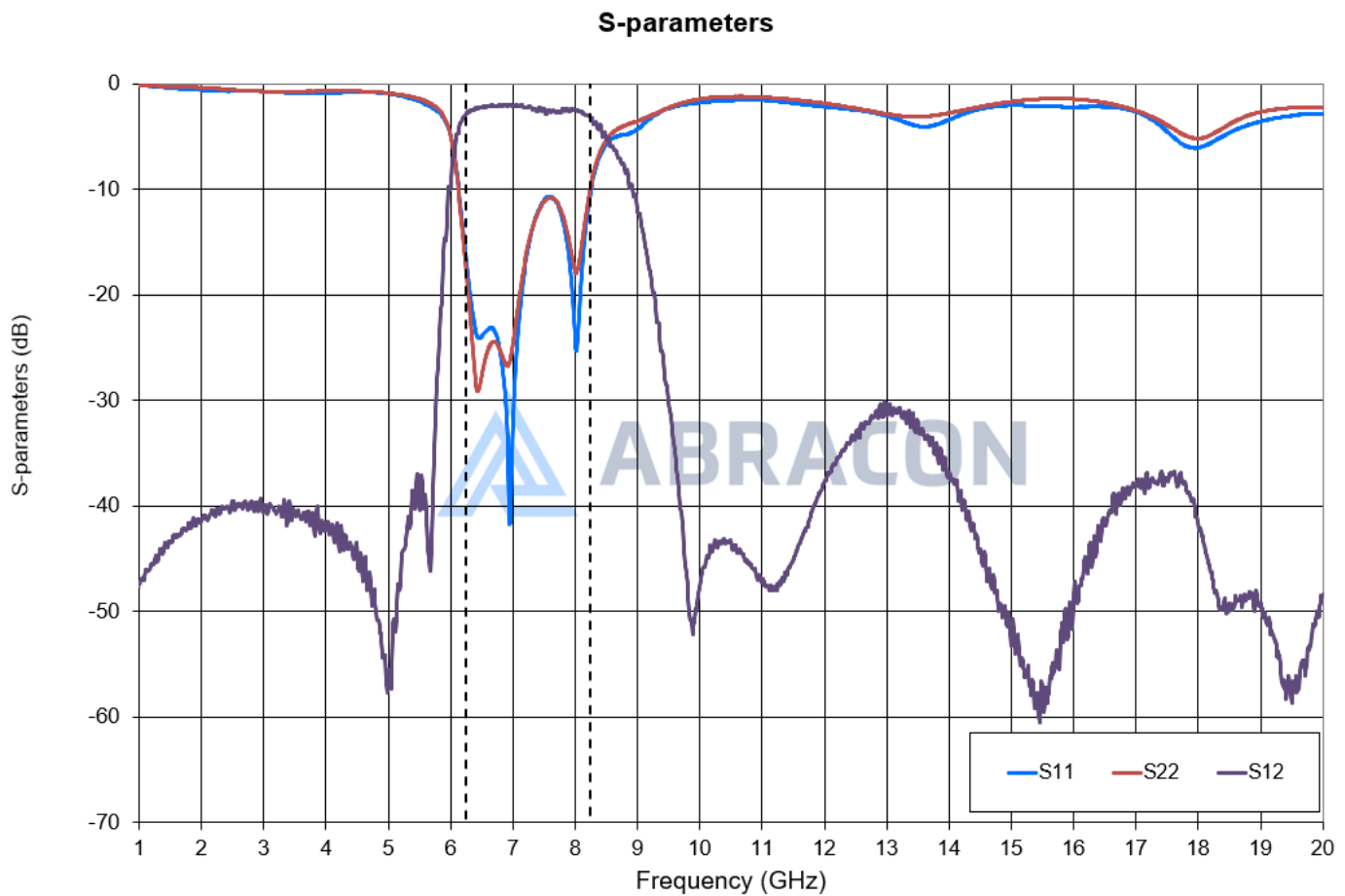

# UWB: 6.24 – 8.24 GHz SMD LTCC Filter



**ABSGS4C7-CDGM3B8M**

Request Samples



Check Inventory



2.00 x 1.25 x 0.95mm  
RoHS Compliant  
MSL Level = 1

## Group Delay Characteristics [Narrowband]

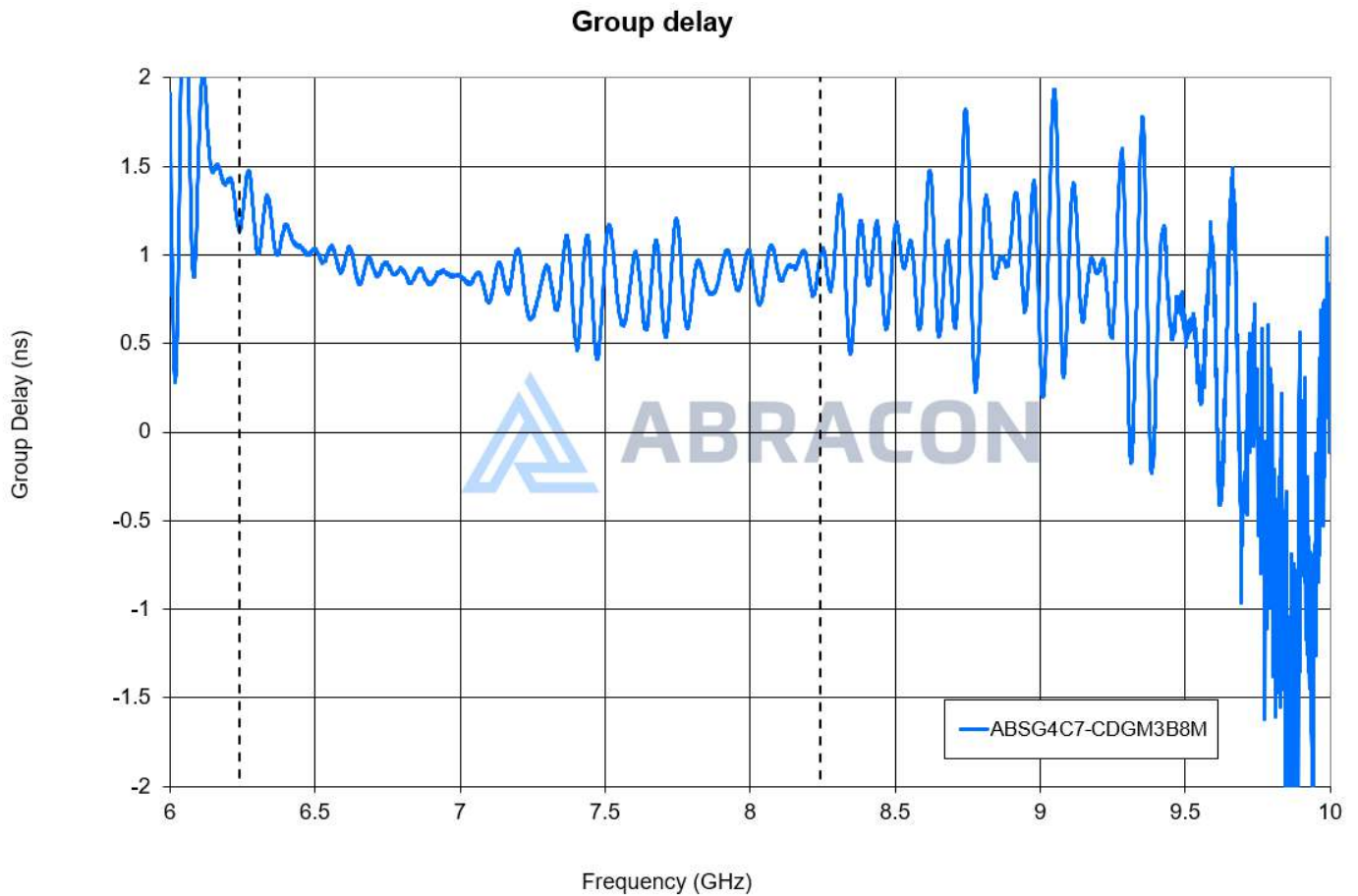

# UWB: 6.24 – 8.24 GHz SMD LTCC Filter



**ABSGS4C7-CDGM3B8M**

Request Samples



Check Inventory



2.00 x 1.25 x 0.95mm  
RoHS Compliant  
MSL Level = 1

## Group Delay Characteristics [Wideband]

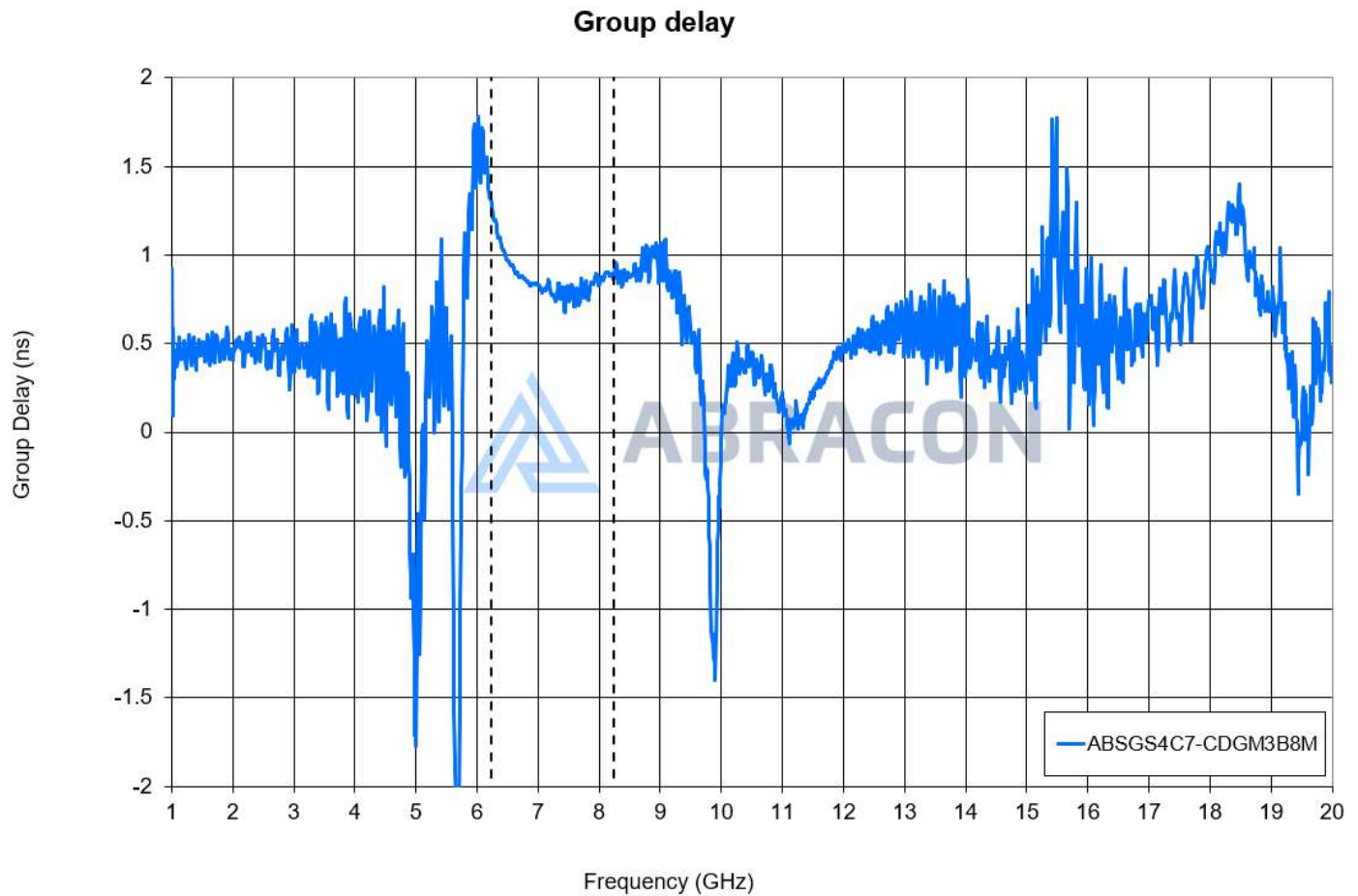



# UWB: 6.24 – 8.24 GHz SMD LTCC Filter



**ABSGS4C7-CDGM3B8M**

Request Samples



Check Inventory



2.00 x 1.25 x 0.95mm  
**RoHS Compliant**  
 MSL Level = 1

## Soldering Profile: Reflow

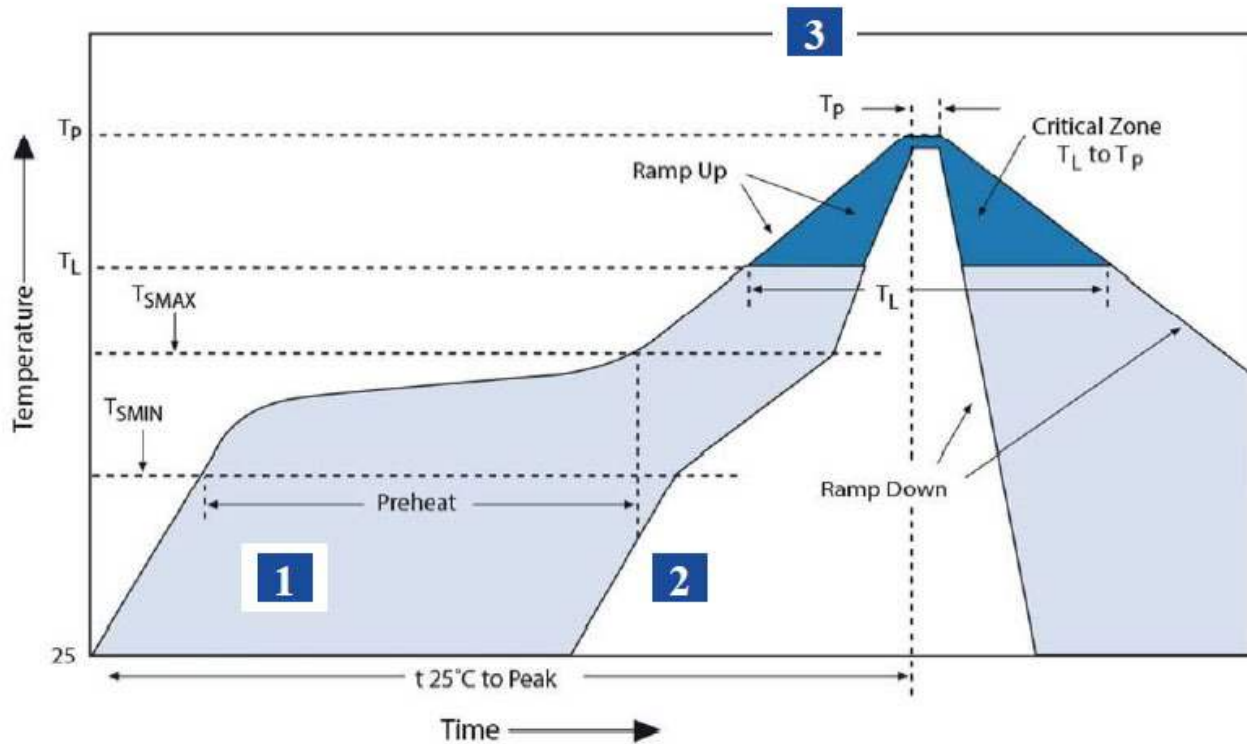

Zone	Description	Temperature	Time
1	Preheat / Soak	$T_{SMIN} \sim T_{SMAX}$ 160 – 180 °C	60 ~ 120 sec
2	Reflow	$T_L$ 220 °C	30~40 sec
3	Peak heat	$T_P$ 265 °C	5 sec (Max)

# UWB: 6.24 – 8.24 GHz SMD LTCC Filter



**ABSGS4C7-CDGM3B8M**

Request Samples



Check Inventory



**2.00 x 1.25 x 0.95mm**  
**RoHS Compliant**  
**MSL Level = 1**

## Packaging and Dimensions

### 1. Plastic Tape

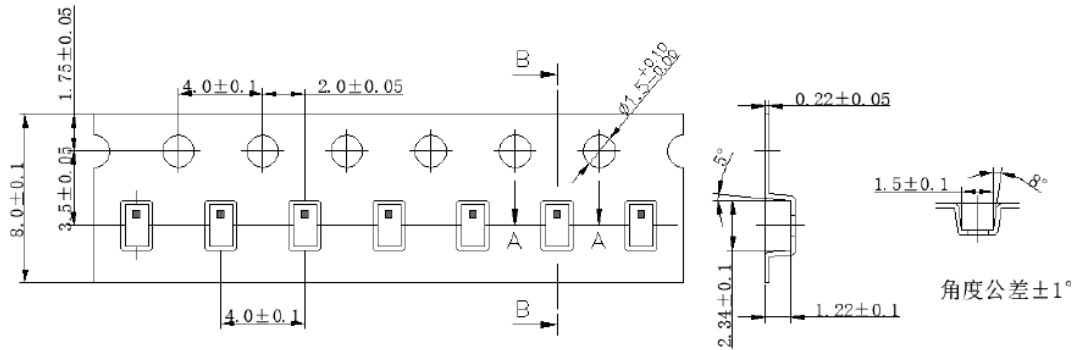

Reserve a length of 200mm for the trailer of the carrier and 200 mm for the leader of the carrier and further 200mm at least of cover tape at the leading part of the carrier.

### 2. Reel (4000 pcs/Reel)

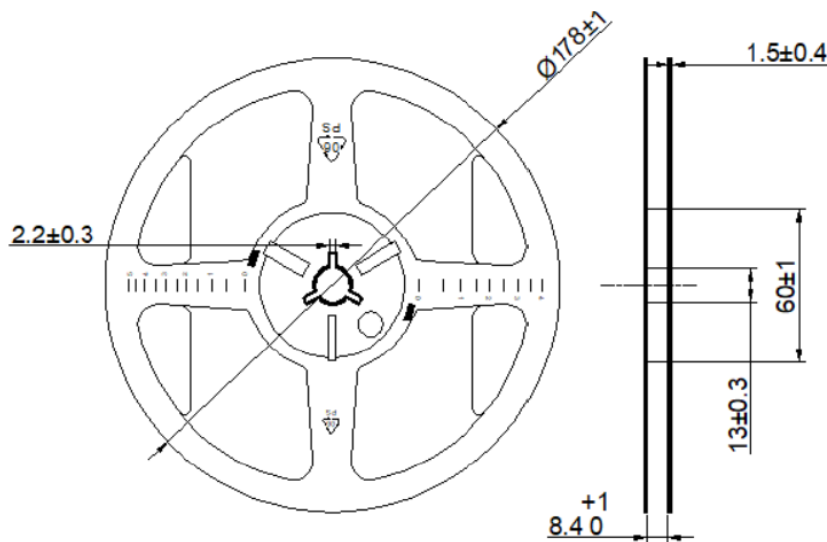

**ATTENTION:** Abracon LLC's products are COTS – Commercial-Off-The-Shelf products; suitable for Commercial, Industrial and, where designated, Automotive Applications. Abracon's products are not specifically designed for Military, Aviation, Aerospace, Life-dependent Medical applications or any application requiring high reliability where component failure could result in loss of life and/or property. For applications requiring high reliability and/or presenting an extreme operating environment, written consent and authorization from Abracon LLC is required. Please contact Abracon LLC for more information.



5101 Hidden Creek Ln Spicewood TX 78669  
 Phone: 512-371-6159 | Fax: 512-351-8858  
 For terms and conditions of sales, please visit:  
[www.abracon.com](http://www.abracon.com)

**REVISED: 09-23-22**

ABRACON IS  
 ISO9001-2015  
 CERTIFIED