

Low voltage complementary power Darlington transistors

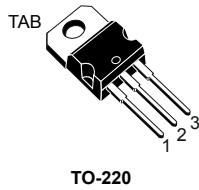

Features

- Low collector-emitter saturation voltage
- Complementary NPN - PNP transistors

Application

- General purpose linear and switching

Description

The devices are manufactured in planar technology with “base island” layout and monolithic Darlington configuration. The resulting transistors show exceptional high gain performance coupled with very low saturation voltage.

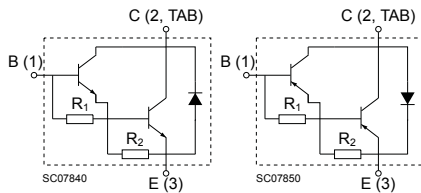

NPN: $R_1 = 7 \text{ k}\Omega$, $R_2 = 70 \Omega$ PNP: $R_1 = 16 \text{ k}\Omega$, $R_2 = 60 \Omega$



Product status links

[TIP120](#)

[TIP121](#)

[TIP122](#)

[TIP125](#)

[TIP127](#)

1 Electrical ratings

Table 1. Absolute maximum ratings

Symbol	Parameter	Value				Unit
		NPN	TIP120	TIP121	TIP122	
		PNP	TIP125		TIP127	
V_{CBO}	Collector-base voltage ($I_E = 0$ A)		60	80	100	V
V_{CEO}	Collector-emitter voltage ($I_B = 0$ A)		60	80	100	V
V_{EBO}	Collector-base voltage ($I_C = 0$ A)		5			V
I_C	Collector current		5			A
I_{CM}	Collector peak current		8			A
I_B	Base current		0.12			A
P_{TOT}	Total power dissipation at $T_C \leq 25^\circ\text{C}$		65			W
	Total power dissipation at $T_A \leq 25^\circ\text{C}$		2			
T_{stg}	Storage temperature range		-65 to 150			$^\circ\text{C}$
T_J	Maximum operating junction temperature		150			$^\circ\text{C}$

Note: For PNP types voltage and current values are negative.

Table 2. Thermal data

Symbol	Parameter	Value	Unit
R_{thJC}	Thermal resistance, junction-to-case	1.92	$^\circ\text{C}/\text{W}$
R_{thJA}	Thermal resistance, junction-to-ambient	62.5	$^\circ\text{C}/\text{W}$

2 Electrical characteristics

$T_C = 25^\circ\text{C}$ unless otherwise specified.

Table 3. Electrical characteristics

Symbol	Parameter	Test conditions	Min.	Typ.	Max.	Unit
I_{CEO}	Collector cut-off current	$I_B = 0\text{ A}, V_{CE} = 30\text{ V}$ for TIP120/125		-	0.5	mA
		$I_B = 0\text{ A}, V_{CE} = 40\text{ V}$ for TIP121		-	0.5	
		$I_B = 0\text{ A}, V_{CE} = 50\text{ V}$ for TIP122/127		-	0.5	
I_{CBO}	Collector cut-off current	$I_B = 0\text{ A}, V_{CE} = 60\text{ V}$ for TIP120/125		-	0.2	mA
		$I_B = 0\text{ A}, V_{CE} = 80\text{ V}$ for TIP121		-	0.2	
		$I_B = 0\text{ A}, V_{CE} = 100\text{ V}$ for TIP122/127		-	0.2	
I_{EBO}	Emitter cut-off current	$I_C = 0\text{ A}, V_{EB} = 5\text{ V}$		-	2	mA
$V_{CEO(sus)}^{(1)}$	Collector-emitter sustaining voltage	$I_B = 0\text{ A}, I_C = 30\text{ mA}$ for TIP120/125	60	-		V
		$I_B = 0\text{ A}, I_C = 30\text{ mA}$ for TIP121	80	-		
		$I_B = 0\text{ A}, I_C = 30\text{ mA}$ for TIP122/127	100	-		
$V_{CE(sat)}^{(1)}$	Collector-emitter saturation voltage	$I_C = 3\text{ A}, I_B = 12\text{ mA}$		-	2	V
		$I_C = 5\text{ A}, I_B = 20\text{ mA}$		-	4	
$V_{BE(on)}^{(1)}$	Base-emitter on voltage	$I_C = 3\text{ A}, V_{CE} = 3\text{ V}$		-	2.5	V
$h_{FE}^{(1)}$	DC current gain	$I_C = 0.5\text{ A}, V_{CE} = 3\text{ V}$	1000	-		
		$I_C = 3\text{ A}, V_{CE} = 3\text{ V}$	1000	-		

1. Pulsed: Pulse duration $\leq 300\ \mu\text{s}$, duty cycle $\leq 2\%$.

Note: For PNP types voltage and current values are negative.

2.1 Electrical characteristics (curves)

Figure 1. Safe operating area

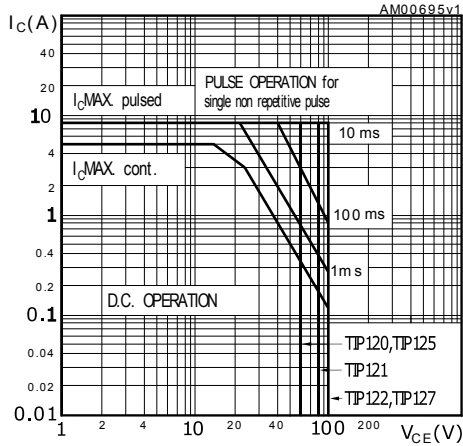

Figure 2. Derating curve

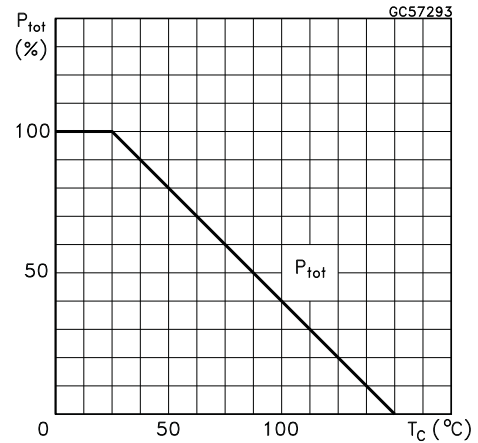

Figure 3. DC current gain (NPN)

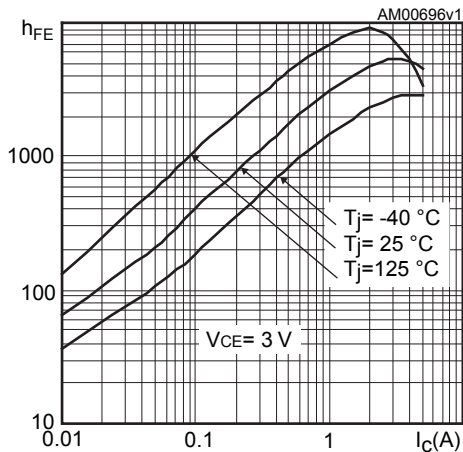

Figure 4. DC current gain (PNP)

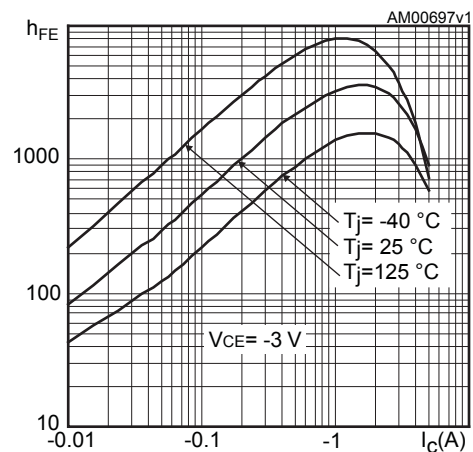

Figure 5. Collector-emitter saturation voltage (NPN)

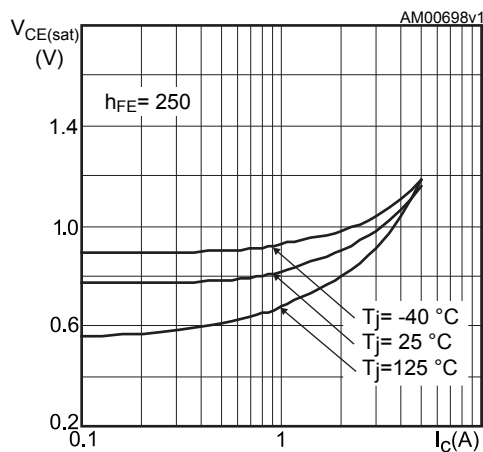

Figure 6. Collector-emitter saturation voltage (PNP)

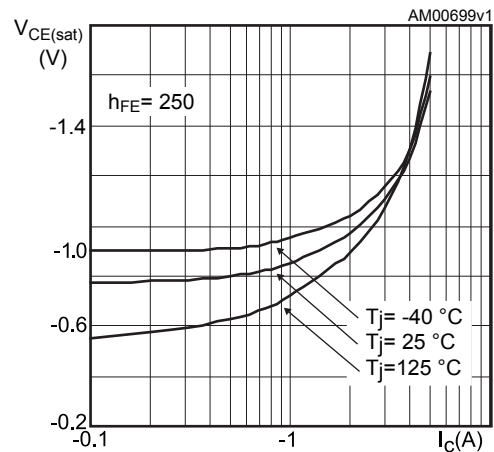

Figure 7. Base-emitter saturation voltage (NPN)

Figure 8. Base-emitter saturation voltage (PNP)

Figure 9. Base-emitter on voltage (NPN)

Figure 10. Base-emitter on voltage (PNP)

Figure 11. Resistive load switching time (NPN, on)

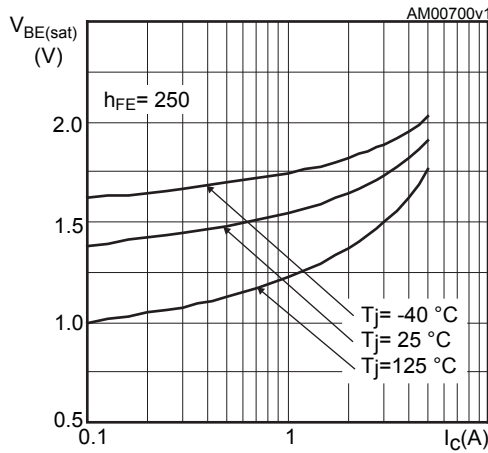
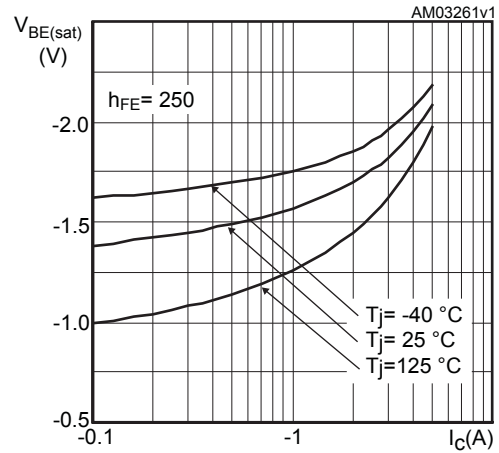
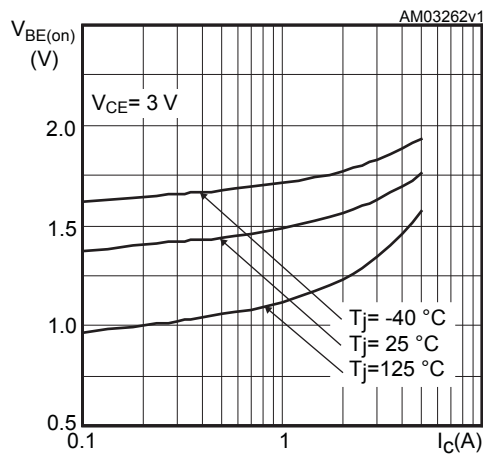
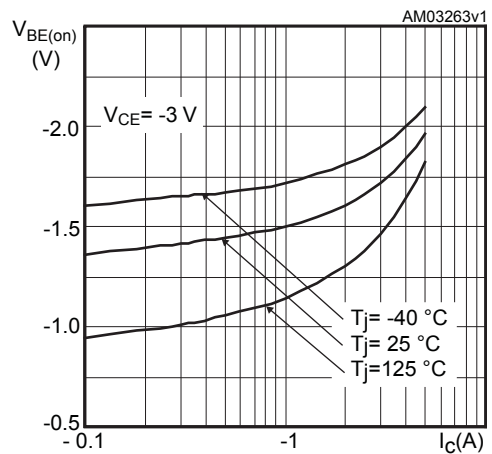
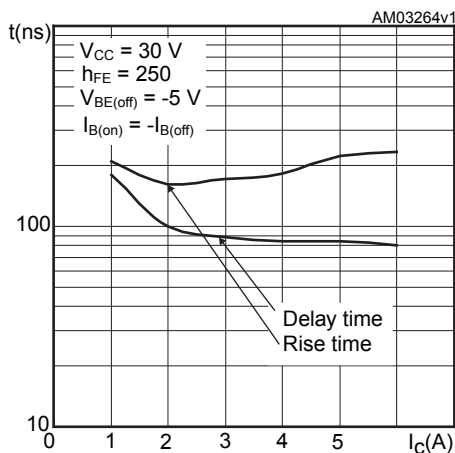
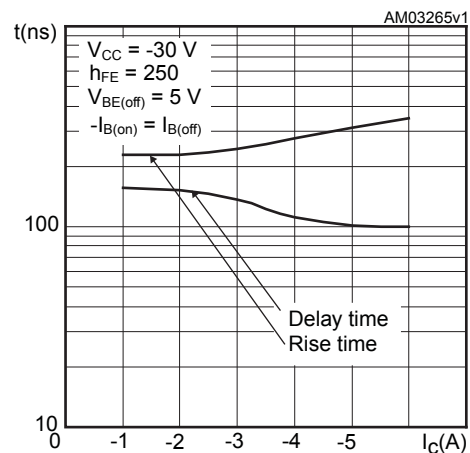
Figure 12. Resistive load switching time (PNP, on)

Figure 13. Resistive load switching time (NPN, off)

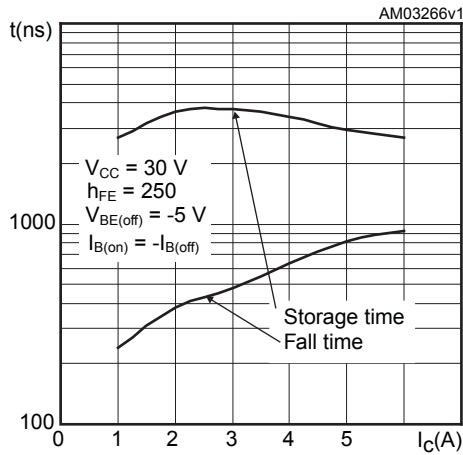

Figure 14. Resistive load switching time (PNP, off)

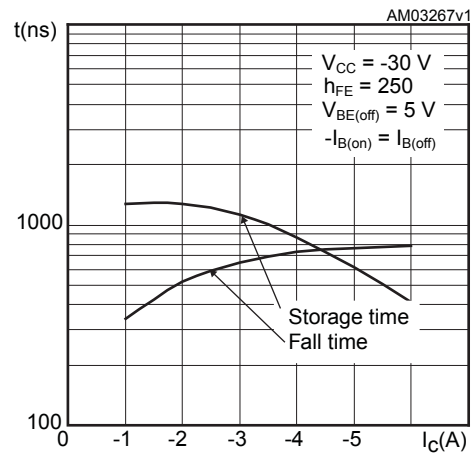

Figure 15. Capacitance characteristics (NPN)

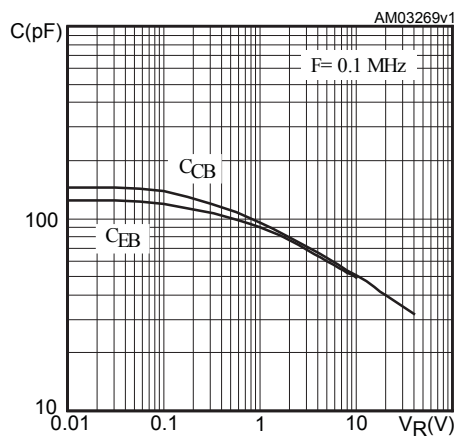
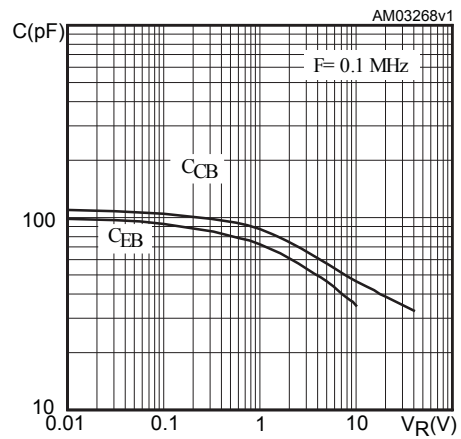
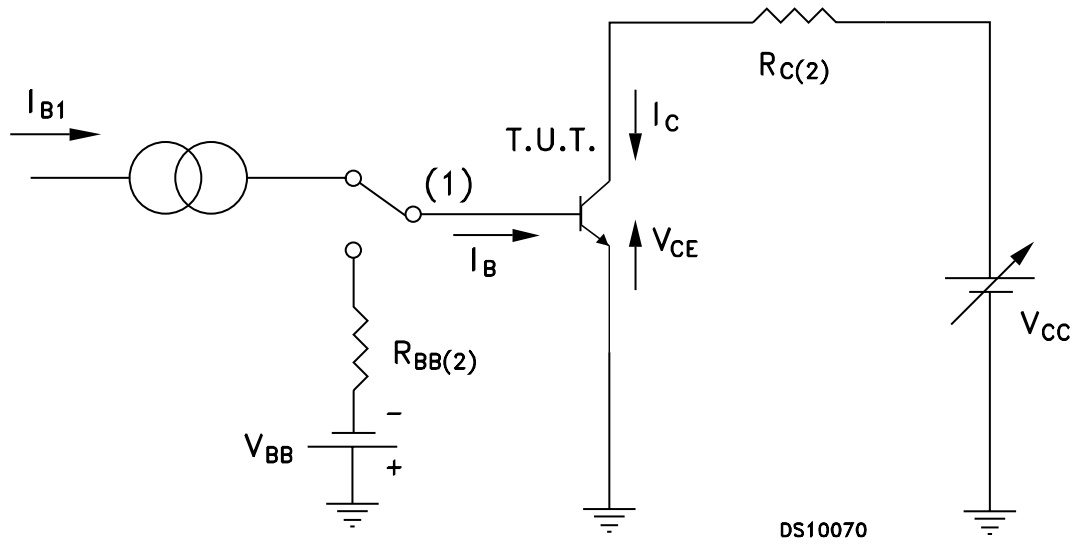

Figure 16. Capacitance characteristics (PNP)



3 Test circuits

Figure 17. Resistive load switching for NPN type



Note: (1) Fast electronic switch.

Note: (2) Non-inductive resistor.

Figure 18. Resistive load switching for PNP type

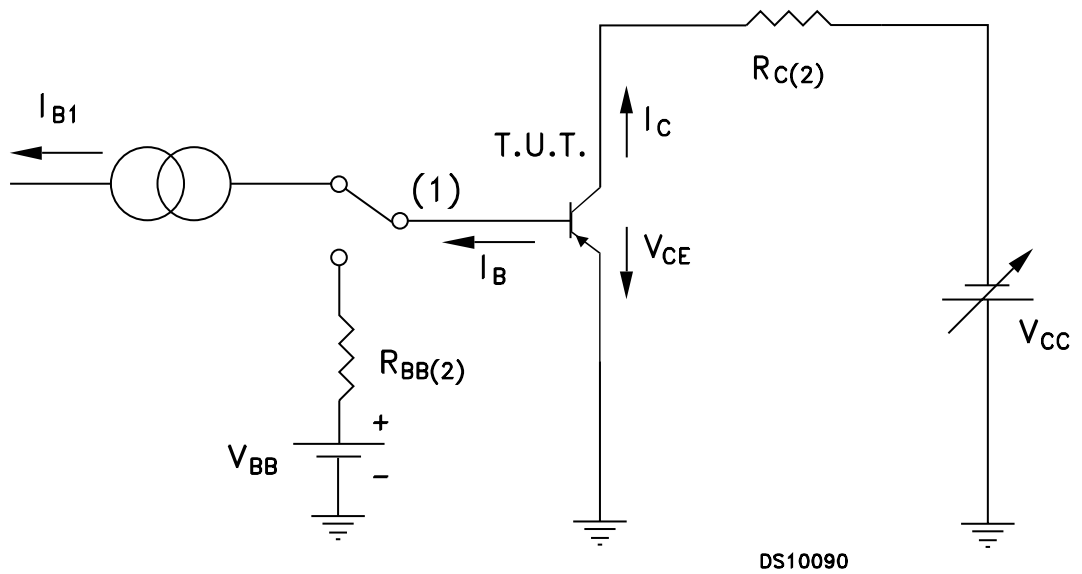

Note: (1) Fast electronic switch.

Note: (2) Non-inductive resistor.

4 Package information

In order to meet environmental requirements, ST offers these devices in different grades of **ECOPACK** packages, depending on their level of environmental compliance. ECOPACK specifications, grade definitions and product status are available at: www.st.com. ECOPACK is an ST trademark.

4.1 TO-220 type H package information

Figure 19. TO-220 type H package outline

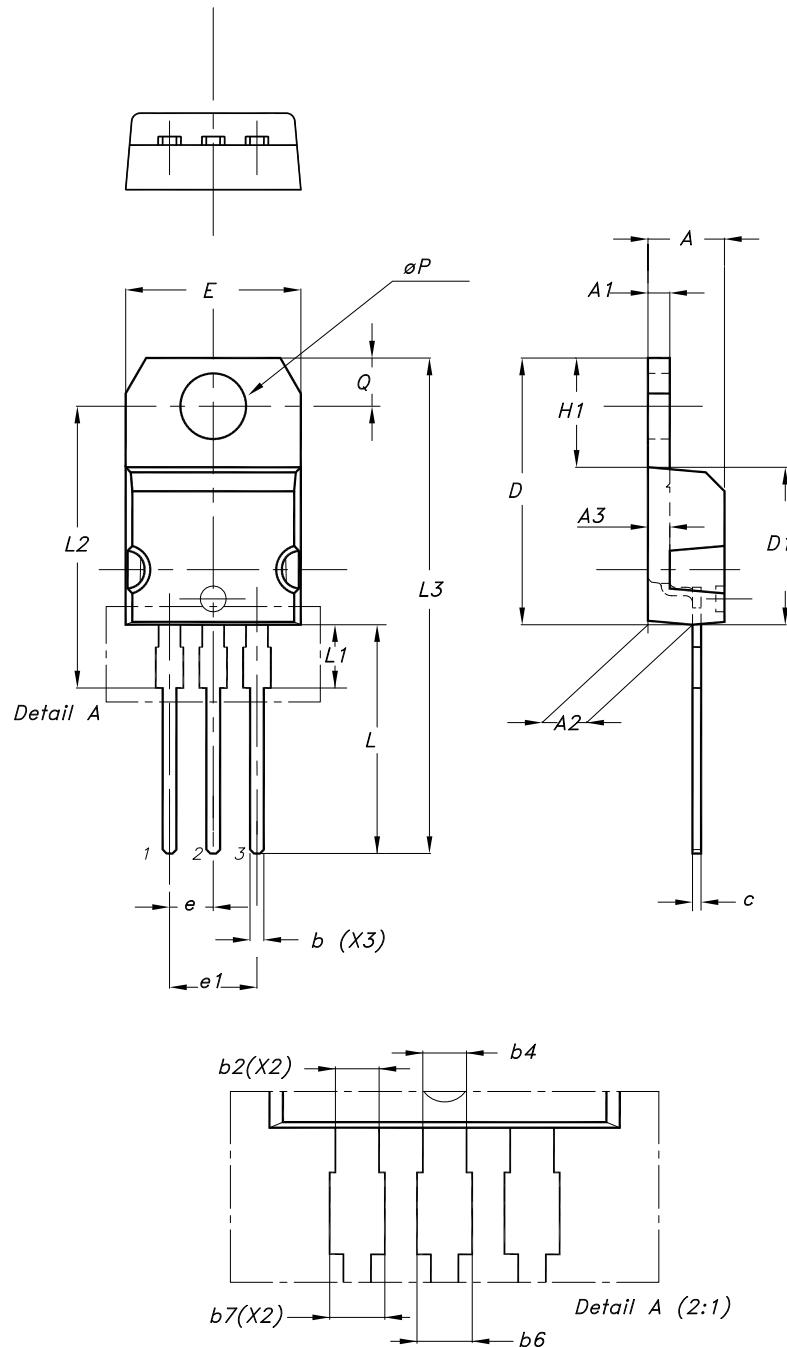

Table 4. TO-220 type H package mechanical data

Dim.	mm		
	Min.	Typ.	Max.
A	4.40	4.45	4.50
A1	1.22		1.32
A2	2.49	2.59	2.69
A3	1.17	1.27	1.37
b	0.78		0.87
b2	1.25		1.34
b4	1.20		1.29
b6			1.50
b7			1.45
c	0.49		0.56
D	15.40	15.50	15.60
D1	9.05	9.15	9.25
E	10.08	10.18	10.28
e	2.44	2.54	2.64
e1	4.98	5.08	5.18
H1	6.25	6.35	6.45
L	13.20	13.40	13.60
L1	3.50	3.70	3.90
L2	16.30	16.40	16.50
L3	28.70	28.90	29.10
∅P	3.75	3.80	3.85
Q	2.70	2.80	2.90
Slug flatness		0.03	0.10

5 Ordering information

Table 5. Order codes

Order codes	Marking	Polarity	Package	Packing
TIP120	TIP120	NPN	TO-220	Tube
TIP121	TIP121			
TIP122	TIP122			
TIP125	TIP125	PNP		
TIP127	TIP127			

Revision history

Table 6. Document revision history

Date	Version	Changes
21-Jun-2004	3	Document migration, no content change.
25-Nov-2008	4	Inserted new <i>Section 2.1: Electrical characteristics (curves)</i> .
11-May-2021	5	The part number TIP126 have been removed and the document has been updated accordingly. Updated title and added STPOWER LOGO in cover page. Updated <i>Section 4 Package information</i> . Minor text changes.

Contents

1	Electrical ratings	2
2	Electrical characteristics	3
2.1	Electrical characteristics (curves)	4
3	Test circuits	7
4	Package information	8
4.1	TO-220 type H package information	8
5	Ordering information	10
	Revision history	11

IMPORTANT NOTICE – PLEASE READ CAREFULLY

STMicroelectronics NV and its subsidiaries (“ST”) reserve the right to make changes, corrections, enhancements, modifications, and improvements to ST products and/or to this document at any time without notice. Purchasers should obtain the latest relevant information on ST products before placing orders. ST products are sold pursuant to ST’s terms and conditions of sale in place at the time of order acknowledgement.

Purchasers are solely responsible for the choice, selection, and use of ST products and ST assumes no liability for application assistance or the design of Purchasers’ products.

No license, express or implied, to any intellectual property right is granted by ST herein.

Resale of ST products with provisions different from the information set forth herein shall void any warranty granted by ST for such product.

ST and the ST logo are trademarks of ST. For additional information about ST trademarks, please refer to www.st.com/trademarks. All other product or service names are the property of their respective owners.

Information in this document supersedes and replaces information previously supplied in any prior versions of this document.

© 2021 STMicroelectronics – All rights reserved