



Serially Controlled, Clickless Audio/Video Switches

MAX4562/MAX4563

General Description

The MAX4562/MAX4563 serial-interface controlled switches are ideal for multimedia applications. Each device features 30Ω max on-resistance (RON), 5Ω RON match, and 5Ω RON flatness. Audio off-isolation and crosstalk at 20kHz is -85dB, and video off-isolation and crosstalk at 10MHz is -55dB. Both devices feature “clickless” mode operation for audio applications.

The MAX4562/MAX4563 contain two normally open single-pole/double-throw (SPDT) switches and two normally open single-pole/single-throw (SPST) switches. The MAX4562 features a 2-wire I²C™-compatible serial interface. The MAX4563 features a 3-wire SPI™/QSPI™/MICROWIRE™-compatible serial interface. Both parts are available in 16-pin QSOP packages and operate over the commercial and extended temperature ranges.

Applications

- Set-Top Boxes
- PC Multimedia Boards
- Audio Systems
- Video Conferencing Systems

Pin Configuration

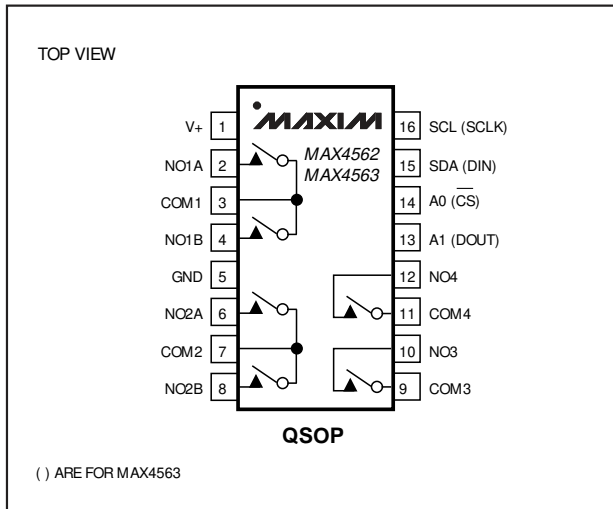

I²C is a trademark of Philips Corp.
 SPI/QSPI are trademarks of Motorola, Inc.
 MICROWIRE is a trademark of National Semiconductor Corp.

Features

- ◆ Selectable Soft-Switching Mode for “Clickless” Audio Operation
- ◆ 30Ω max On-Resistance
- ◆ Audio Performance
 - 85dB Off-Isolation at 20kHz
 - 85dB Crosstalk at 20kHz
 - 0.007% THD
- ◆ Video Performance
 - 55dB Off-Isolation at 10MHz
 - 55dB Crosstalk at 10MHz
- ◆ T-Switch Configurable for Improved Off-Isolation
- ◆ Serial Interface
 - 2-Wire I²C-Compatible (MAX4562)
 - 3-Wire SPI/QSPI/MICROWIRE-Compatible (MAX4563)
- ◆ Single-Supply Operation from +2.7V to +5.5V

Ordering Information

PART	TEMP. RANGE	PIN-PACKAGE
MAX4562CEE	0°C to +70°C	16 QSOP
MAX4562EEE	-40°C to +85°C	16 QSOP
MAX4563CEE	0°C to +70°C	16 QSOP
MAX4563EEE	-40°C to +85°C	16 QSOP

Typical Operating Circuit

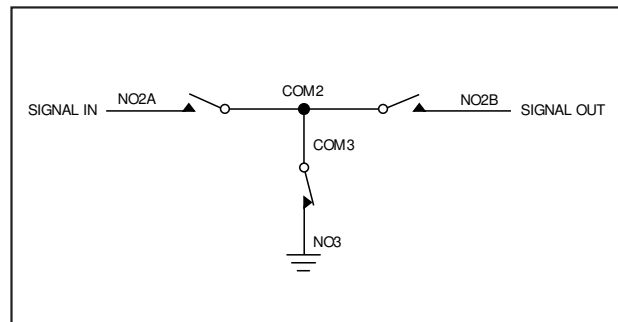

Serially Controlled, Clickless Audio/Video Switches

ABSOLUTE MAXIMUM RATINGS

V+ to GND	-0.3V to +6V
NO_, COM_, DOUT to GND (Note 1)	-0.3V to (V+ + 0.3V)
SCL, SDA, CS, SCLK, DIN, A0, A1 to GND	-0.3V to +6V
Continuous Current into Any Terminal	±20mA
Peak Current (NO_, COM_ pulsed at 1ms, 10% duty cycle max)	±50mA
Continuous Power Dissipation (T _A = +70°C) 16-Pin QSOP (derate 8.3mW/°C above +70°C)	667mW

Operating Temperature Ranges

MAX456_CEE	0°C to +70°C
MAX456_EEE	-40°C to +85°C
Storage Temperature Range	-65°C to +150°C
Lead Temperature (soldering, 10sec)	+300°C

Note 1: Signals on NO_ or COM_ exceeding V+ or ground are clamped by internal diodes. Limit forward-diode current to maximum current rating.

Stresses beyond those listed under "Absolute Maximum Ratings" may cause permanent damage to the device. These are stress ratings only, and functional operation of the device at these or any other conditions beyond those indicated in the operational sections of the specifications is not implied. Exposure to absolute maximum rating conditions for extended periods may affect device reliability.

ELECTRICAL CHARACTERISTICS—Single +5V Supply

(V+ = +5V ±5%, T_A = T_{MIN} to T_{MAX}, unless otherwise noted. Typical values are at T_A = +25°C.) (Note 2)

PARAMETER	SYMBOL	CONDITIONS	MIN	TYP	MAX	UNITS	
ANALOG SWITCHES							
Analog Signal Range (Note 3)	V _{NO_} , V _{COM_}		0		V+	V	
On-Resistance	R _{ON}	I _{COM_} = 4mA, V _{NO_} = 3V, V+ = 4.75V	T _A = +25°C	20	30	Ω	
			T _A = T _{MIN} to T _{MAX}		40		
On-Resistance Match Between Channels (Note 4)	ΔR _{ON}	I _{COM_} = 4mA, V _{NO_} = 3V, V+ = 4.75V	T _A = +25°C	3	5	Ω	
			T _A = T _{MIN} to T _{MAX}		7		
On-Resistance Flatness (Note 5)	R _{FLAT}	I _{COM_} = 4mA; V _{NO_} = 1V, 2V, 3V; V+ = 4.75V	T _A = +25°C	2	5	Ω	
			T _A = T _{MIN} to T _{MAX}		7		
NO_ Off-Leakage Current (Note 6)	I _{NO_(OFF)}	V _{NO_} = 4.5V, 1V; V _{COM_} = 1V, 4.5V; V+ = 5.25V	T _A = +25°C	-1	0.001	1	nA
			T _A = T _{MIN} to T _{MAX}	-10		10	
COM_ Off-Leakage Current (Note 6)	I _{COM_(OFF)}	V _{COM_} = 1V, 4.5V; V _{NO_} = 4.5V, 1V; V+ = 5.25V	T _A = +25°C	-1	0.001	1	nA
			T _A = T _{MIN} to T _{MAX}	-10		10	
COM_ On-Leakage Current (Note 6)	I _{COM_(ON)}	V _{COM_} = 4.5V, 1V; V _{NO_} = 4.5V, 1V, or floating; V+ = 5.25V	T _A = +25°C	-1	0.002	1	nA
			T _A = T _{MIN} to T _{MAX}	-10		10	
AUDIO PERFORMANCE							
Total Harmonic Distortion plus Noise	THD+N	f _{IN} = 1kHz, V _{NO_} = 1VRMS, V _{NO_} = 2.5V	R _L = 600Ω	0.07		%	
			R _L = 10kΩ	0.006			
Off-Isolation (Note 7)	V _{ISO(A)}	V _{NO_} = 1VRMS, f _{IN} = 20kHz, R _L = 600Ω, Figure 1		-85		dB	
Channel-to-Channel Crosstalk	V _{CT(A)}	V _{NO_} = 1VRMS, f _{IN} = 20kHz, R _S = 600Ω, Figure 1		-85		dB	

Serially Controlled, Clickless Audio/Video Switches

MAX4562/MAX4563

ELECTRICAL CHARACTERISTICS—Single +5V Supply (continued)

(V₊ = +5V ±5%, T_A = T_{MIN} to T_{MAX}, unless otherwise noted. Typical values are at T_A = +25°C.) (Note 2)

PARAMETER	SYMBOL	CONDITIONS	MIN	TYP	MAX	UNITS
VIDEO PERFORMANCE						
Off-Isolation (Note 7)	V _{ISO(V)}	V _{NO__} = 1V _{RMS} , f _{IN} = 10MHz, R _L = 50Ω, Figure 1		-55		dB
Channel-to-Channel Crosstalk	V _{CT(V)}	V _{NO__} = 1V _{RMS} , f _{IN} = 10MHz, R _S = 50Ω, Figure 1		-55		dB
-3dB Bandwidth	BW	R _{SOURCE} = 50Ω, R _L = 50Ω		300		MHz
Off-Capacitance	C _{OFF(NO)}	f _{IN} = 1MHz		10		pF
DYNAMIC TIMING WITH CLICKLESS MODE DISABLED (Note 8, Figure 2)						
Turn-On Time	t _{ONSD}	V _{NO__} = 2.5V, R _L = 5kΩ, C _L = 35pF	T _A = +25°C	200	400	ns
			T _A = T _{MIN} to T _{MAX}		500	
Turn-Off Time	t _{OFFSD}	V _{NO__} = 2.5V, R _L = 300Ω, C _L = 35pF	T _A = +25°C	100	160	ns
			T _A = T _{MIN} to T _{MAX}		200	
Break-Before-Make Time	t _{BBM}	V _{NO__} = 2.5V, T _A = T _{MIN} to T _{MAX}	10	50		ns
DYNAMIC TIMING WITH CLICKLESS MODE ENABLED (Note 8, Figure 2)						
Turn-On Time	t _{ONSE}	V _{NO__} = 2.5V, R _L = 5kΩ, C _L = 35pF		12		ms
Turn-Off Time	t _{OFFSE}	V _{NO__} = 2.5V, R _L = 300Ω, C _L = 35pF		3		ms
POWER SUPPLY						
Supply Voltage Range	V ₊	T _A = T _{MIN} to T _{MAX}	2.7		5.5	V
Supply Current (Note 9)	I ₊	All logic inputs = 0 or V ₊ , T _A = T _{MIN} to T _{MAX}		6	10	μA

ELECTRICAL CHARACTERISTICS—Single +3V Supply

(V₊ = +3V ±10%, T_A = T_{MIN} to T_{MAX}, unless otherwise noted. Typical values are at T_A = +25°C.) (Note 2)

PARAMETER	SYMBOL	CONDITIONS	MIN	TYP	MAX	UNITS
ANALOG SWITCHES						
Analog Signal Range (Note 3)	V _{NO__} , V _{COM__}		0		V ₊	V
On-Resistance	R _{ON}	I _{COM__} = 4mA, V _{NO__} = 1V, V ₊ = 2.7V	T _A = +25°C	30	60	Ω
			T _A = T _{MIN} to T _{MAX}		80	
On-Resistance Match Between Channels (Note 4)	ΔR _{ON}	I _{COM__} = 4mA, V _{NO__} = 1V, V ₊ = 2.7V	T _A = +25°C	3	5	Ω
			T _A = T _{MIN} to T _{MAX}		7	

Serially Controlled, Clickless Audio/Video Switches

ELECTRICAL CHARACTERISTICS—Single +3V Supply (continued)

(V+ = +3V ±10%, T_A = T_{MIN} to T_{MAX}, unless otherwise noted. Typical values are at T_A = +25°C.) (Note 2)

PARAMETER	SYMBOL	CONDITIONS		MIN	TYP	MAX	UNITS
On-Resistance Flatness (Note 5)	R _{FLAT}	I _{COM_} = 4mA; V _{NO_} = 1V, 1.5V, 2V; V+ = 2.7V	T _A = +25°C		3	6	Ω
			T _A = T _{MIN} to T _{MAX}			8	
NO_ Off-Leakage Current (Notes 6, 10)	I _{NO_(OFF)}	V _{COM_} = 0.5V, 3V; V _{NO_} = 3V, 0.5V; V+ = 3.6V	T _A = +25°C	-1	0.001	1	nA
			T _A = T _{MIN} to T _{MAX}	-10		10	
COM_ Off-Leakage Current (Notes 6, 10)	I _{COM_(OFF)}	V _{COM_} = 0.5V, 3V; V _{NO_} = 3V, 0.5V; V+ = 3.6V	T _A = +25°C	-1	0.001	1	nA
			T _A = T _{MIN} to T _{MAX}	-10		10	
COM_ On-Leakage Current (Notes 6, 10)	I _{COM_(ON)}	V _{COM_} = 3V, 0.5V; V _{NO_} = 3V, 0.5V, or floating; V+ = 3.6V	T _A = +25°C	-1	0.002	1	nA
			T _A = T _{MIN} to T _{MAX}	-10		10	
AUDIO PERFORMANCE							
Total Harmonic Distortion plus Noise	THD+N	f _{IN} = 1kHz, V _{NO_} = 0.5V _{RMS} , V _{NO_} = 1.5V	R _L = 600Ω		0.1		%
			R _L = 10kΩ		0.01		
Off-Isolation (Note 7)	V _{ISO(A)}	V _{NO_} = 0.5V _{RMS} , f _{IN} = 20kHz, R _L = 600Ω, Figure 1			80		dB
Channel-to-Channel Crosstalk	V _{CT(A)}	V _{NO_} = 0.5V _{RMS} , f _{IN} = 20kHz, R _S = 600Ω, Figure 1			85		dB
VIDEO PERFORMANCE							
Off-Isolation (Note 7)	V _{ISO(V)}	V _{NO_} = 0.5V _{RMS} , f _{IN} = 10MHz, R _L = 50Ω, Figure 1			-50		dB
Channel-to-Channel Crosstalk	V _{CT(V)}	V _{NO_} = 0.5V _{RMS} , f _{IN} = 10MHz, R _S = 50Ω, Figure 1			-55		dB
-3dB Bandwidth	BW	R _{SOURCE} = 50Ω, R _L = 50Ω			200		MHz
Off-Capacitance	C _{OFF(NO)}	f _{IN} = 1MHz			10		pF
DYNAMIC TIMING WITH CLICKLESS MODE DISABLED (Notes 8, 12, and Figure 2)							
Turn-On Time	t _{ONSD}	V _{NO_} = 1.5V, R _L = 5kΩ, C _L = 35pF	T _A = +25°C		400	800	ns
			T _A = T _{MIN} to T _{MAX}			1000	
Turn-Off Time	t _{OFFSD}	V _{NO_} = 1.5V, R _L = 300Ω, C _L = 35pF	T _A = +25°C		200	350	ns
			T _A = T _{MIN} to T _{MAX}			500	
Break-Before-Make Time	t _{BBM}	V _{NO_} = 1.5V, T _A = T _{MIN} to T _{MAX}		10	100		ns
DYNAMIC TIMING WITH CLICKLESS MODE ENABLED (Notes 8, 12, and Figure 2)							
Turn-On Time	t _{ONSE}	V _{NO_} = 1.5V, R _L = 5kΩ, C _L = 35pF			12		ms
Turn-Off Time	t _{OFFSE}	V _{NO_} = 1.5V, R _L = 300Ω, C _L = 35pF			3		ms

Serially Controlled, Clickless Audio/Video Switches

MAX4562/MAX4563

I/O INTERFACE CHARACTERISTICS

(V+ = +2.7V to +5.25V, T_A = T_{MIN} to T_{MAX}, unless otherwise noted. Typical values are at T_A = +25°C.)

PARAMETER	SYMBOL	CONDITIONS	MIN	TYP	MAX	UNITS
DIGITAL INPUTS (SCLK, DIN, \overline{CS}, SCL, SDA, A0, A1)						
Input Low Voltage	V _{IL}	V+ = 5V			0.8	V
		V+ = 3V			0.6	
Input High Voltage	V _{IH}	V+ = 5V	3			V
		V+ = 3V	2			
Input Hysteresis	V _{HYST}			0.2		V
Input Leakage Current	I _{LEAK}	Digital inputs = 0 or V+	-1	0.001	1	μA
Input Capacitance	C _{IN}	f = 1MHz		5		pF
DIGITAL OUTPUTS (DOUT, SDA)						
Output Low Voltage	V _{OL}	I _{SINK} = 6mA			0.4	V
DOUT Output High Voltage	V _{OH}	I _{SOURCE} = 0.5mA	V+ - 0.5			V

2-WIRE TIMING CHARACTERISTICS

(Figure 3, V+ = +2.7V to +5.25V, f_{SCL} = 100kHz, T_A = T_{MIN} to T_{MAX}, unless otherwise noted. Typical values are at T_A = +25°C.)

PARAMETER	SYMBOL	CONDITIONS	MIN	TYP	MAX	UNITS
SCL Clock Frequency	f _{SCL}	V+ = 2.7V to 5.25V	0		100	kHz
		V+ = 4.75V to 5.25V			400	
Bus Free Time between Stop and Start Conditions	t _{BUF}		4.7			μs
Hold Time After Start Condition	t _{HD:STA}	The first clock is generated after this period	4.0			μs
Stop Condition Setup Time	t _{SU:STO}		4.0			μs
Data Hold Time	t _{HD:DAT}		0			μs
Data Setup Time	t _{SU:DAT}		250			ns
Clock Low Period	t _{LOW}		4.7			μs
Clock High Period	t _{HIGH}		4.0			μs
SCL/SDA Rise Time	t _R		20 + 0.1C _b		300	ns
SCL/SDA Fall Time	t _F		20 + 0.1C _b		300	ns
Pulse Width of Suppressed Spike			0		50	ns

Serially Controlled, Clickless Audio/Video Switches

3-WIRE TIMING CHARACTERISTICS

(Figure 5, $V_+ = +2.7V$ to $+5.25V$, $f_{OP} = 2.1MHz$, $T_A = T_{MIN}$ to T_{MAX} , unless otherwise noted. Typical values are at $T_A = +25^\circ C$.)

PARAMETER	SYMBOL	CONDITIONS	MIN	TYP	MAX	UNITS
Operating Frequency	f_{OP}	$V_+ = 2.7V$ to $5.25V$	0		2.1	MHz
		$V_+ = 4.75V$ to $5.25V$			10	
DIN to SCLK Setup	t_{DS}		100			ns
DIN to SCLK Hold	t_{DH}		0			ns
\overline{CS} Fall to SCLK Rise Setup	t_{CSS}		100			ns
\overline{CS} Fall to SCLK Rise Hold	t_{CSH}		0			ns
SCLK Pulse Width Low	t_{CL}		200			ns
SCLK Pulse Width High	t_{CH}		200			ns
Rise Time (SCLK, DIN, \overline{CS})	t_R				2	μs
Fall Time (SCLK, DIN, \overline{CS})	t_F				2	μs
SCLK Fall to Output Data Valid	t_{DO}	$C_{LOAD} = 50pF$			200	ns
\overline{CS} Pulse Width High	t_{CSW}			40		ns

- Note 2:** The algebraic convention is used in this data sheet; the most negative value is shown in the minimum column.
- Note 3:** Guaranteed by design. Not subject to production testing.
- Note 4:** $\Delta R_{ON} = R_{ON(MAX)} - R_{ON(MIN)}$.
- Note 5:** Resistance flatness is defined as the difference between the maximum and minimum on-resistance values, as measured over the specified analog signal range.
- Note 6:** Leakage parameters are 100% tested at maximum rated temperature and guaranteed by correlation at $T_A = +25^\circ C$.
- Note 7:** Off-isolation = $20 \log (V_{COM_} / V_{NO_})$, $V_{COM_}$ = output, $V_{NO_}$ = input to off switch.
- Note 8:** All timing is measured from the clock's falling edge preceding the ACK signal for 2-wire and from the rising edge of \overline{CS} for 3-wire. Turn-off time is defined at the output of the switch for a 0.5V change, tested with a 300 Ω load to ground. Turn-on time is defined at the output of the switch for a 0.5V change and measured with a 5k Ω load resistor to GND. All timing is shown with respect to 20% V_+ and 70% V_+ , unless otherwise noted.
- Note 9:** Supply current can be as high as 2mA per switch during switch transitions in the clickless mode, corresponding to a 12mA total supply transient current requirement.
- Note 10:** Leakage testing is guaranteed by testing with a +5.25V supply.
- Note 11:** C_b = capacitance of one bus line in pF. Tested with $C_b = 400pF$.
- Note 12:** Typical values are for MAX4563 devices.

Typical Operating Characteristics

($V_+ = +5V$, $T_A = +25^\circ C$, unless otherwise noted.)

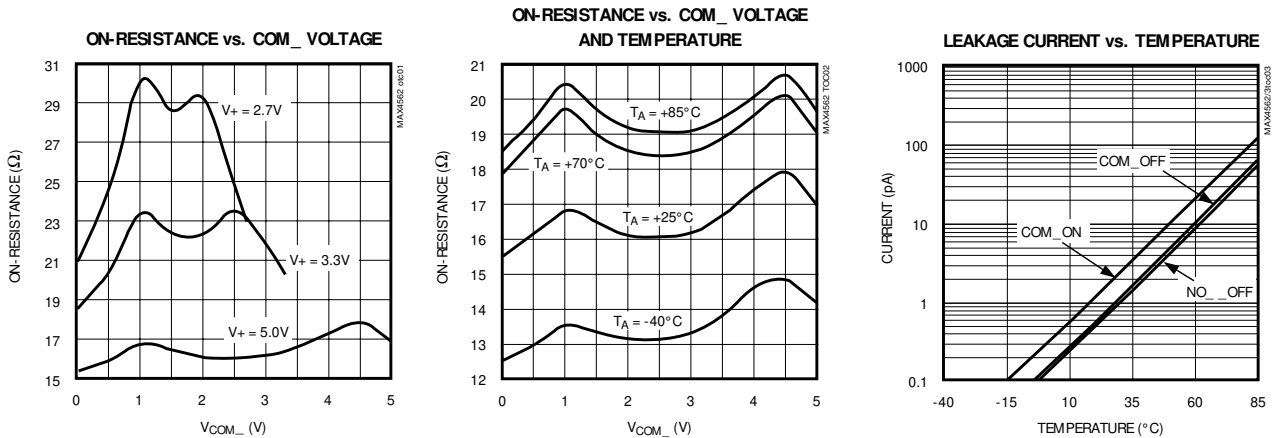

Serially Controlled, Clickless Audio/Video Switches

Typical Operating Characteristics (continued)

($V_+ = +5V$, $T_A = +25^\circ C$, unless otherwise noted.)

MAX4562/MAX4563

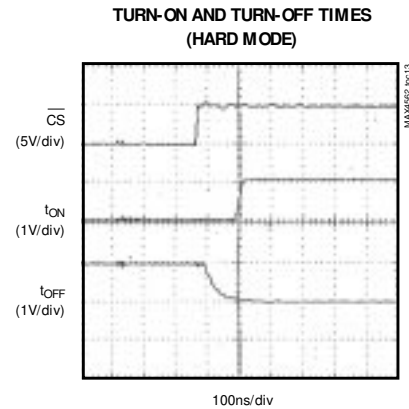
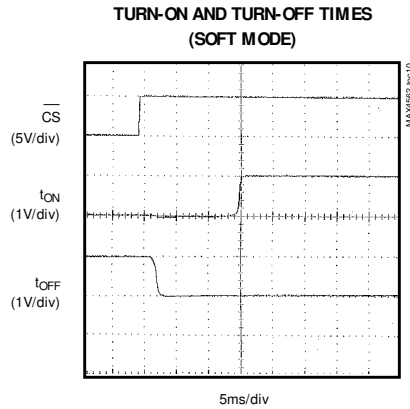
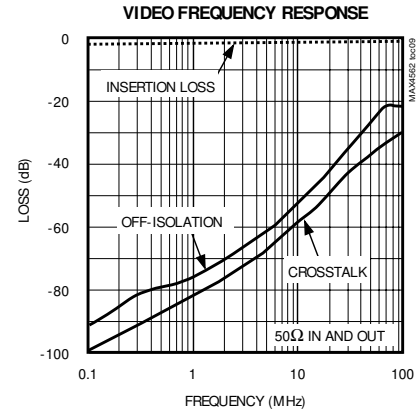
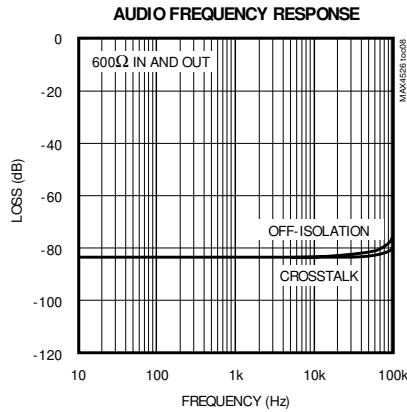
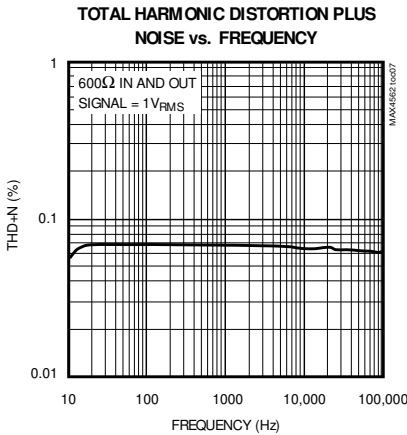
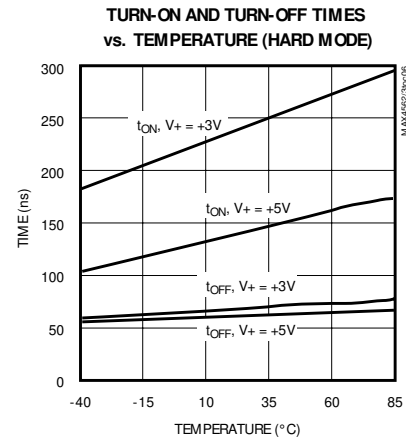
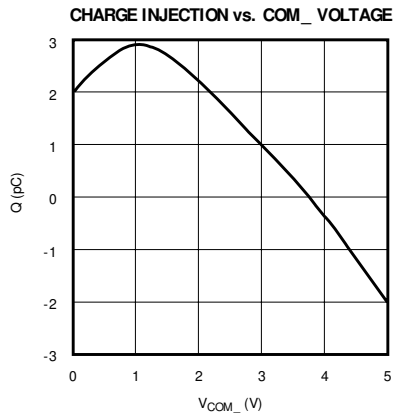
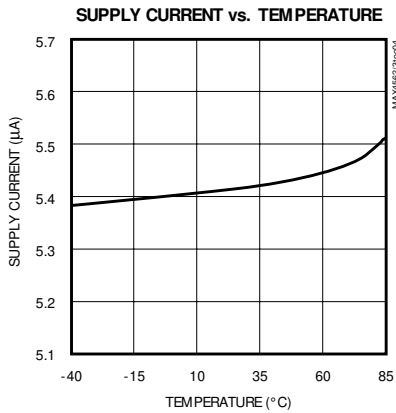

Serially Controlled, Clickless Audio/Video Switches

Typical Operating Characteristics (continued)

(V+ = +5V, T_A = +25°C, unless otherwise noted.)

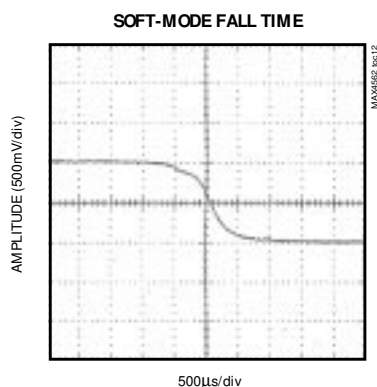
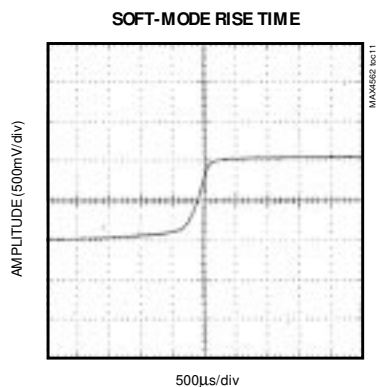

Pin Description

PIN		NAME	FUNCTION
MAX4562	MAX4563		
1	1	V+	Positive Supply Voltage
2, 4, 6, 8, 10, 12	2, 4, 6, 8, 10, 12	NO1A, NO1B, NO2A, NO2B, NO3, NO4	Normally Open Terminals
3, 7, 9, 11	3, 7, 9, 11	COM1–COM4	Common Terminals
5	5	GND	Ground
13	–	A1	LSB + 2 of 2-Wire Serial Interface Address Field
–	13	DOUT	Data Input of 3-Wire Serial Interface
14	–	A0	LSB + 1 of 2-Wire Serial Interface Address Field
–	14	$\overline{\text{CS}}$	Chip-Select of 3-Wire Serial Interface
15	–	SDA	Data Input of 2-Wire Serial Interface
–	15	DIN	Data Input of 3-Wire Serial Interface
16	–	SCL	Clock Input of 2-Wire Serial Interface
–	16	SCLK	Clock Input of 3-Wire Serial Interface

Serially Controlled, Clickless Audio/Video Switches

MAX4562/MAX4563

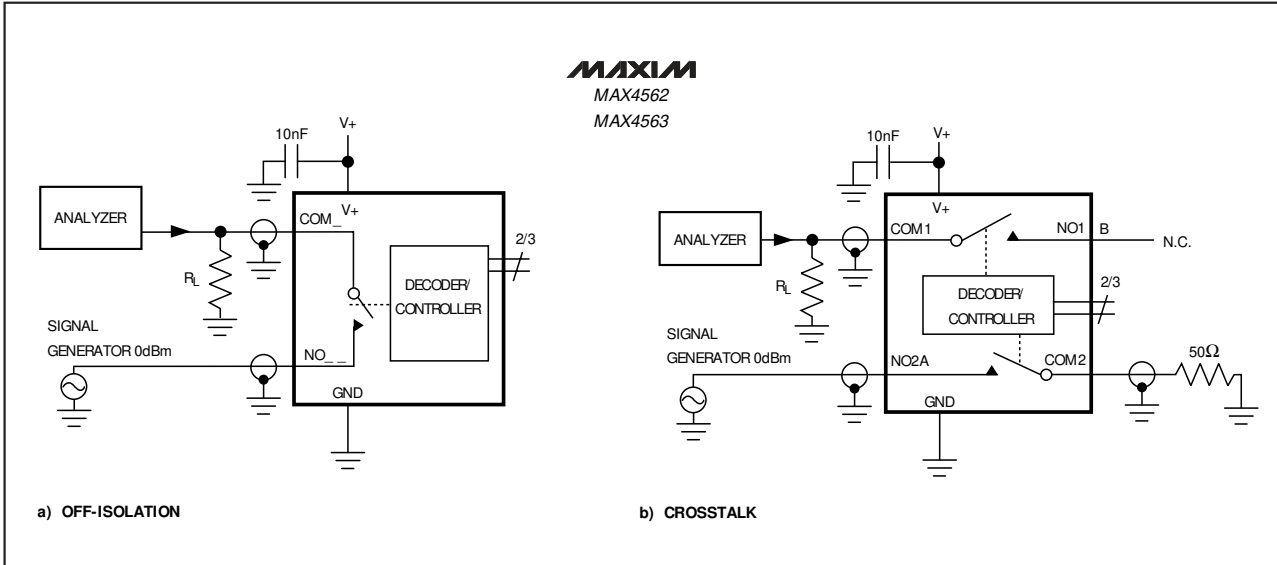

Figure 1. Off-Isolation and Crosstalk

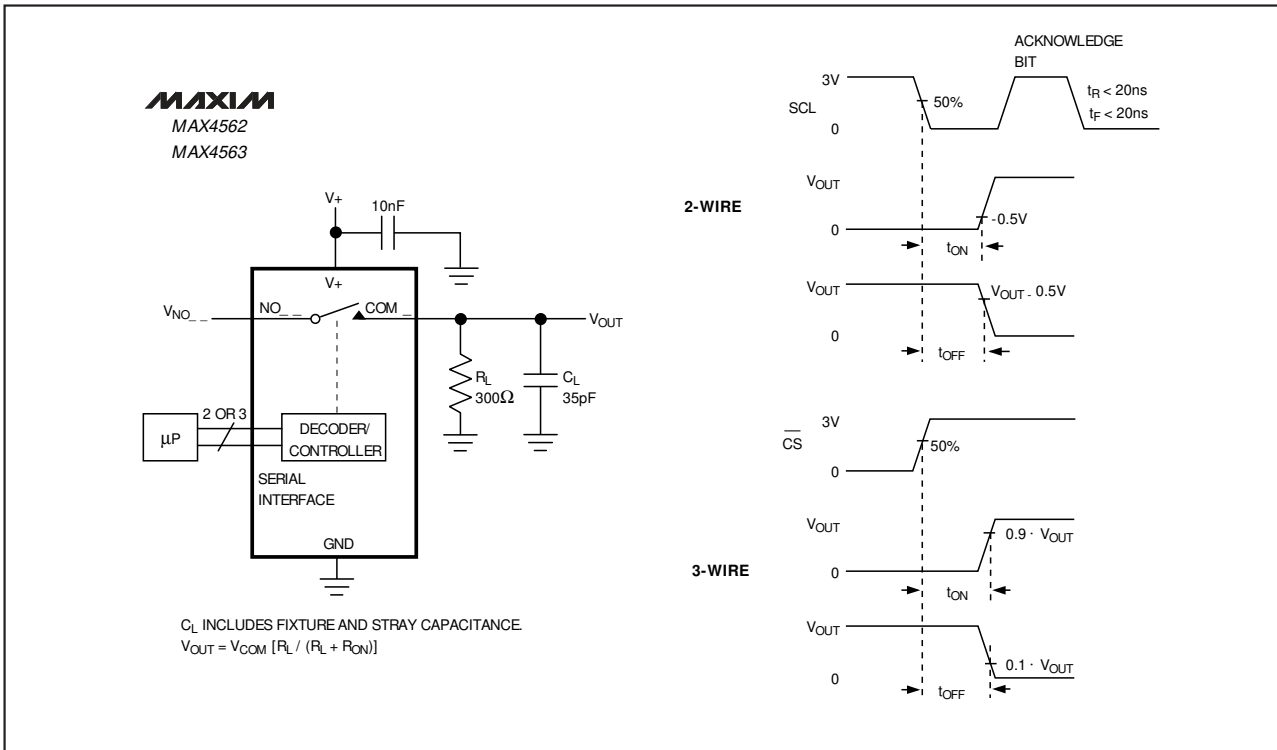

Figure 2. Switching Time

Serially Controlled, Clickless Audio/Video Switches

Detailed Description

The MAX4562/MAX4563 are serial-interface controlled switches with soft-mode “clickless” and hard-mode operating capability. The MAX4562/MAX4563 contain two SPST switches and two SPDT switches. The SPDT switches are actually 2-to-1 multiplexers, in that each SPDT is really two independent SPST switches with a common node, as shown in the *Pin Configuration*. Each switch is controlled independently by either the 2-wire I²C-compatible or 3-wire SPI/QSPI/MICROWIRE-compatible serial interface.

Audio off-isolation and crosstalk is -85dB at 20kHz. Video off-isolation and crosstalk is at least -55dB at 10MHz.

Each switch of either device may be set to operate in either soft or hard mode. In soft mode, the switching

transition is slowed to avoid the audible “clicking” that can occur when switches are used to route audio signals. In hard mode, the switches are not slowed down, making this mode useful when a faster response is required. If a new command is issued while any soft-mode switch is transitioning, the switch transition time is decreased so it reaches its final state before the new command is executed. Soft mode and open are the power-up default states for all switches. Switches in the same mode are guaranteed to be break-before-make relative to each other. Break-before-make does not apply between switches operating in different modes.

These devices operate from a +2.7V to +5.5V single supply. The MAX4562 features a 2-wire I²C-compatible serial interface, and the MAX4563 features a 3-wire SPI/QSPI/MICROWIRE-compatible serial interface.

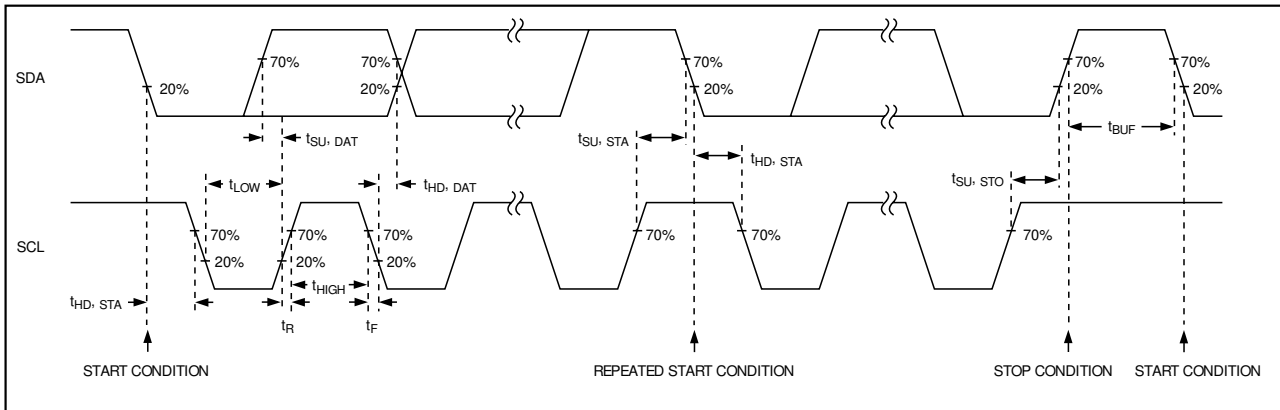

Figure 3. 2-Wire Serial-Interface Timing Diagram

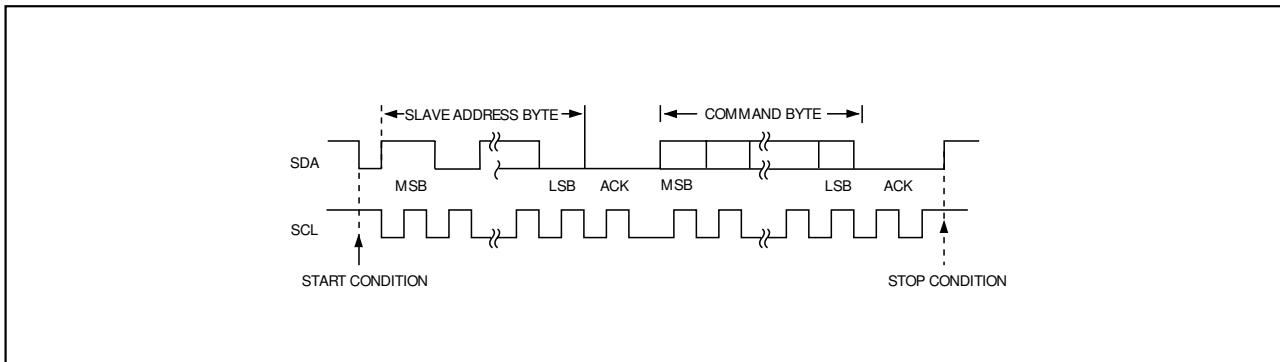

Figure 4. A Complete 2-Wire Serial-Interface Transmission

Serially Controlled, Clickless Audio/Video Switches

MAX4562/MAX4563

Table 1. Command-Bit Mapping

C1	C0	COMMAND	DESCRIPTION
0	0	NO_OP	No Operation
0	1	NO_OP	No Operation
1	0	SWITCHSET	Sets specified switches open or closed.
1	1	MODESET	Sets specified switches to soft or hard mode.

Table 2. Control-Bit Mapping

CONTROL BIT	SWITCH	SWITCH TERMINAL
D5	SW1A	2, 3
D4	SW1B	3, 4
D3	SW2A	6, 7
D2	SW2B	7, 8
D1	SW3	9, 10
D0 (LSB)	SW4	11, 12

Applications Information

Switch Control

The MAX4562/MAX4563 have a common command-and control-bit structure; the only difference is the interface type (2-wire or 3-wire).

The SWITCHSET command controls the open/closed states of the various switches. MODESET controls soft/hard-mode switch states. The NO_OP command is useful for daisy-chaining multiple 3-wire parts.

Table 1 shows the command bits' configuration and their related commands. Table 2 shows the configuration of the data bits and their related switches. After a SWITCHSET command is issued, a logic "1" in any data-bit location closes the associated switch, while a logic "0" opens it. After a MODESET command, a logic "1" in any data-bit location sets the associated switch into soft mode, while a logic "0" sets it into hard mode.

2-Wire Serial Interface

The MAX4562 uses a 2-wire I²C-compatible serial interface, requiring only two I/O lines of a standard micro-processor port for communication. These devices use a SendByte™ protocol. The SendByte protocol consists of one byte of address field followed by one byte of command field.

The first byte of any 2-wire serial-interface transaction is always the address byte. To address a given chip, the

A0 and A1 bits in the address byte (Table 3) must duplicate the values present at the A0 and A1 pins of that chip, and the rest of the address bits must be configured as shown in Table 3. Connect the A0 and A1 pins to V+ or GND or drive them with CMOS logic levels.

The second byte is the command byte, which sets the command being written to the device. The possible commands are MODESET and SWITCHSET. Figures 3 and 4 and the *I/O Interface Characteristics* detail the timing of the 2-wire serial-interface protocol. All bytes of the transmission, whether address or command, are sent MSB first.

The MAX4562/MAX4563 are receive-only devices and must be controlled by a bus master device. A bus master signals the beginning of a transmission with a start condition by transitioning SDA from high to low while SCL is high. The slave devices monitor the serial bus continuously, waiting for the start condition followed by an address byte. When a device recognizes its address byte, it acknowledges by pulling the SDA line low for one clock period; it is then ready to accept the command byte. The device also issues a similar acknowledgment after the command byte. When the master has finished communicating with the slave, it issues a stop condition by transitioning SDA from low to high while SCL is high. The bus is then free for another transmission.

3-Wire Serial Interface

The MAX4563 uses a 3-wire SPI/QSPI/MICROWIRE-compatible serial interface. An active-low chip select (\overline{CS}) pin enables the device to receive data from the serial input pin, DIN. Command and data information are clocked in on the rising edge of the serial clock signal (SCLK) MSB first. A total of eight bits is needed in each write cycle. The command code is contained in the two MSBs of the 8-bit word. The remaining bits control the switches as shown in Table 4. While shifting in the serial data, the device remains in its original configuration. A rising edge on \overline{CS} latches the data into the MAX4563's internal register, initiating the device's change of state. Table 4 shows the details of the 3-wire interface structure.

SendByte is a trademark of Philips Corp.

Serially Controlled, Clickless Audio/Video Switches

Table 3. MAX4562 2-Wire Serial-Interface Data Format

	ADDRESS BYTE									COMMAND BYTE									
	MSB					LSB				MSB				LSB					
SRT	1	0	0	1	1	A1	A0	0	ACK	C1	C0	SW2A	SW1B	SW2A	SW2B	SW3	SW4	ACK	STP

STP = Stop Condition

Logic "0" in any data bit location places the associated switch open or in hard switching mode.

Logic "1" in any data bit location places the associated switch closed or in soft (clickless) switching mode.

See Table 1 for command-bit configuration.

Table 4. MAX4563 3-Wire Serial-Interface Data Format

COMMAND		SWITCH CONTROL					
MSB							LSB
D7	D6	D5	D4	D3	D2	D1	D0
C1	C0	SW1A	SW1B	SW2A	SW3B	SW3	SW4

Figures 5 and 6 and the *I/O Interface Characteristics* show the timing details of the 3-wire interface. If the two command bits initiate a SWITCHSET command, a logic "1" in a switch control location closes the associated switch, while a logic "0" opens it. If the command bits initiate a MODESET command, a logic "1" in a switch control location sets the associated switch into soft "clickless" mode, while a logic "0" sets it into hard mode. For command-bit configurations, see Table 1.

Using Multiple Devices

There are two ways to connect multiple devices to the same 3-wire serial interface. The first involves using the DOUT pin. DOUT presents a copy of the last bit of the internal shift register, useful for daisy-chaining multiple devices. Data at DOUT are simply the input data delayed by eight clock cycles, appearing synchronous with SCLK's falling edge. After \overline{CS} goes high, DOUT holds the last bit in the shift register until new data are shifted into DIN. For a simple interface using several MAX4563 devices, daisy-chain the shift registers by connecting DOUT of the first device to DIN of the second, etc. Connect the \overline{CS} pins of all devices together.

Data are shifted through the MAX4563 in series. When \overline{CS} is brought high, all devices are updated simultaneously. If any of the devices in the chain are to be left unchanged, use a NO_OP command for that device, as shown in Table 1.

An alternate way of connecting multiple devices is to decode the \overline{CS} line. In this case, do not use the DOUT pin and connect the DIN pins of all devices together. Address decode logic individually controls the \overline{CS} line of each device. When a device is to be selected, its \overline{CS} line is brought low, data are shifted in, and its \overline{CS} line is then brought high to execute the command.

For command bit configuration see Table 1.

T-Switches

Configure the MAX4562/MAX4563 as a T-switch to improve off-isolation. As the signal frequency is increased, parasitic capacitance significantly degrades the off-isolation. Figure 7 shows a typical T-switch configuration using the MAX4562/MAX4563 to improve off-isolation. COM2 and COM3 are tied together to create a single common node. NO2A and NO2B act as the input and output of the T-switch, while NO3 is tied to ground. When both SW2A and SW2B are closed, SW3 should be open to allow the signal to pass into NO2A and out of NO2B. However, when SW2A and SW2B are open, energy that is coupled through the open switches is shunted to ground through SW3, which should now be closed. This increases the off-isolation to typically -68dB at 10MHz (Figure 8).

Serially Controlled, Clickless Audio/Video Switches

MAX4562/MAX4563

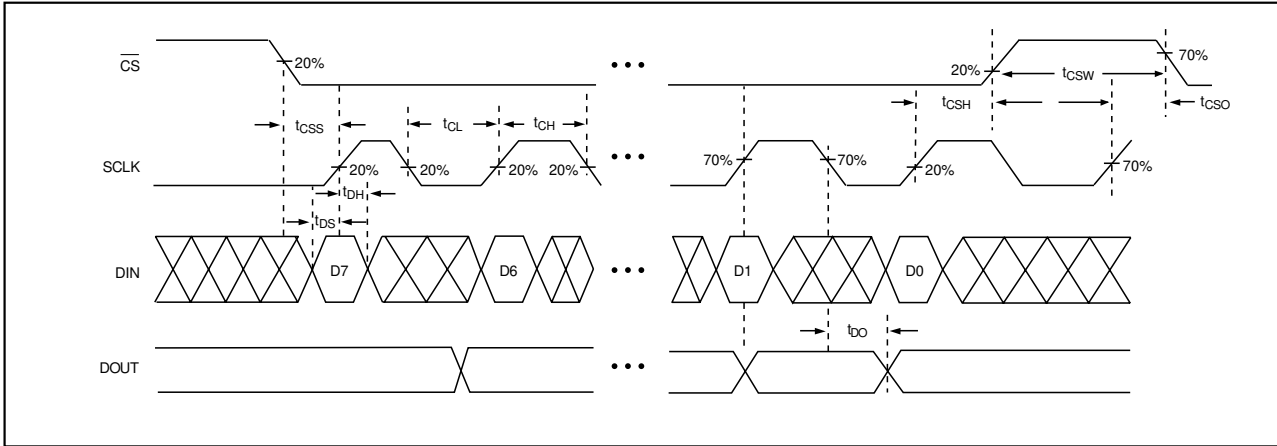

Figure 5. 3-Wire Serial-Interface Timing Diagram

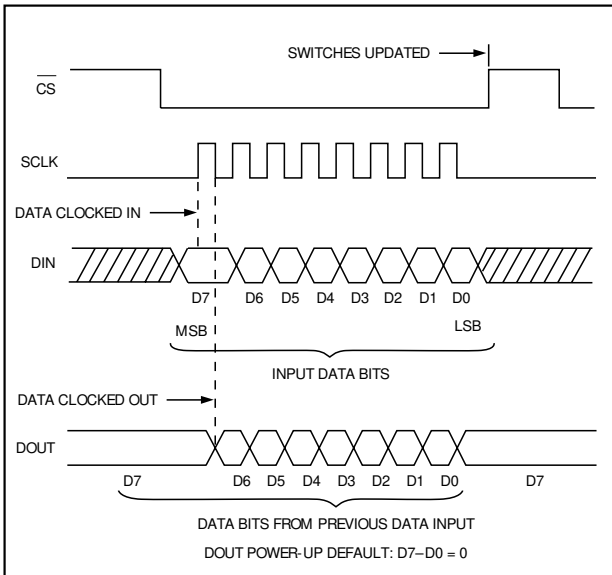

Figure 6. A Complete 3-Wire Serial-Interface Transmission

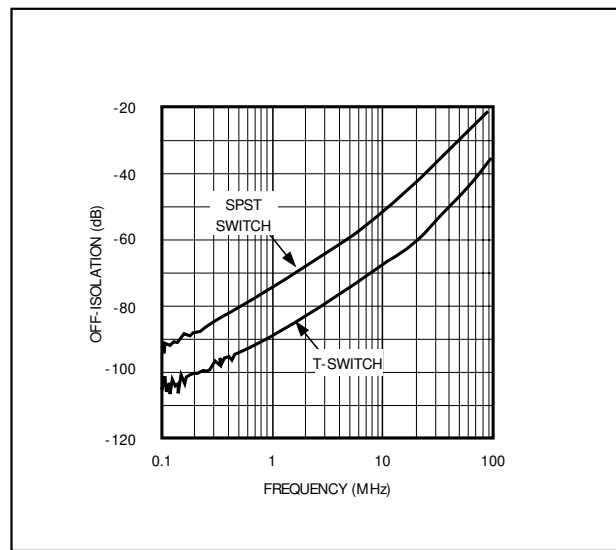

Figure 8. Off-Isolation vs. Frequency

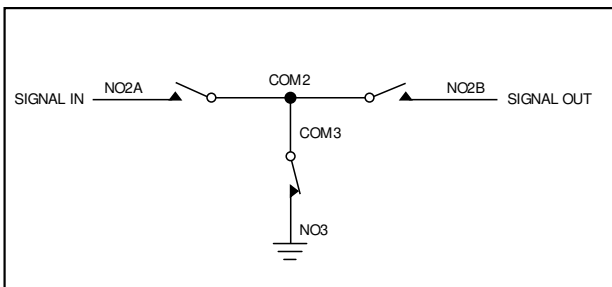

Figure 7. T-Switch Configuration

Chip Information

TRANSISTOR COUNT: 3518

Serially Controlled, Clickless Audio/Video Switches

Package Information

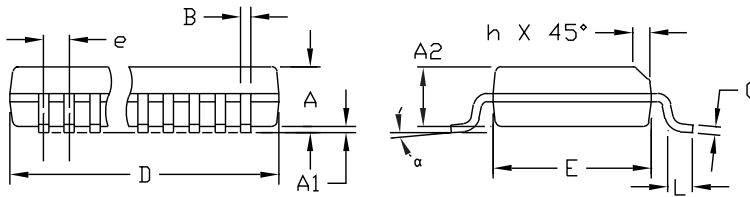
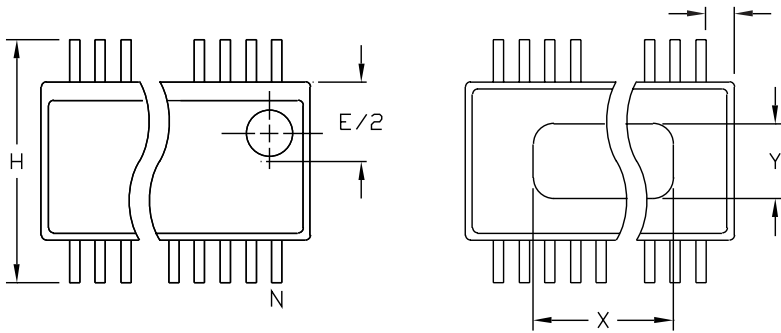

NOTES:

1. D & E DO NOT INCLUDE MOLD FLASH OR PROTRUSIONS
2. MOLD FLASH OR PROTRUSIONS NOT TO EXCEED .006" PER SIDE.
3. HEAT SLUG DIMENSIONS X AND Y APPLY ONLY TO 16 AND 28 LEAD POWER-QSOP PACKAGES.
4. CONTROLLING DIMENSIONS: INCHES.

DIM	INCHES		MILLIMETERS	
	MIN	MAX	MIN	MAX
A	.061	.068	1.55	1.73
A1	.004	.0098	0.102	0.249
A2	.055	.061	1.40	1.55
B	.008	.012	0.20	0.31
C	.0075	.0098	0.191	0.249
D	SEE VARIATIONS			
E	.150	.157	3.81	3.99
e	.025 BSC		0.635 BSC	
H	.230	.244	5.84	6.20
h	.010	.016	0.25	0.41
L	.016	.035	0.41	0.89
N	SEE VARIATIONS			
X	SEE VARIATIONS			
Y	.071	.087	1.803	2.209
α	0°	8°	0°	8°

VARIATIONS:

DIM	INCHES		MILLIMETERS		N
	MIN.	MAX.	MIN.	MAX.	
D	.189	.196	4.80	4.98	16 AA
S	.0020	.0070	0.05	0.18	
X	.107	.123	2.72	3.12	
D	.337	.344	8.56	8.74	20 AB
S	.0500	.0550	1.270	1.397	
D	.337	.344	8.56	8.74	24 AC
S	.0250	.0300	0.635	0.762	
D	.386	.393	9.80	9.98	28 AD
S	.0250	.0300	0.635	0.762	
X	.271	.287	6.88	7.29	

MAXIM
 PROPRIETARY INFORMATION
 TITLE:
 PACKAGE OUTLINE, QSOP, 150°, .025° LEAD PITCH
 APPROVAL: _____ DOCUMENT CONTROL NO. 21-0055 REV B 1/1

OSOP.EPS

Serially Controlled, Clickless Audio/Video Switches

NOTES

MAX4562/MAX4563

Serially Controlled, Clickless Audio/Video Switches

NOTES

Maxim cannot assume responsibility for use of any circuitry other than circuitry entirely embodied in a Maxim product. No circuit patent licenses are implied. Maxim reserves the right to change the circuitry and specifications without notice at any time.

16 _____ **Maxim Integrated Products, 120 San Gabriel Drive, Sunnyvale, CA 94086 408-737-7600**