

REVISION HISTORY-- ALL SHEETS ARE THE SAME REVISION STATUS

DWG NO RHA.1515 183800019200 SH 1 of 1 REV A

REV	DESCRIPTION	DATE	APPROVED
-----	-------------	------	----------

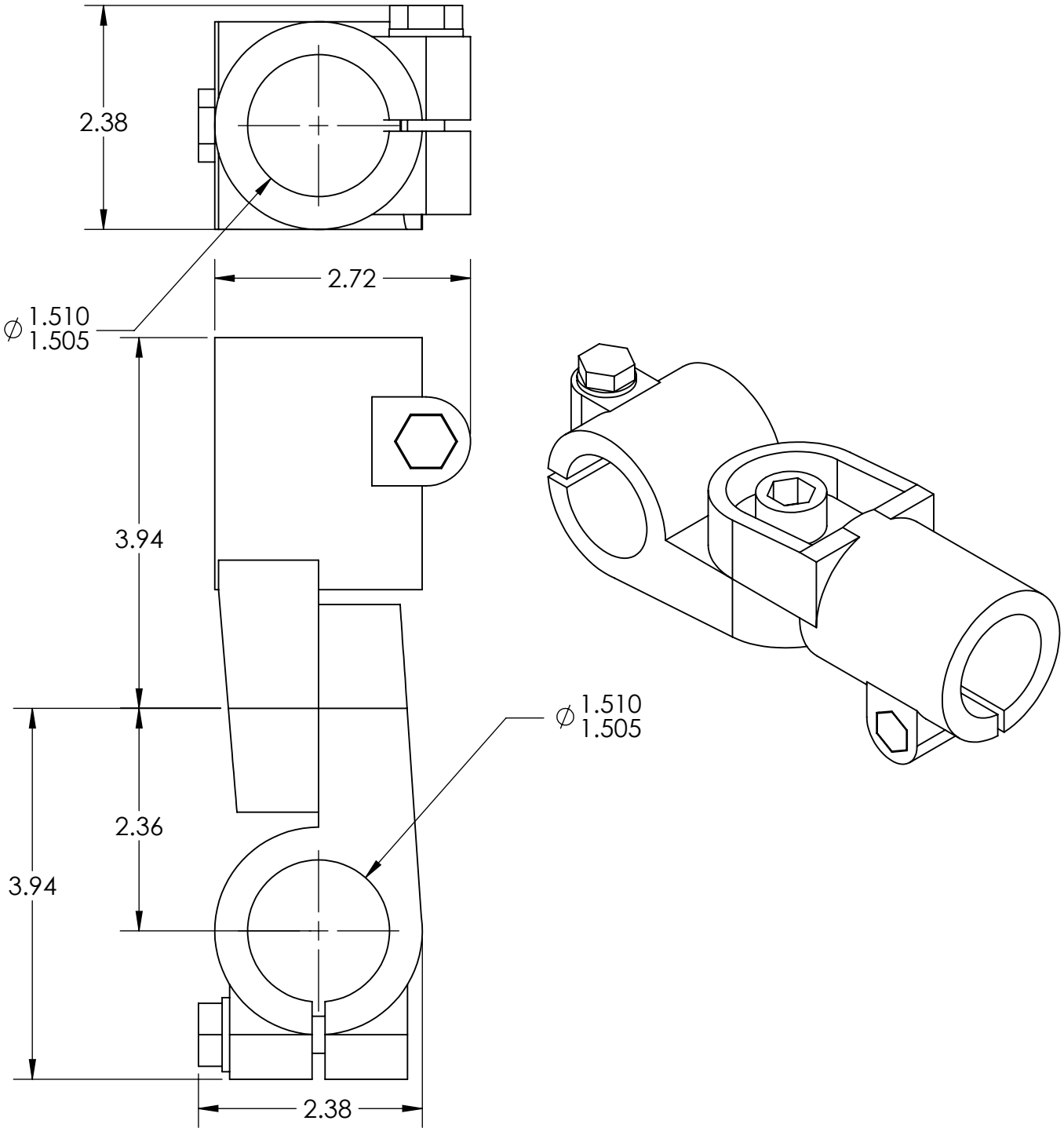

CONFIDENTIAL
 © 2016 Phoenix Mecano Inc.
 This drawing is the property of Phoenix Mecano Inc. and embodies confidential information, trade secret information, and/or know-how which is the property of Phoenix Mecano Inc. By accepting this drawing, the recipient agrees not to provide, or otherwise make available, the drawing, or any information or know-how embodied therein, to any third party without prior written authorization.

UNLESS OTHERWISE SPECIFIED
 DIM ARE IN INCHES
 TOLERANCE:
 ANGLE ± .5°
 1 PL ± .030
 2 PL ± .010
 3 PL ± .005
 INTERPRET DIM AND TOL PER
 ASME Y14.5M-1994
 THIRD ANGLE PROJECTION

DRAWN **Chi Pong**
 APPROVED
 APPROVED

Phoenix Mecano Inc.
 7330 Executive Way
 Frederick, MD 21704
 (301) 696-9411 voice
 (301) 696-9494 fax

PHOENIX
MECANO

TITLE RK Clamp Catalog Drawing			
SIZE A	CAGE CODE 1L9R7	DWG NO RHA.1515 183800019200	REV A
SCALE NTS	DATE 7/14/2016	SHEET 1 of 1	