

1977878-1 ✓ ACTIVE

AMP | AMP CPC

TE Internal #: 1977878-1

Circular Power Connectors, Housing, 600 VDC, Wire-to-Wire, 4 Position, Sealable, Wire & Cable, Plug, Socket, Signal, Black, All Plastic, AMP CPC

[View on TE.com >](#)



Connectors > Power Connectors > Circular Power > Circular Power Connectors > One-Piece Connector, Sealed, CPC Series 1



Connector Product Type: **Housing**

Operating Voltage: **600 VDC**

Connector System: **Wire-to-Wire**

Number of Positions: **4**

Sealable: **Yes**

[All One-Piece Connector, Sealed, CPC Series 1 \(33\)](#)

Features

Product Type Features

Connector Seal & Plug Type	Wire Entry Seal
Connector Product Type	Housing
Connector System	Wire-to-Wire
Sealable	Yes
Connector & Contact Terminates To	Wire & Cable
Connector & Housing Type	Plug
Circular Connector Shell Type	All Plastic

Configuration Features

Reverse Numbering	Without
Number of Positions	4
Number of Power Positions	0
Number of Signal Positions	4



Electrical Characteristics

Operating Voltage	600 VAC
-------------------	---------

Contact Features

Reverse Gender	No
Contact Type	Socket
Contact Protection	With

Mechanical Attachment

Mating Alignment Type	Keyed
Mating Alignment	With
Mating Retention Type	Threaded Coupling
Thread Size	5/8-24 UNEF-2A
Polarization Code	A
Mating Retention	With
Panel Mount Feature	Without

Housing Features

Body Orientation	Straight
Housing Color	Black
Housing Material	Nylon (UV Resistant)
Circular Connector Shell Size	11

Usage Conditions

Operating Temperature Range	-55 – 105 °C[-67 – 221 °F]
Fluid Resistance	Immersion

Operation/Application

Circuit Application	Signal
Shielded	No

Industry Standards

UL Flammability Rating	UL 94V-0
------------------------	----------

Packaging Features

Packaging Quantity	100
Packaging Method	Bag

Other

Power Connectors Comment	With standard coupling.
--------------------------	-------------------------



Product Compliance

[For compliance documentation, visit the product page on TE.com>](#)

EU RoHS Directive 2011/65/EU	Compliant
EU ELV Directive 2000/53/EC	Compliant
China RoHS 2 Directive MIIT Order No 32, 2016	No Restricted Materials Above Threshold
EU REACH Regulation (EC) No. 1907/2006	Current ECHA Candidate List: JUNE 2023 (235) Candidate List Declared Against: JAN 2022 (223) Does not contain REACH SVHC
Halogen Content	Low Halogen - Br, Cl, F, I < 900 ppm per homogenous material. Also BFR/CFR/PVC Free
Solder Process Capability	Not applicable for solder process capability

Product Compliance Disclaimer

This information is provided based on reasonable inquiry of our suppliers and represents our current actual knowledge based on the information they provided. This information is subject to change. The part numbers that TE has identified as EU RoHS compliant have a maximum concentration of 0.1% by weight in homogenous materials for lead, hexavalent chromium, mercury, PBB, PBDE, DBP, BBP, DEHP, DIBP, and 0.01% for cadmium, or qualify for an exemption to these limits as defined in the Annexes of Directive 2011/65/EU (RoHS2). Finished electrical and electronic equipment products will be CE marked as required by Directive 2011/65/EU. Components may not be CE marked. Additionally, the part numbers that TE has identified as EU ELV compliant have a maximum concentration of 0.1% by weight in homogenous materials for lead, hexavalent chromium, and mercury, and 0.01% for cadmium, or qualify for an exemption to these limits as defined in the Annexes of Directive 2000/53/EC (ELV). Regarding the REACH Regulation, the information TE provides on SVHC in articles for this part number is based on the latest European Chemicals Agency (ECHA) 'Guidance on requirements for substances in articles' posted at this URL: <https://echa.europa.eu/guidance-documents/guidance-on-reach>

Compatible Parts



TE Part # CAT-AM71-C83998Y
One-Piece Connector, Sealed, CPC Series 1



TE Part # CAT-AM71-C83998B
CPC Cable Clamps



TE Part # CAT-AM71-C83998
CPC Heat Shrink Strain Reliefs

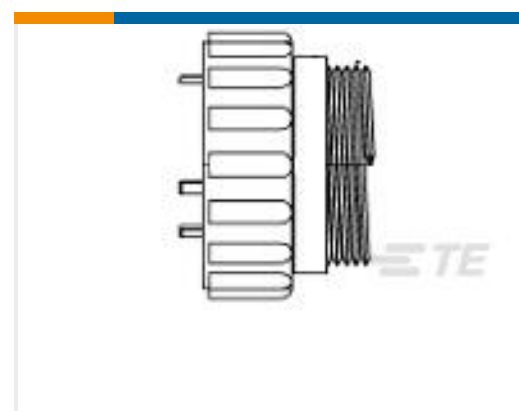

TE Part # 206516-1
CPC PLUG ASSEMBLY SIZE 11-4



TE Part # CAT-AM71-C83998K
Circular Connector, Environmentally Sealed, CPC Series 6



TE Part # CAT-AM71-T98E
Pin and Socket Contacts, Type III, LP



TE Part # CAT-AM71-T98D
Pin and Socket Contacts, Type III, LP EMEA



TE Part # CAT-AM71-T98A
Strip Pin and Socket Contacts, Type III, LP



TE Part # CAT-AM71-T98G
Pin and Socket Contacts, Type III, LP, High Current



TE Part # CAT-AM71-T98
Pin and Socket Contacts, Type II



TE Part # CAT-AM71-T98B
Strip Pin and Socket Contacts, Type III



TE Part # CAT-AM71-T98F
Strip Pin and Socket Contacts, Type III, High Current



TE Part # CAT-AM71-C83998O
Pin and Socket Contacts, CPC MIL-C-5015



TE Part # 81665-3
ECONOSEAL, FLANGE GASKET



TE Part # 91542-1
CCII TYPE III+ PIN SKT 24-22 ASSY



TE Part # 91519-1
CCII TYPE III+ PIN SKT 18-14 ASSY



TE Part # 91505-1
CCII TYPE III+ 24-16 ASSY



TE Part # 58495-1
PRO CRIMPER ASSY MULTIMATE



TE Part # 91523-1
CCII TYPE III+ PIN SKT 24-16 ASSY



TE Part # 91521-1
CCII TYPE III+ PIN SKT 18-14 ASSY

Also in the Series | AMP CPC



Circular Connector Adapters(7)



Circular Connector Caps & Covers(16)



Circular Connector Hardware(3)



Circular Connector Keying Plugs(2)



Circular Power Connectors(459)



Connector Backshells(56)



Connector Seals & Cavity Plugs(36)



Connector Strain Relief(6)



Insertion & Extraction Tools(1)



Power Contacts(6)

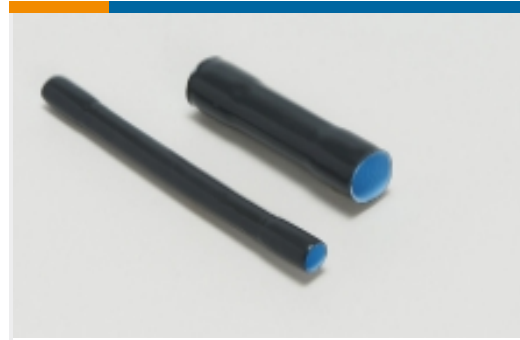

Sealing Sleeves(2)

Customers Also Bought



TE Part #66359-9
Strip Pin and Socket Contacts, Type III



TE Part #487526-6
007 HOUSING FFC RCPT 100CL SR



TE Part #1-66598-2
III+ SKT,18-14,TIN ,STRIP



TE Part #207489-1
FLEXIBLE CABLE BOOT, SIZE 11

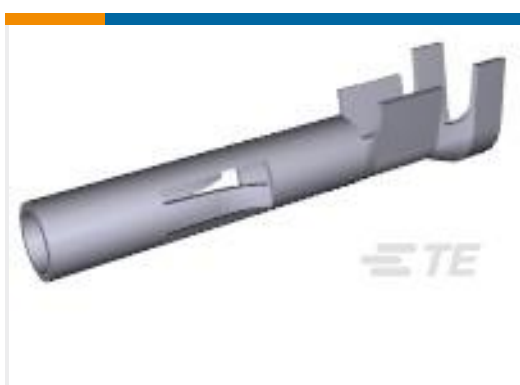

TE Part #350550-2
UMNL SOK 20-14 AU/BR L/P



TE Part #130014
TERM, R, PG, 22-16, M5



TE Part #1-350777-1
02P UMNL V0 PLUG HSG BROWN



TE Part #1747995-1
GHC EYELET 6.2 3POS PLUG
HOUSING NATURAL

Documents

Product Drawings

SLD CPC PLUG ASY,11-4,STD SEX, UV RESIST

English

CAD Files

3D PDF

3D

Customer View Model

ENG_CVM_CVM_1977878-1_A.2d_dxf.zip

1977878-1

Circular Power Connectors, Housing, 600 VDC, Wire-to-Wire, 4 Position, Sealable, Wire & Cable, Plug, Socket, Signal, Black, All Plastic, AMP CPC



English

Customer View Model

[ENG_CVM_CVM_1977878-1_A.3d_igs.zip](#)

English

Customer View Model

[ENG_CVM_CVM_1977878-1_A.3d_stp.zip](#)

English

By downloading the CAD file I accept and agree to the [Terms and Conditions](#) of use.

Product Specifications

[Connector, Circular Plastic](#)

English

[Product Specification](#)

English