

PAGE 1/2

ISSUE 11-04-17

SERIE : DPDT

PART NUMBER : R577043035

RF CHARACTERISTICS

Frequency range : **0 - 3 GHz**
Impedance : **50 Ohms**

Frequency (GHz)	DC - 1	1 - 2	2 - 3
VSWR max	1.15	1.20	1.25
Insertion loss max	0.15 dB	0.20 dB	0.25 dB
Isolation min	85 dB	80 dB	75 dB
Average power (*)	700 W	500 W	400 W

ELECTRICAL CHARACTERISTICS

Actuator : **LATCHING**
Nominal current ** : **125 mA**
Actuator voltage (Vcc) : **28V (24 to 30V) / NEGATIVE COMMON**
Terminals : **9 pins D-SUB male connector**
Indicator rating : **1 W / 30 V / 100 mA**

MECHANICAL CHARACTERISTICS

Connectors : **N female per MIL-C 39012**
Life : **2.5 million cycles**
Switching Time*** : **< 15 ms**
Construction : **Splashproof**
Weight : **< 215 g**

ENVIRONMENTAL CHARACTERISTICS

Operating temperature range : **-40°C to +85°C**
Storage temperature range : **-55°C to +85°C**

(* Average power at 25°C per RF Path)

(** At 25° C ±10%)

(*** Nominal voltage ; 25° C)



PAGE 2/2

ISSUE 11-04-17

SERIE : DPDT

PART NUMBER : R577043035

DRAWING

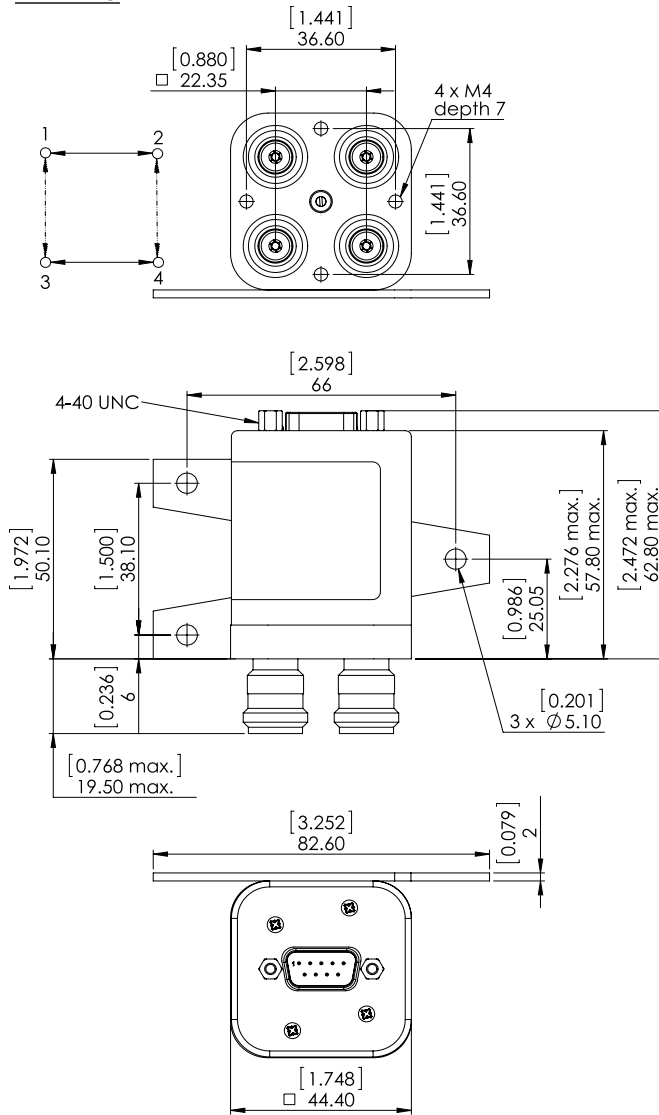

General tolerances : ±0,5 mm [0,02 in]



LABEL

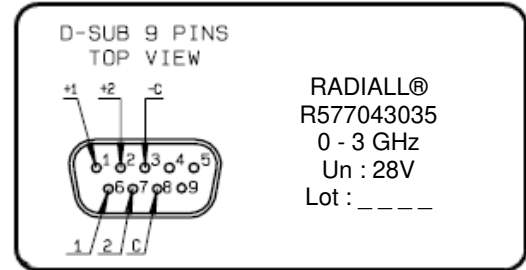

SCHEMATIC DIAGRAM

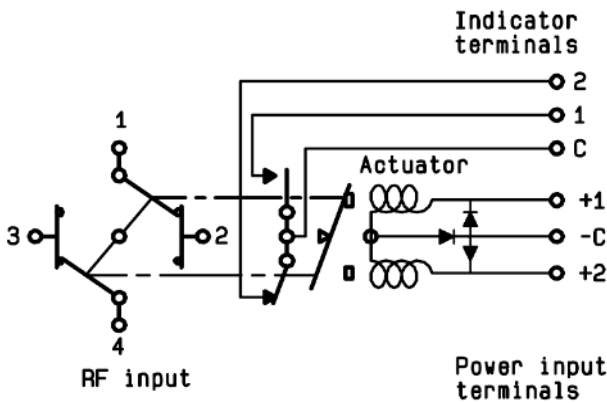

Voltage	RF Continuity	Ind.
-C +1	1 ↔ 3 / 2 ↔ 4	C.1
-C +2	1 ↔ 2 / 3 ↔ 4	C.2