



MTA 156

TE Internal #: 640643-4

PCB Connector Covers, 4 Position, .156 in [3.96 mm] Centerline, Polyester, Standard Product Profile, Dust Cap, -55 – 105 °C [-67 – 221 °F], MTA 156

[View on TE.com >](#)

Connectors > PCB Connectors > PCB Connector Accessories > PCB Protection & Strain Relief > PCB Connector Covers



Number of Positions: **4**

Centerline (Pitch): **3.96 mm [ .156 in ]**

Primary Product Material: **Polyester**

Product Profile: **Standard**

Connector Cover Type: **Dust Cap**

**Features**

**Product Type Features**

Product Profile	Standard
Connector Cover Type	Dust Cap

**Configuration Features**

Number of Positions	4
---------------------	---

**Body Features**

Primary Product Color	Natural
Primary Product Material	Polyester

**Housing Features**

Centerline (Pitch)	3.96 mm [.156 in]
--------------------	-------------------

**Usage Conditions**

Compatible With IDC Installation Type Connector	Feed Thru
Operating Temperature Range	-55 – 105 °C [-67 – 221 °F]

**Industry Standards**

--	--



UL Flammability Rating	UL 94V-0
------------------------	----------

### Product Compliance





[For compliance documentation, visit the product page on TE.com>](#)

EU RoHS Directive 2011/65/EU	Compliant
EU ELV Directive 2000/53/EC	Compliant
China RoHS 2 Directive MIIT Order No 32, 2016	No Restricted Materials Above Threshold
EU REACH Regulation (EC) No. 1907/2006	Current ECHA Candidate List: JUNE 2023 (235) Candidate List Declared Against: JUNE 2023 (235) Does not contain REACH SVHC
Halogen Content	Not Low Halogen - contains Br or Cl > 900 ppm.
Solder Process Capability	Not applicable for solder process capability

#### Product Compliance Disclaimer

This information is provided based on reasonable inquiry of our suppliers and represents our current actual knowledge based on the information they provided. This information is subject to change. The part numbers that TE has identified as EU RoHS compliant have a maximum concentration of 0.1% by weight in homogenous materials for lead, hexavalent chromium, mercury, PBB, PBDE, DBP, BBP, DEHP, DIBP, and 0.01% for cadmium, or qualify for an exemption to these limits as defined in the Annexes of Directive 2011/65/EU (RoHS2). Finished electrical and electronic equipment products will be CE marked as required by Directive 2011/65/EU. Components may not be CE marked. Additionally, the part numbers that TE has identified as EU ELV compliant have a maximum concentration of 0.1% by weight in homogenous materials for lead, hexavalent chromium, and mercury, and 0.01% for cadmium, or qualify for an exemption to these limits as defined in the Annexes of Directive 2000/53/EC (ELV). Regarding the REACH Regulation, the information TE provides on SVHC in articles for this part number is based on the latest European Chemicals Agency (ECHA) 'Guidance on requirements for substances in articles' posted at this URL: <https://echa.europa.eu/guidance-documents/guidance-on-reach>

### Compatible Parts

 <p>TE Part # CAT-103156-WBHSM Receptacle Housing: Wire-to-Board, with Mating Alignment, SL156</p>	 <p>TE Part # CAT-103156-WBHSN Receptacle Housing: Wire-to-Board, no Mating Alignment, SL 156</p>	 <p>TE Part # 3-641435-4 04P MTA156 CONN ASSY ORNG</p>	 <p>TE Part # 3-640433-4 04P MTA156 CONN ASSY 22AWG RED</p>
---	--	---	--



TE Part # 3-640602-4  
04P MTA156 CONN ASSY 24AWG LF



TE Part # 3-643819-4  
04P MTA156 CONN ASSY 22AWG RED



TE Part # 3-644613-4  
04P MTA156 HDR RA PO WO PEG LF



TE Part # 3-643818-4  
04P MTA156 CONN ASSY 20AWG YEL



TE Part # 3-640429-4  
04P MTA156 CONN ASSY 24AWG WHT



TE Part # 3-641436-4  
04P MTA156 CONN ASSY LF



TE Part # 3-640427-4  
04P MTA156 CONN ASSY 20AWG YEL



TE Part # 640387-4  
04P MTA156 HDR ASSY SQ R/A



TE Part # 3-644461-4  
04P MTA156 CONN ASSY 18AWG LF



TE Part # 640389-4  
04P MTA156 HDR ASSY SQ R/A F/L



TE Part # 3-640428-4  
04P MTA156 CONN ASSY 22AWG RED



TE Part # 3-641437-4  
04P MTA156 PSTD CONN ASSY RED



TE Part # 3-641208-4  
04P MTA156 HDR ASSY FL ST 30AU



TE Part # 3-641209-4  
04P MTA156 HDR ASSY FL ST LF



TE Part # 644753-4  
04P MTA156 HDR ASSY RN STR F/L



TE Part # 3-640426-4  
04P MTA156 CONN ASSY 18AWG ORA

Also in the Series | **MTA 156**



Insertion & Extraction Tools(1)

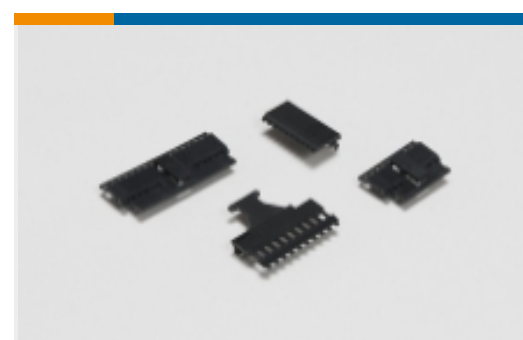

PCB Connector Covers(88)



PCB Connector Keying(2)

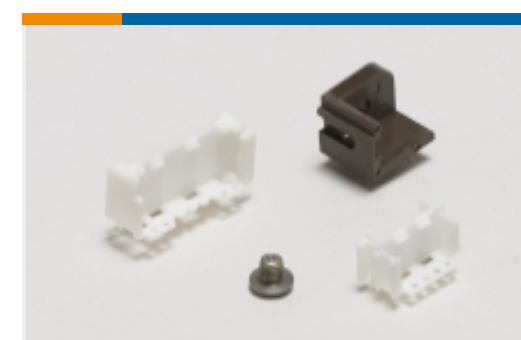

PCB Connector Mounting(1)



PCB Headers & Receptacles(316)

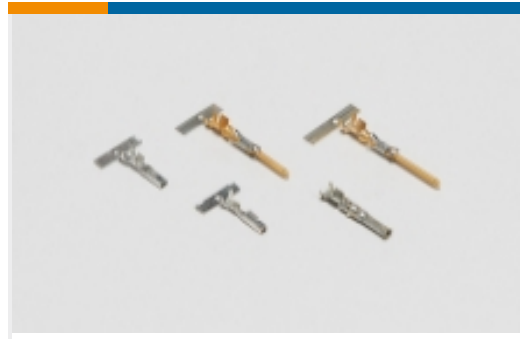

Power Contacts(3)



Rectangular Power Connectors(699)



Standard Rectangular Connectors(340)



Wire-to-Board Connector Contacts(3)

## Customers Also Bought



TE Part #1-2201196-0  
0.4 STACKING CONN H0.98 PLUG ASSEMBLY

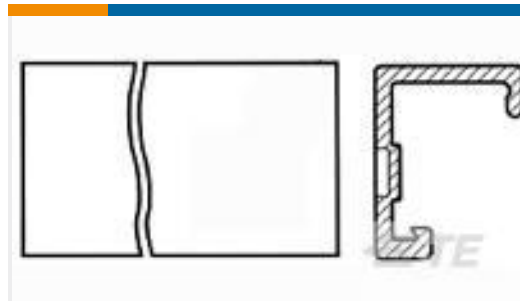

TE Part #640551-9  
09P MTA156 COVER

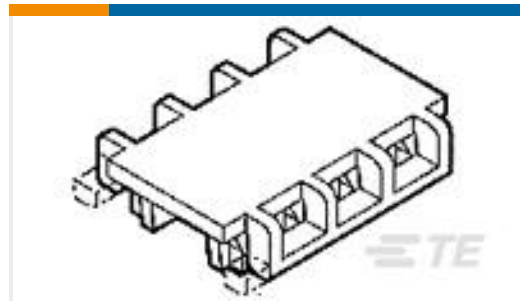

TE Part #643071-4  
04P MTA156 FD-THRU COVER



TE Part #2-6609107-2  
PS000SS30=C1057

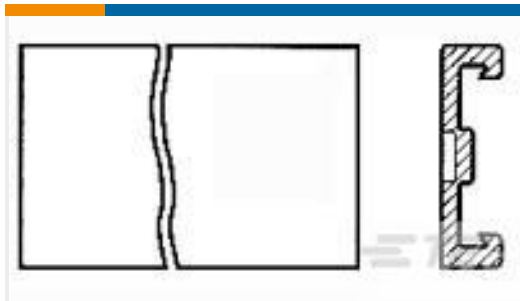

TE Part #640643-8  
08P MTA156 COVER F/T

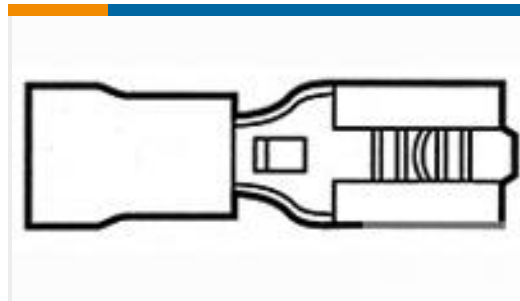

TE Part #5-160483-1  
187 PIDG FASTON REC

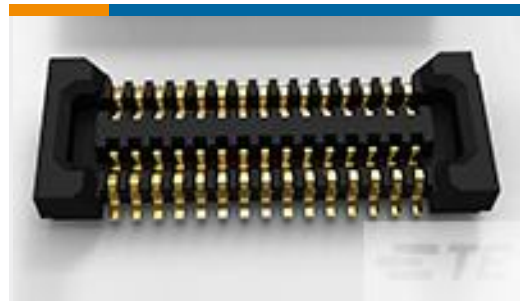

TE Part #1-2201197-0  
0.4 STACKING CONN H0.98 REC ASSEMBLY



TE Part #3-640600-5  
05P MTA156 CONN ASSY 20AWG LF



TE Part #3-644466-8  
08P MTA156 CONN ASSY 20AWG YEL

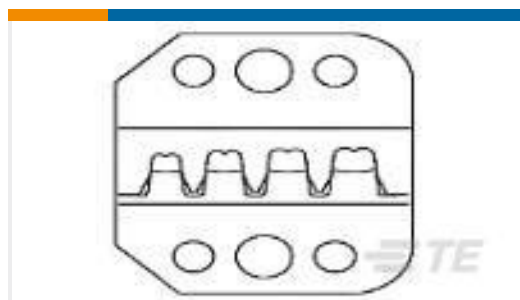

TE Part #58530-2  
PROCRIMPER DIE

## Documents



## Product Drawings

### 04P MTA156 COVER F/T

English

## CAD Files

### 3D PDF

3D

#### Customer View Model

[ENG\\_CVM\\_CVM\\_640643-4\\_N.2d\\_dxf.zip](#)

English

#### Customer View Model

[ENG\\_CVM\\_CVM\\_640643-4\\_N.3d\\_igs.zip](#)

English

#### Customer View Model

[ENG\\_CVM\\_CVM\\_640643-4\\_N.3d\\_stp.zip](#)

English

#### Customer View Model

[ENG\\_CVM\\_640643-4\\_R.3d\\_igs.zip](#)

English

#### Customer View Model

[ENG\\_CVM\\_640643-4\\_R.3d\\_stp.zip](#)

English

#### Customer View Model

[ENG\\_CVM\\_640643-4\\_R.2d\\_dxf.zip](#)

English

### 3D PDF

English

By downloading the CAD file I accept and agree to the [Terms and Conditions](#) of use.

## Product Specifications

### Application Specification

Japanese

### Application Specification

English

### MTA 156 Ribbon Cable Connector Assemblies (English And Spanish)

English

### MTA 156 Ribbon Cable Connector Assemblies (English And Spanish)

Japanese