

QT-Brightek Lamp Series

3mm Round Lamp

Part No.: QBL7YG60D

Table of Contents:

Introduction	3
Electrical / Optical Characteristic (Ta=25 °C)	4
Absolute Maximum Rating	4
Characteristic Curves.....	5
Labeling	6
Ordering Information	6
Revision History	7
Disclaimer	7

Introduction

Feature:

- Green diffused lens
- Green color (570nm)
- 3mm round lamp
- GaP technology
- Viewing angle: 60° typ.

Description:

These super bright 3mm round type lamps with 5.08mm lens height are suitable for all applications requiring higher brightness.

Application:

- General purpose indicator application
- Electronic signs and electronics board
- LED lighting

Certification & Compliance:

- ISO9001
- RoHS Compliant



Dimension:

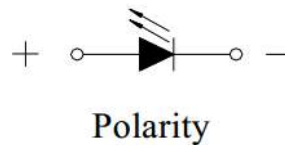
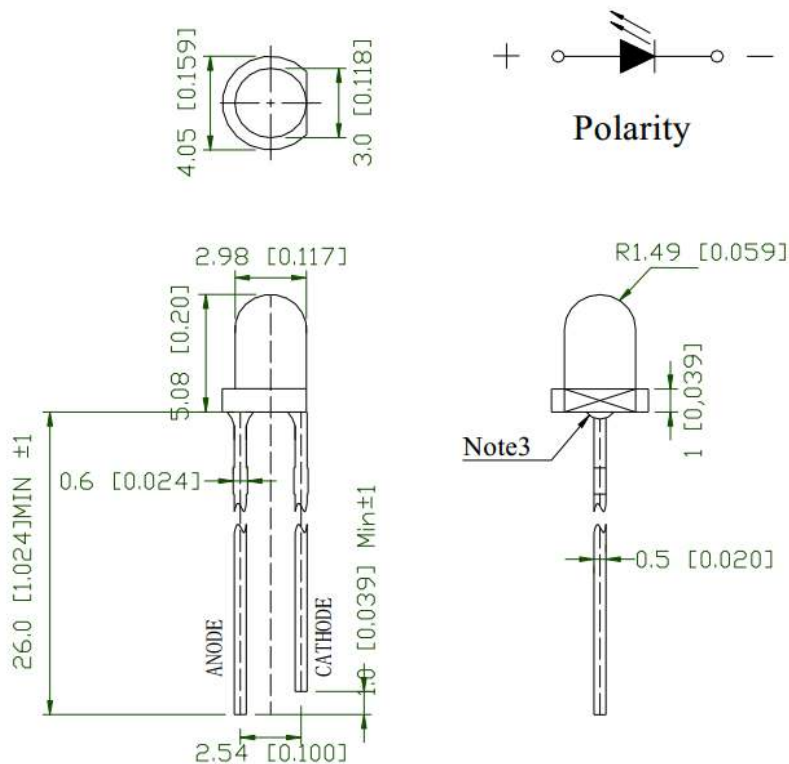

Units: mm / general tolerance = +/-0.25mm unless otherwise specified

Electrical / Optical Characteristic (Ta=25 °C)

Product	Color	I _F (mA)	V _F (V)		λ _d (nm)	λ _p (nm)	I _V (mcd)	
			Typ.	Max.	Typ.	Typ.	Min.	Typ.
QBL7YG60D	Green	10	2.0	2.3	570	565	9	25
		20	2.2	2.6			20	45

Absolute Maximum Rating

Material	P _d (mW)	I _F (mA)	I _{FP} (mA)*	V _R (V)	T _{OP} (°C)	T _{ST} (°C)	T _{SO L} (°C)**
GaP	78	30	100	5	-40 to +85	-40 to +100	260

*1/10 Duty Cycle, 0.1ms Pulse Width

**Wave Soldering for no more than 3 sec @ 260 °C

Characteristic Curves

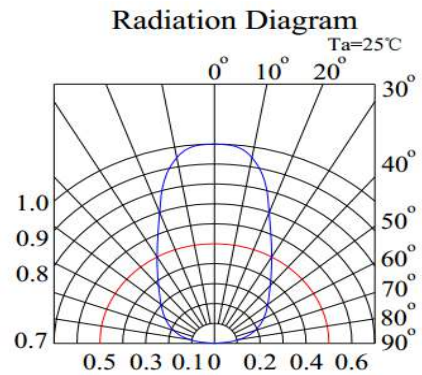
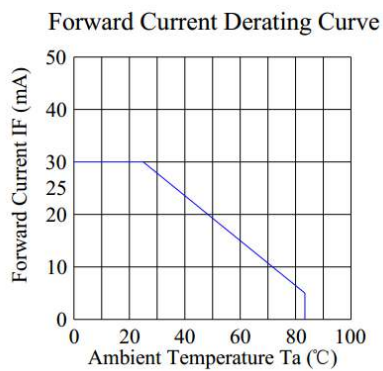
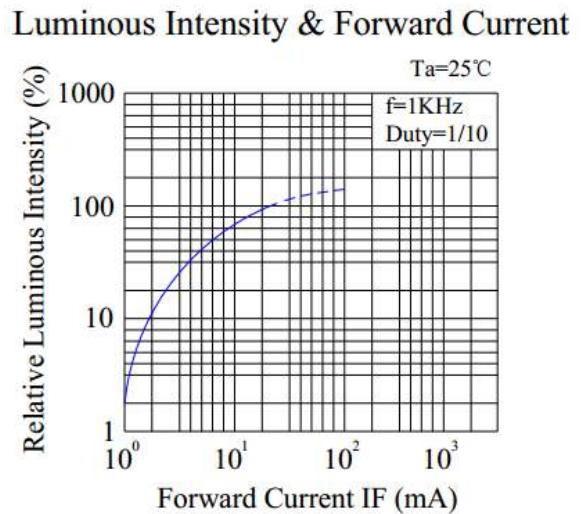
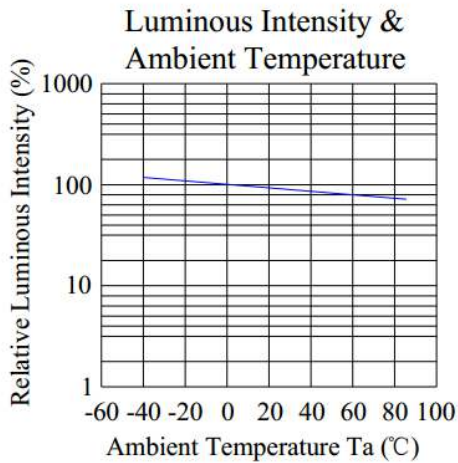
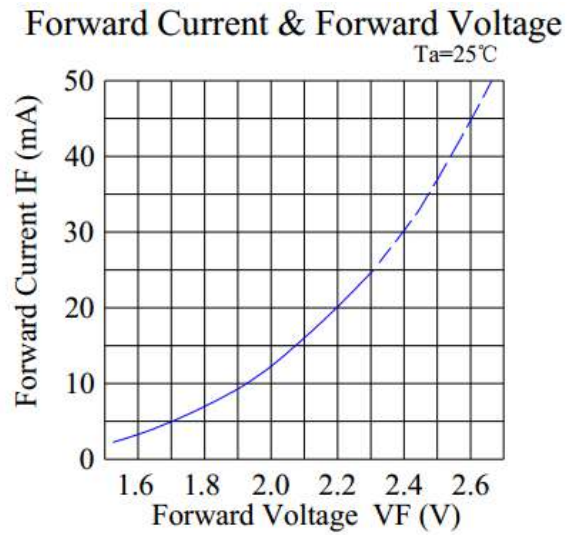
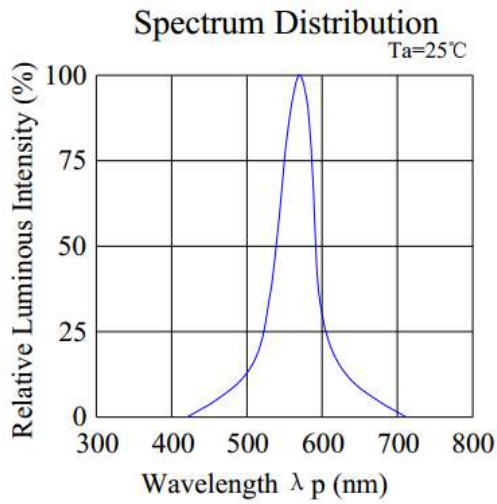

Labeling

Part No: _____

Customer P/N: _____

Item: _____

Q'ty: _____

LOT NO: _____

Date: _____

Made in China**Ordering Information**

Part #	Orderable Part #	Spec Range	Quantity per bag (Bulk Pack)
QBL7YG60D	QBL7YG60D	I _v =25mcd typ. @ I _F =10mA, λ _d : 570nm typ.	500pcs

Revision History

Description:	Revision #	Revision Date
New Release of QBL7YG60D	V1.0	07/20/2017
Update color description	V1.1	08/04/2022

Disclaimer

QT-BRIGHTTEK reserves the right to make changes without further notice to any products herein to improve reliability, function or design. QT-BRIGHTTEK does not assume any liability arising out of the application or use of any product or circuit described herein; neither does it convey any license under its patent rights, nor the rights of others.

Life Support Policy

QT-BRIGHTTEK's products are not authorized for use as critical components in life support devices or systems without the express written approval of QT-BRIGHTTEK. As used herein:

1. Life support devices or systems are devices or systems which, (a) are intended for surgical implant into the body, or (b) support or sustain life, and (c) whose failure to perform when properly used in accordance with instructions for use provided in the labeling, can be reasonably expected to result in a significant injury of the user.
2. A critical component in any component of a life support device or system whose failure to perform can be reasonably expected to cause the failure of the life support device or system, or to affect its safety or effectiveness.