



# Connectivity Solutions for Industrial Applications



## Connectivity Solutions for Industrial Applications

### **Terminals, splices and cable accessories**

Insulated terminals and splices	4
Uninsulated terminals and splices	17
Identification systems	21
Cable ties and spiral cable wrap	27

### **Industrial relays**

Power relays	29
--------------	----

### **Connectors for industrial applications**

Pin and socket connector systems	40
I/O connectors	50
Circular connectors	54
Solar connector systems	58
Connectors for lighting industry	64
Heavy-duty industrial connectors	65

## PLASTI-GRIP terminals and splices

Insulated terminals and splices

### FEATURES

- A large number of our PLASTI-GRIP products are UL File E 13288 listed and certified according to CSA File LR 7189
- The majority of products are available in small packs or bulk
- Operating temperature: max. 105°C
- Operating voltage: max. 600 V
- Insulating sleeve: Nylon, according to UL 94V-2
- Contact body and sleeve: Electrolytic copper, tin-plated
- UL File E13288 and CSA LR 7189 listed

### APPLICATION

- Repair and service
- Lighting installations
- Control cabinet and switchgear engineering

### BENEFITS

- The basic material is a highly conductive copper, electrolytically tin-plated, for optimal corrosion protection
- The processable wire range is embossed in the splice tongue
- The multiple inner grooving in the crimp area ensures maximum electrical contact and high tensile strength
- The copper sleeve provides total insulation support and allows bending in any direction without damaging the wire insulation or conductor
- The insulating sleeve and processing tools are colour coded appropriate to the wire size for easier assignment



- The conical sleeve serves for easier conductor insertion
- The coloured insulating sleeve facilitates assignment to the respective wire range
- Grooves inside the wire sleeve ensure high tensile strength and current transfer
- The insulating sleeve protects and support the wire after crimping. The widened insulating sleeve allows a large number of insulation diameters



### Ring tongue terminals



Wire size [mm <sup>2</sup> ]	Stud size	W [mm]	L [mm]	Max. insulation diameter [mm]	Part number	
					Bulk pack	Small pack
0.25-1.60	M2	5.54	17.37	● 3.56	34140	9-1377172-2
	M3	5.54	17.37	● 3.56	34141	9-1377172-3
	M3	7.14	20.55	● 3.56	34143	–
	M3.5	5.54	17.37	● 3.56	34142	9-1377172-4
	M3.5	7.14	20.55	● 3.56	34144	–
	M4	7.14	20.55	● 3.56	34145	9-1377172-5
	M4	7.92	21.74	● 3.56	34148	9-1377172-6
	M5	8.00	21.80	● 3.56	130014	9-1377172-7
	M6	11.91	27.69	● 3.56	34150	9-1377172-9
	M6	11.91	27.81	● 3.56	130054	9-1377172-8
1.00-2.60	M8	11.91	27.69	● 3.56	34151	1377173-1
	M3.5	6.35	18.16	● 4.32	34158	1377173-3
	M4	8.71	22.12	● 4.32	34160	1377173-4
	M5	8.70	22.30	● 4.90	130102	1377173-5
	M6	11.91	27.69	● 4.32	34162	1377173-6
	M6	11.90	27.90	● 4.90	130126	1377173-7
	M8	11.91	27.69	● 4.32	34163	1377173-8
2.60-6.60	M10	16.70	31.60	● 4.90	160136	5-1377175-6
	M4	9.53	27.89	● 6.35	34853	1377173-9
	M5	9.50	27.90	● 6.40	160292	1-1377173-0
	M6	12.70	30.07	● 6.78	165035	5-1377175-4
	M8	12.70	30.10	● 6.30	160296	1-1377173-2
	M10	15.09	36.40	● 6.30	160300	1-1377173-3
M12	19.05	40.49	● 6.35	34837	–	

### Spade tongue terminals



Wire size [mm <sup>2</sup> ]	Stud size	W [mm]	L [mm]	Max. insulation diameter [mm]	Part number	
					Bulk pack	Small pack
0.25-1.60	M2.5	5.54	19.91	● 4.06	165004	1-1377173-4
	M3.5	6.35	21.79	● 3.56	327043	1-1377173-5
	M3.5	7.54	19.43	● 3.56	320665	1-1377173-6
	M4	9.53	23.37	● 3.56	34155	1-1377173-8
	M4	7.11	21.11	● 3.61	165008	1-1377173-9
	M4.5	9.53	23.37	● 3.56	34156	2-1377173-0
1.00-2.60	M3.5	7.54	19.43	● 3.68	322994	2-1377173-6
	M3.5	9.78	23.37	● 4.32	34165	2-1377173-7
	M4	7.54	19.43	● 4.32	326741	2-1377173-9
	M4	9.78	23.37	● 4.32	34166	3-1377173-0
	M4	6.40	20.00	● 4.95	165012	2-1377173-8
2.60-6.60	M5	9.80	23.70	● 4.95	160171	3-1377173-1
	M4	8.00	31.45	● 6.40	165015	3-1377173-6
	M4.5	10.31	32.60	● 6.40	165017	3-1377173-7
M6	13.46	33.19	● 6.40	165019	3-1377173-8	

Flanged spade tongue  
terminals

Wire size [mm <sup>2</sup> ]	Stud size	W [mm]	L [mm]	Max. insulation diameter [mm]	Part number	
					Bulk pack	Small pack
0.25-1.60	M3.5	7.52	19.02	● 3.56	322249	2-1377173-1
	M4	10.57	21.39	● 3.56	324169	2-1377173-2
	M4.5	7.52	19.02	● 3.56	328516	2-1377173-3
1.00-2.60	M4	7.47	19.02	● 4.90	160212	3-1377173-4
	M4.5	7.47	19.02	● 4.39	160213	3-1377173-5
2.60-6.60	M4	10.57	25.83	● 5.84	324172	3-1377173-9
	M4.5	10.57	25.83	● 6.35	52856	4-1377173-0

## Pin terminals



Wire size [mm <sup>2</sup> ]	Pin length [mm]	W [mm]	L [mm]	Max. insulation diameter [mm]	Part number	
					Bulk pack	Small pack
0.25-1.60	6.71	1.80	20.50	● 3.71	165143	4-1377173-1
	9.91	1.80	23.80	● 3.71	165167	4-1377173-2
1.00-2.60	6.71	1.80	20.70	● 4.90	165075	4-1377173-5
	9.91	1.80	23.70	● 4.90	165171	4-1377173-7
2.60-6.60	9.91	2.60	29.21	● 6.40	165085	4-1377173-9

## Blade terminals



Wire size [mm <sup>2</sup> ]	Pin length [mm]	W [mm]	L [mm]	Max. insulation diameter [mm]	Part number	
					Bulk pack	Small pack
0.25-1.60	8.10	2.95	23.00	● 3.60	131443	4-1377173-3
1.00-2.60	8.10	2.95	23.00	● 4.90	131444	4-1377173-8
2.60-6.60	8.40	4.20	29.40	● 6.40	131445	5-1377173-0

## Butt splices



Wire size [mm <sup>2</sup> ]	L [mm]	Max. insulation diameter [mm]	Part number	
			Bulk pack	Small pack
0.10-0.40	15.75	● 2.03	321026	5-1377173-1
0.25-1.60	27.33	● 3.56	34070	5-1377173-2
1.00-2.60	27.05	● 4.32	34071	5-1377173-3
2.60-6.60	29.46	● 5.84	34072	5-1377173-4

## Parallel splices



Wire size [mm <sup>2</sup> ]	L [mm]	Max. insulation diameter [mm]	Part number	
			Bulk pack	Small pack
0.25-1.60	19.30	● 3.56	34132	5-1377173-5
1.00-2.60	19.30	● 4.32	34134	5-1377173-6
2.60-6.60	22.10	● 5.84	34136	5-1377173-7

## Premium tools



Description	Wire range [mm <sup>2</sup> ]	For PLASTI-GRIP Terminals and splices	Part number
Heavy Head hand tool	2.60-6.60	Ring tongue terminals, butt splices Spade tongue terminals, flanged spade tongue terminals, pin terminals	59239-4
Double Action hand tool	1.00-5.60		47387
Double Action hand tool	0.50-1.60		47386
Double Action hand tool	0.10-0.40	Butt splices	46121
TETRA-CRIMP hand tool	0.25-6.60	Ring tongue terminals, butt splices Spade tongue terminals, flanged spade tongue terminals, pin terminals	59824-1

## Commercial tools



Description	Wire range [mm <sup>2</sup> ]	For PLASTI-GRIP Terminals and splices	Part number
CERTI-LOK hand tool with locator, without die		Ring tongue terminals Butt splices Spade tongue terminals Pin terminals Blade terminals	169400
CERTI-LOK die	0.25-6.60		169404
SDE PRO-CRIMPER III hand tool without locator and die			354940-1
SDE PRO-CRIMPER III die	0.25-6.60		58423-1

## Service tools



Description	Wire range [mm <sup>2</sup> ]	For PLASTI-GRIP Terminals and splices	Part number
SUPERCHAMP II hand tool	0.25-6.60	All	169060-8
Service Line hand tool	0.50-6.00	All	2217520-1

## PIDG terminals and splices

Insulated terminals and splices

### FEATURES

- The majority of products are available in small packs or bulk
- Operating temperature: max. 105°C
- Operating voltage: max. 300 V
- Insulating sleeve: Nylon, according to UL 94V-2
- Contact body and sleeve: Electrolytic copper, tin-plated
- UL File E13288 and CSA LR 7189 listed

### APPLICATION

- Repair and service
- Lighting installations
- Control cabinet and switchgear engineering

### BENEFITS

- ♦ The basic material is a highly conductive copper, electrolytically tin-plated, for optimal corrosion protection
- ♦ The processable wire range is embossed in the splice tongue
- ♦ The multiple inner grooving in the crimp area ensures maximum electrical contact and high tensile strength
- ♦ The copper sleeve provides total insulation support and allows bending in any direction without damaging the wire insulation or conductor
- ♦ The insulating sleeve and processing tools are colour coded appropriate to the wire size for easier assignment
- ♦ PIDG cable lugs and connections conform to the requirements of MIL-T-7928
- ♦ A large number of our PIDG products are UL File E 13288 listed and certified according to CSA File LR 7189



- 1 The conical sleeve serves for easier conductor insertion
- 2 The nylon insulating sleeve offers high dielectric strength. The colour coding corresponds to the wire size
- 3 Grooves inside the wire sleeve ensure high tensile strength and current transfer
- 4 The copper sleeve provides optimal insulation support



### Ring tongue terminals



Wire size [mm <sup>2</sup> ]	Stud size	W [mm]	L [mm]	Max. insulation diameter [mm]	Part number	
					Bulk pack	Small pack
0.10-0.40	M2.5	5.16	16.41	● 2.08	323914	8-1856389-6
	M3.5	6.35	18.8	● 2.08	326875	–
	M4	6.35	18.8	● 2.08	323916	6-1377173-5
	M4.5	6.35	19.43	● 2.08	324075	–
0.25-1.60	M2.5	5.54	17.07	● 3.65	31880	6-1377173-6
	M3.5	5.54	17.07	● 3.56	36150	6-1377173-7
	M4	7.92	21.44	● 3.56	31890	6-1377173-8
	M5	7.92	21.60	● 3.56	130008	6-1377173-9
	M6	11.91	27.38	● 3.56	31894	7-1377173-0
	M6	11.91	27.50	● 3.56	130046	8-1856387-4
1.00-2.60	M2.5	6.35	17.86	● 4.32	328996	–
	M3.5	6.35	17.86	● 4.32	320619	7-1377173-2
	M4	8.71	21.82	● 4.32	320565	7-1377173-3
	M5	8.71	21.94	● 3.80	130090	–
	M5	8.71	21.94	● 4.30	130094	7-1377173-4
	M6	11.91	27.38	● 4.32	321045	7-1377173-5
	M8	11.91	27.38	● 4.32	328998	7-1377173-6
	M8	11.91	27.38	● 4.32	328998	7-1377173-6
2.60-6.60	M4	9.53	27.51	● 5.84	320568	–
	M4	9.53	27.51	● 6.35	35108	7-1377173-7
	M5	9.53	27.68	● 6.35	130171	7-1377173-8
	M6	13.49	33.58	● 5.84	320569	–
	M6	13.49	33.58	● 6.35	35110	–
	M8	13.49	33.58	● 5.84	320576	–
	M8	13.49	33.58	● 6.35	35111	–
	M12	19.05	40.49	● 5.84	323784	–
M12	19.05	40.49	● 6.35	35151	–	

## Spade tongue terminals



Wire size [mm <sup>2</sup> ]	Stud size	W [mm]	L [mm]	Max. insulation diameter [mm]	Part number	
					Bulk pack	Small pack
0.10-0.40	M2.5	5.16	15.93	● 2.08	321035	–
0.25-1.60	M2	4.62	18.47	● 3.56	328394	–
	M2.5	5.54	17.12	● 3.18	327717	–
	M3	7.54	21.49	● 3.56	34541	8-1377173-5
	M3.5	7.54	19.13	● 3.18	34080	–
	M3.5	7.54	19.13	● 3.56	326861	9-1377173-1
	M4	9.53	23.06	● 3.18	32050	–
	M4	9.53	23.06	● 3.56	32053	8-1377173-7
	M4.5	9.53	23.06	● 3.18	32051	–
1.00-2.60	M4.5	9.53	23.06	● 3.56	32054	8-1377173-9
	M2.5	6.35	20.65	● 4.32	130527	9-1377173-2
	M3.5	9.35	23.06	● 4.32	32058	–
	M3.5	7.54	19.13	● 4.32	35559	9-1377173-4
	M4	9.78	23.06	● 3.81	32056	–
	M4	9.78	23.06	● 4.32	32059	9-1377173-7
	M4.5	9.78	23.06	● 3.81	32057	–
	M4.5	9.78	23.06	● 4.32	32060	–
2.60-6.60	M6	12.07	28.01	● 4.32	130537	9-1377173-9
	M3.5	7.37	24.23	● 5.84	322985	–
	M3.5	7.92	27.81	● 5.84	326859	–
	M4	10.31	27.81	● 5.84	32588	–
	M4	10.31	27.81	● 6.35	35152	–
M4.5	10.31	27.81	● 5.84	32589	–	
M6	13.50	33.00	● 6.40	130625	1377174-6	

## Pin terminals



Wire size [mm <sup>2</sup> ]	W [mm]	L [mm]	Max. insulation diameter [mm]	Part number	
				Bulk pack	Small pack
0.25-1.60	1.80	20.20	● 3.60	165142	1-1377174-0
	1.80	23.20	● 3.60	165168	1-1377174-1
1.00-2.60	1.80	20.30	● 4.30	165046	1-1377174-3
	1.80	23.60	● 4.30	165172	1-1377174-4
2.60-6.60	2.60	29.10	● 6.30	165049	1-1377174-7

## Blade terminals



Wire size [mm <sup>2</sup> ]	W [mm]	L [mm]	Max. insulation diameter [mm]	Part number	
				Bulk pack	Small pack
0.25-1.60	2.95	23.00	● 3.60	131331	1-1377174-2
1.00-2.60	2.92	22.63	● 4.30	131330	1-1377174-6
2.60-6.60	4.10	29.20	● 6.40	131332	–

## Butt splices



Wire size [mm <sup>2</sup> ]	L [mm]	Max. insulation diameter [mm]	Part number	
			Bulk pack	Small pack
0.10-0.25	22.61	● 2.08	323994	1-1377174-9
0.15-0.60	26.29	● 2.54	323975	–
0.25-1.60	32.13	● 3.18	320559	2-1377174-1
1.00-2.60	32.13	● 3.81	320562	2-1377174-2
2.60-6.60	42.06	● 5.59	320570	2-1377174-3

## FASTON receptacles



Wire size [mm <sup>2</sup> ]	for tabs [mm]	W [mm]	L [mm]	Max. insulation diameter [mm]	Part number	
					Bulk pack	Small pack
0.25-1.60	6.3 x 0.8	7.62	22.20	● 3.56	9-160583-2	9-1377174-1
1.00-2.60	6.3 x 0.8	7.62	23.20	● 4.32	9-160313-2	1377175-6
4.00-6.00	6.3 x 0.8	7.62	26.00	● 6.35	160314-2	1377175-9
	5.0 x 0.5	6.35	20.32	● 3.56	640909-1	–
0.30-1.00	5.0 x 0.8	6.35	20.32	● 3.56	640911-1	–
	5.0 x 0.5	6.35	20.32	● 4.32	640913-1	–
	5.0 x 0.8	6.35	20.32	● 4.32	640915-1	–
0.10-0.25	4.8 x 0.5	5.84	17.78	● 2.08	641321-1	–
0.30-1.50	4.8 x 0.5	5.74	20.88	● 3.56	9-160481-1	8-1377174-5
	4.8 x 0.8	5.74	20.88	● 3.56	9-160483-1	8-1377174-7
1.00-2.60	4.8 x 0.5	5.84	21.90	● 4.30	9-160477-2	9-1377174-9
	4.8 x 0.8	5.74	21.90	● 4.30	9-160479-2	1377175-2
0.30-1.50	2.8 x 0.8	3.70	19.80	● 3.50	165566-1	8-1377174-3
	2.8 x 0.5	3.70	19.80	● 3.50	165565-1	8-1377174-1
1.50-2.50	2.8 x 0.5	3.70	19.80	● 4.30	165616-2	9-1377174-5
	2.8 x 0.8	3.70	19.80	● 4.30	165617-2	9-1377174-7

## FASTON flag terminals



Wire size [mm <sup>2</sup> ]	for tabs [mm]	W [mm]	L [mm]	Max. insulation diameter [mm]	Part number	
					Bulk pack	Small pack
0.30-1.00	6.3 x 0.8	15.49	19.30	3.56	156667-1	1-1377175-7
1.20-2.00	6.3 x 0.8	15.49	19.30	4.32	156666-1	1-1377175-8

## FASTON receptacle and tab combination



Wire size [mm <sup>2</sup> ]	for tabs [mm]	W [mm]	L [mm]	Max. insulation diameter [mm]	Part number	
					Bulk pack	Small pack
0.26-1.65	6.3 x 0.8	6.35	23.55	3.56	160834-2	1-1377175-9
1.00-2.50	6.3 x 0.8	6.35	23.45	4.32	9-160463-2	2-1377175-1

## FASTON receptacles



Wire size [mm <sup>2</sup> ]	for tabs [mm]	W [mm]	L [mm]	Max. insulation diameter [mm]	Part number	
					Bulk pack	Small pack
0.30-1.50	6.3 x 0.8	9.2	21.6	3.3	735278	1-1377175-2
1.50-2.50	6.3 x 0.8	9.2	21.6	4	735159	1-1377175-6
2.50-3.00	6.3 x 0.8	9.2	21.6	4	735160	1-1377175-5

## FASTON tabs



Wire size [mm <sup>2</sup> ]	for tabs [mm]	W [mm]	L [mm]	Insulating sleeve colour	Max. insulation diameter [mm]	Part number	
						Bulk pack	Small pack
0.50-1.00	6.3 x 0.8	6.35	23.50	Red	3.30	140896-2	2-1377175-3
1.30-2.60	6.3 x 0.8	6.35	23.50	Blue	4.00	140971-2	2-1377175-4
4.00-6.00	6.3 x 0.8	6.35	28.00	Yellow	5.70	141085-2	2-1377175-5

## SHUR PLUG round pins and sockets

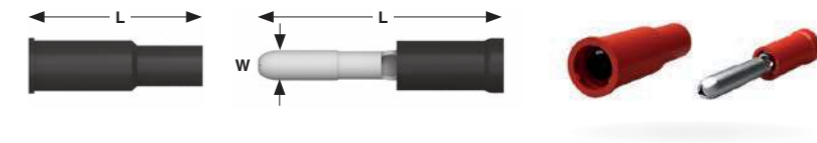

Wire size [mm <sup>2</sup> ]	Description	W [mm]	L [mm]	Max. insulation diameter [mm]	Part number	
					Bulk pack	Small pack
0.25-1.60	Pin	3.96	22.70	3.50	165590-1	2-1377174-5
0.50-1.50	Pin	3.00	24.00	3.40	141462-1	2-1377174-4
0.50-1.50	Socket	3.00	25.00	3.30	141456-1	2-1377174-9
0.50-1.50	Socket	3.96	22.90	2.90	165399-1	5-1377175-5
1.00-2.60	Pin	3.96	20.07	4.32	324225	-
1.00-2.60	Socket	3.96	24.70	4.00	165429-1	3-1377174-2

## Premium tools



## Commercial tools



## Service tools



Description	Wire range [mm <sup>2</sup> ]	For PIDG terminals and splices	Part number
Heavy Head hand tool	2.60-6.60	Ring tongue terminals Butt splices Spade tongue terminals Pin terminals Blade terminals	59239-4
Double Action hand tool	1.00-2.60		47387
Double Action hand tool	0.25-1.60		47386
Double Action hand tool	0.10-0.30		46121
Double Action hand tool	0.15-0.60	Butt splices	47907-1
TETRA-CRIMP hand tool	0.25-6.60	Ring tongue terminals, butt splices Spade tongue terminals, pin terminals, tabs FASTON 6.35/5.0/4.8	59824-1
	0.25-2.60	FASTON 2.8	
Double Action hand tool	0.10-0.25	FASTON 4.8	169485
Double Action hand tool	0.25-1.00	FASTON 2.8	90185-1

Description	Wire range [mm <sup>2</sup> ]	For PIDG terminals and splices	Part number
CERTI-LOK hand tool with locator, without die		Ring tongue terminals Butt splices Spade tongue terminals Pin terminals Blade terminals	169400
CERTI-LOK die	0.25-6.60		169404
SDE PRO-CRIMPER III hand tool without locator and die			354940-1
SDE PRO-CRIMPER III die	0.25-6.60		58423-1
	0.25-2.60	PIDG FASTON	

Description	Wire range [mm <sup>2</sup> ]	For PIDG terminals and splices	Part number
SUPERCHAMP II hand tool	0.25-6.60	All	169060-8

## Service assortments

Minor repairs, maintenance or installations on electrical equipment or machines often have to be carried out reliably and quickly. The terminals and splices required for this purpose are either not always immediately available or must be purchased in large containers. TE Connectivity offers several already assembled service assortments to avoid this. These include a large number of standard terminals and splices for the majority of service applications.

PLASTI-GRIP  
service assortment

Description	Wire size [mm <sup>2</sup> ]	Part number	Quantity	Part number
End splices (nylon)	1.0-6.0	320730	50	165430
6.3 x 0.8 PIDG FASTON Piggy Back receptacle	1.0-2.6	9-160463-2	50	
6.3 x 0.8PIDG FASTON receptacle	1.0-2.6	9-160315-2	50	
PLASTI-GRIP ring tongue terminal	2.7-6.6	165035	50	
PLASTI-GRIP ring tongue terminal	1.0-2.6	34162	50	
PLASTI-GRIP butt splice	1.0-2.6	34071	50	
PLASTI-GRIP pin terminal	1.0-2.6	9-165171-0	50	
PLASTI-GRIP pin terminal	1.0-2.6	9-165075-0	50	
PLASTI-GRIP butt splice	0.25-1.6	34070	50	
PLASTI-GRIP spade tongue terminal	1.0-2.6	326741	50	
PLASTI-GRIP ring tongue terminal	1.0-2.6	130102	50	
PLASTI-GRIP ring tongue terminal	1.0-2.6	34160	50	
PLASTI-GRIP pin terminal	0.25-1.6	165143	50	
PLASTI-GRIP spade tongue terminal	0.25-1.6	165008	50	
PLASTI-GRIP ring tongue terminal	0.25-1.6	34142	50	
Case and partitioning	-	-	1	

## PIDG service assortment



Description	Wire size [mm <sup>2</sup> ]	Part number	Quantity	Part number
FASTON receptacle	1.0-2.6	9-160313-2	50	165154
Spade tongue terminal M6	2.7-6.6	130625	50	
Pin terminal	2.7-6.6	165049	50	
Ring tongue terminal M5	1.0-2.6	130094	50	
Pin terminal	1.0-2.6	165049	50	
Ring tongue terminal M8	2.7-6.6	160298	50	
Ring tongue terminal M4	1.0-2.6	320565	50	
Ring tongue terminal M6	2.7-6.6	165034	50	
Butt splice	2.7-6.6	34072	50	
Butt splice	1.0-2.6	34071	50	
Butt splice	0.25-1.6	34070	50	
Spade tongue terminal M4	0.25-1.6	130517	50	
Spade tongue terminal M3.5	1.0-2.6	320861	50	
Spade tongue terminal M4	1.0-2.6	321233	50	
Pin terminal	0.25-1.6	165142	50	
Pin terminal	1.0-2.6	9-160402-2	50	
Ring tongue terminal M4	0.25-1.6	31890	50	
Ring tongue terminal M3.5	0.25-1.6	36150	50	
Case	-	-	1	

## AMPLISET service assortment



Description	Wire size [mm <sup>2</sup> ]	Part number	Quantity	Part number
PLASTI-GRIP butt splice	0.25-1.6	34070	7	725972
PLASTI-GRIP ring tongue terminal; M3	0.25-1.6	34142	3	
PLASTI-GRIP ring tongue terminal; M5	0.25-1.6	130014	3	
PLASTI-GRIP ring tongue terminal; M2.6	0.25-1.6	165004	3	
PLASTI-GRIP pin terminal, short	0.25-1.6	165413	3	
PLASTI-GRIP pin terminal, long	0.25-1.6	165167	2	
PLASTI-GRIP butt splice	1.0-2.6	34071	5	
PLASTI-GRIP ring tongue terminal; M5	1.0-2.6	130102	3	
PLASTI-GRIP spade tongue terminal; M4	1.0-2.6	34166	2	
PLASTI-GRIP pin terminal	1.0-2.6	165171-1	2	
PLASTI-GRIP ring tongue terminal; M6	1.0-2.6	165035	2	
PLASTI-GRIP ring tongue terminal; M8	1.0-2.6	160296	1	
PLASTI-GRIP spade tongue terminal; M5	2.7-6.6	165017	1	
PLASTI-GRIP pin terminal	2.7-6.6	165085	1	
PE end splice	1.5-6.6	328730	3	
PIDG FASTON receptacle; 6.3 x 0.8	0.25-1.6	9-160583-2	3	
PIDG FASTON receptacle; 6.3 x 0.8	1.0-2.6	9-160313-2	2	
FASTON receptacle, insulated; 6.3 x 0.8	1.0-2.6	735159	2	
FASTON receptacle and tab combination; 6.3 x 0.8	1.0-2.6	9-160463-2	2	
PIDG FASTON receptacle; 6.3 x 0.8	2.7-6.6	160314-2	1	
SUPER CHAMP hand tool	-	169060-8	1	



## Wire ferrules

Complete range for connecting stranded wire with screw-type or spring-loaded terminals

### FEATURES

- Complete range for wire sizes from 0.14 to 50 mm<sup>2</sup>
- Diverse sleeve lengths
- Tool range for all wire sizes
- Sleeve: Electrolytic copper, tin-plated
- Plastic collar: Polypropylene up to +120°C
- All ferrule technical parameters are defined in DIN 46228, part 4

### APPLICATION

- Control cabinets
- Controls
- Functional components

### BENEFITS

- Connects stranded wire perfectly and reliably with screw-type or spring-loaded terminals
- Colour coded plastic collars offer protection against electric shock
- Precision tools are available for gas-tight connections

### Ferrules

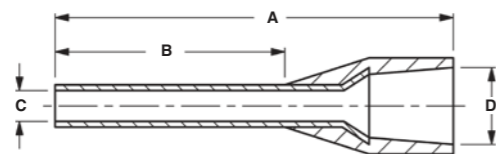

Wire range [mm <sup>2</sup> ]	Max. insulation diameter [mm]	Type	Identification colour	Dimensions [mm]				Insulation stripping length [mm]	Part number
				A	B	C	D		
0.50	2.3	normal	White	14.0	8.0	1.0	2.6	10.0	966067-2
0.75	2.5	normal	Grey-30	14.0	8.0	1.2	2.8	10.0	966067-5
1.00	2.7	normal	Red	14.0	8.0	1.4	3.0	10.0	966067-9
1.50	3.2	normal	Black	14.0	8.0	1.7	3.5	10.0	1-966067-2
2.50	3.9	normal	Blue	14.0	8.0	2.2	4.2	10.0	1-966067-6
4.00	4.5	normal	Grey-30	17.0	10.0	2.8	4.8	12.0	1-966067-9
6.00	6.0	normal	Yellow	20.0	12.0	3.5	6.3	14.0	2-966067-2
10.00	7.3	normal	Red	22.0	12.0	4.5	7.6	15.0	2-966067-4

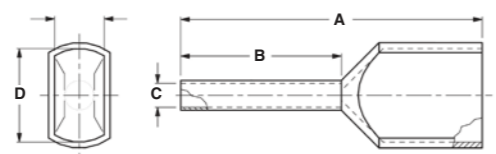

Wire range [mm <sup>2</sup> ]	Max. insulation diameter [mm]	Type	Identification colour	Dimensions [mm]				Insulation stripping length [mm]	Part number
				A	B	C	D		
2 x 0.50	2.1	normal	White	15.0	8.0	4.7	2.5	10.0	966144-1
2 x 0.75	2.2	normal	Grey-30	15.0	8.0	5.0	2.8	10.0	966144-2
2 x 0.75	2.2	long	Grey-30	17.0	10.0	5.0	2.8	12.0	966144-3
2 x 1.00	2.5	normal	Red	15.0	8.0	5.4	3.4	10.0	966144-4
2 x 1.50	3.0	normal	Black	16.0	8.0	6.6	3.6	10.0	966144-6
2 x 2.50	3.6	normal	Blue	18.5	10.0	7.8	4.2	12.0	966144-8
2 x 4.00	4.1	normal	Grey-30	23.0	12.0	8.8	4.9	14.0	1-966144-0

### Tools



Description	Wire range [mm <sup>2</sup> ]	Part number
Square crimping tool	0.08-10	539660-1
	0.75-10	6-1579014-5
Trapezoidal crimping tool	0.14-6.0	734641-2

## SOLISTRAND Terminals and splices

Uninsulated terminals and splices



### FEATURES

- The W-crimp offers exceptional electrical performance and higher tensile strength
- Indents or grooves in the wire barrel offer optimal tightness and maximum electrical contact after crimping
- The conical sleeve enables easy conductor insertion via the funnel entry
- Temperature range: max. +170°C
- UL File No. E13288 listed
- CSA File No. LR 7189 certified

### APPLICATION

- Power transformers
- Power supplies
- Motors
- Switchgear
- Telecommunications
- Service connections
- Control cabinets
- Industrial and building systems
- Machine, equipment and plant engineering
- Transport systems
- For universal use!

### BENEFITS

- SOLISTRAND terminals and splices have been specially designed for solid and stranded wire, irregular shaped conductors and combinations of these.
- The W-crimp in combination with internal serrations or indents establishes connections with optimal electrical characteristics
- SOLISTRAND terminals and splices are made of highly conductive copper



#### 1 Dimples or grooves

The inner surface with dimples or grooves ensures optimal tensile strength and maximum electrical contact

#### 2 Solder joint

Soldering of the crimp barrel prevents the terminal from «opening» during crimping

#### 3 Funnel entry

The conical sleeve enables easy conductor insertion

#### 4 Tab

Gradual transition makes the tab resistant to buckling

Ring tongue terminals

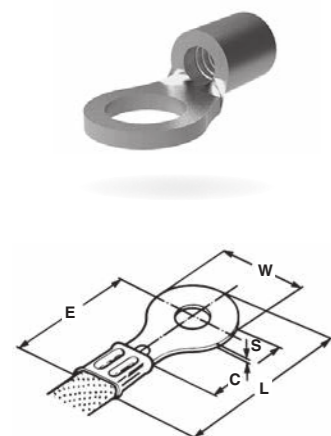

Wire range		Stud size	Stud hole [mm]	Dimensions [mm]					Part number	
[AWG]	[mm²]			S	W	min	L max	E	Bulk pack	Small pack
22-16	0.26-1.65	M2.5	3	0.8	5.5	4.0	11.4	8.6	34104	-
	0.26-1.65	M4	4.3	0.8	7.9	7.1	15.8	11.8	34111	1377172-3
	0.26-1.65	M5	5.5	0.8	7.9	7.1	15.8	11.8	130017	1377172-4
16-14	1.04-2.62	M4	4.3	0.8	8.7	7.1	16.2	11.8	34122	1377172-7
	1.04-2.62	M5	5.5	0.8	8.7	7.1	16.2	11.8	130106	1377172-8
	1.04-2.62	M6	6.6	0.8	11.9	11.1	21.7	15.8	34124	1377172-9
12-10	2.62-6.64	M4	4.3	1.0	9.5	7.7	19.1	14.3	32994	1-1377172-1
	2.62-6.64	M5	5.5	1.0	9.5	7.7	19.1	14.3	130191	1-1377172-2
	2.62-6.64	M6	6.6	1.0	13.5	11.9	25.3	18.3	35772	1-1377172-3
	2.62-6.64	M8	8.2	1.0	13.5	11.8	25.6	18.7	35773	1-1377172-4
8	6.64-10.5	M5	5.5	1.3	11.9	9.1	23.7	17.8	160013	1-1377172-6
	6.64-10.5	M6	6.6	1.3	11.9	9.1	23.7	17.7	33461	1-1377172-7
	6.64-10.5	M8	8.2	1.3	15.1	13.5	29.6	22.1	33462	1-1377172-8
	6.64-10.5	M10	10.5	1.3	15.1	13.5	29.6	22.1	160056	1-1377172-9
6	10.5-16.8	M5	5.5	1.5	11.9	13.5	29.7	23.7	130552	2-1377172-0
	10.5-16.8	M6	6.6	1.5	15.9	13.5	31.6	23.7	33465	2-1377172-1
	10.5-16.8	M8	8.2	1.5	15.9	13.5	31.6	23.7	33466	2-1377172-2
	10.5-16.8	M10	10.5	1.5	15.9	13.5	31.6	23.7	160032	2-1377172-3
4	16.8-26.7	M6	6.6	1.9	12.7	11.1	33.3	25.0	33469	2-1377172-6
	16.8-26.7	M8	8.2	1.9	16.7	13.1	33.3	25.0	33470	2-1377172-7
	16.8-26.7	M10	10.5	1.9	16.7	13.1	33.3	25.0	160075	2-1377172-8
2	26.7-42.4	M8	8.2	1.9	15.8	17.4	38.8	30.9	322870	3-1377172-1
	26.7-42.4	M10	10.5	1.9	22.2	17.4	42.0	30.9	160002	3-1377172-2
	26.7-42.4	M12	12.9	1.9	22.2	17.4	42.0	30.9	35185	3-1377172-3
1/0	42.4-60.6	M8	8.3	1.9	22.2	18.8	49.7	38.5	36916	3-1377172-5
	42.4-60.6	M10	10.5	1.9	22.2	18.8	49.7	38.5	160000	3-1377172-6
	42.4-60.6	M12	13	1.9	22.2	18.8	49.7	38.5	36919	3-1377172-7
2/0	60.0-76.0	M8	8.3	2.1	23.6	19.0	50.8	39.0	36922	3-1377172-9
	60.0-76.0	M10	10.5	2.1	23.6	19.0	50.8	39.0	160001	4-1377172-0
	60.0-76.0	M12	13	2.1	23.6	19.0	50.8	39.0	36925	4-1377172-1
3/0	76.0-96.0	M10	10.5	2.4	27.0	20.7	54.4	41.7	160003	4-1377172-4
	76.0-96.0	M12	13	2.4	27.0	15.9	54.4	41.7	36929	4-1377172-5

Spade tongue terminals

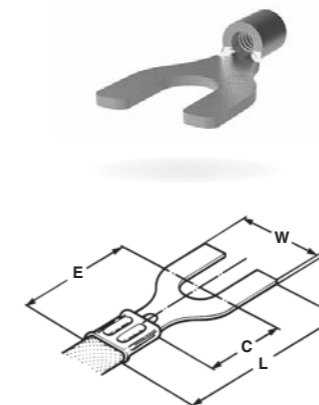

Wire range		Stud size	Stud hole [mm]	Dimensions [mm]					Part number	
[AWG]	[mm²]			S	W	C min	L max	E	Bulk pack	Small pack
22-16	0.26-1.65	M2.6	3.0	0.8	5.5	6.4	14.1	11.3	130524	-
	0.26-1.65	M4.0	4.3	0.8	7.1	6.3	15.0	11.1	130519	-
	0.26-1.65	M4.5	5	0.8	9.5	7.5	17.4	12.3	34118	-
16-14	1.04-2.62	M3.5	3.7	0.8	7.5	5.1	13.5	9.8	322996	-
	1.04-2.62	M4.0	4.3	0.8	7.5	5.1	13.5	9.8	34128	-
	1.04-2.62	M5.0	5.2	0.8	9.8	7.9	17.4	12.5	160127	-
12-10	2.62-6.64	M4.0	4.7	1.0	8.0	12.0	22.8	18.7	130499	-
	2.62-6.64	M6.0	6.3	1.0	13.5	11.2	24.6	17.5	130624	-

Butt splices

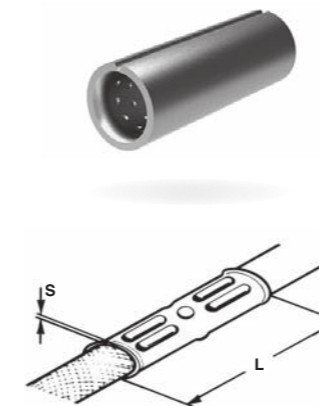

Wire range		Dimensions [mm]		Part number	
[AWG]	[mm²]	L	S	Bulk pack	Small pack
22-16	0.26-1.65	14.3	0.8	31818	7-1377172-1
16-14	1.04-2.62	14.4	0.8	31819	7-1377172-2
12-10	2.62-6.64	14.4	1.0	32151	7-1377172-3
8	6.64-10.5	21	1.2	34321	-
6	10.5-16.8	25.8	1.45	34322	-
4	16.8-26.7	28.6	1.8	34323	-
2	26.7-42.4	32.1	1.8	35189	-
1/0	42.4-60.6	36.1	1.8	36957	-
2/0	60.0-76.0	36.5	2	36958	-
3/0	76.0-96.0	37.3	2.3	36959	-
4/0	98.0-120.0	37.7	2.6	36960	-

Parallel splices

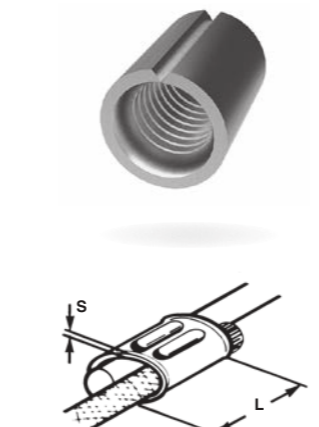

Wire range		Dimensions [mm]		Part number	
[AWG]	[mm²]	L	S	Bulk pack	Small pack
22-16	0.26-1.65	7.6	0.8	34130	2-1856387-0
16-14	1.04-2.62	7.6	0.8	34137	2-1856387-4
12-10	2.62-6.64	8.7	1.0	34138	7-1377172-6
8	6.64-10.5	9.5	1.2	34318	-
6	10.5-16.8	11.1	1.45	34319	-
4	16.8-26.7	13.5	1.8	34320	-
2	26.7-42.4	16.3	1.8	35187	-
1/0	42.4-60.6	18.6	1.8	36946	-
2/0	60.0-76.0	18.6	2	36948	-
3/0	76.0-96.0	19	2.3	36909	-
4/0	98.0-120.0	19.4	2.6	36951	-

## Premium tools



Description	Wire range [AWG]	Part number
Double Action hand tool	22-10	49935
Heavy Head hand tool	8	69355
Hydraulic hand tool with integrated dies	8-2	59975-1

## Hydraulic hand tool



Description	Wire range [AWG]	Part number
U-Die 12 Ton	without die	1490748-1

Wire range (AWG)	Nest for 1490748-1	Indent die for 1490748-1
8	1490413-1	1490414-1
6	1490413-2	1490414-2
4	1490413-3	
2	1490413-4	1490414-3
1/0	1490413-5	
2/0	1490413-6	
3/0	1490413-7	
4/0	1490413-8	

## Commercial tools



Description	Wire range [AWG]	Part number
CERTI-LOK hand tool without die	—	169400
CERTI-LOK die for SOLISTRAND	22-10	169409
SDE PRO-CRIMPER III hand tool without die	—	354940-1
Die for SDE PRO-CRIMPER	22-10	58545-1
BANTAM ROTA-CRIMP hand tool	8-1/0	601075
Standard ROTA-CRIMP hand tool	8-4/0	600850

## Self-laminating cable markers

For low-cost and durable cable marking

## FEATURES

- Cable marking labels
- Self-laminating for higher resistance
- Different sizes
- Write-on or laser printable

## APPLICATION

- Wire and cable marking

## BENEFITS

- Quick and easy installation
- Flexible marking
- Low-cost cable marking solution
- Does not require a specific printer

## Labels for manual marking



Order reference	Label description	Quantity	Label width [mm]	Label height [mm]	max. cable diameter [mm]	Part number
BKM-3823-9	Self-laminating cable markers for manual marking on paper	40	23	38	7	5-1768016-4
BKM-7523-9	Self-laminating cable markers for manual marking on paper	20	23	75	14	5-1768016-7
BKM-7546-9	Self-laminating cable markers for manual marking on paper	10	46	75	14	6-1768016-2
BKM-15023-9	Self-laminating cable markers for manual marking on paper	10	23	150	38	4-1768016-4
BKM-15046-9	Self-laminating cable markers for manual marking on paper	5	46	150	38	4-1768016-7
BKM-23025-9	Self-laminating cable markers for manual marking on paper	6	25	230	63	5-1768016-1
BKM-23050-9	Self-laminating cable markers for manual marking on paper	3	50	230	63	5-1768016-2
TKM50WE-N	Self-laminating cable markers for manual marking of pocket packs	90	25	50	9	7-1768048-7
TKM75-N	Self-laminating cable markers for manual marking of pocket packs	60	25	75	14	8-1768048-1
TKM150-N	Self-laminating cable markers for manual marking of pocket packs	30	25	150	38	6-1768048-2
TKM230-N	Self-laminating cable markers for manual marking of pocket packs	30	25	230	63	6-1768048-6
ZUB-03	Pencil for UV-stable marking	1				535124-000

## Laser printable labels



Order reference	Label description	Quantity	Label width [mm]	Label height [mm]	max. cable diameter [mm]	Part number
CSL-02713P-9	Self-laminating laser printable cable markers	160	12.5	26.7	3	8-1768016-3
CSL-03418P-9	Self-laminating laser printable cable markers	88	18.18	33.9	5	8-1768016-5
CSL-03425P-9	Self-laminating laser printable cable markers	64	25	33.9	5	8-1768016-7
CSL-05525P-9	Self-laminating laser printable cable markers	40	25	55	11	8-1768016-9
CSL-06925P-9	Self-laminating laser printable cable markers	32	25	69	14	9-1768016-1
CSL-06933P-9	Self-laminating laser printable cable markers	24	33.33	69	13	9-1768016-3
CSL-09333P-9	Self-laminating laser printable cable markers	18	33.33	93	19	9-1768016-5
CSL-14033P-9	Self-laminating laser printable cable markers	12	33.33	140	34	9-1768016-7

## Safety labels cable identification

For clearly visible and resistant marking

### FEATURES

- Pre-printed labels
- Self-adhesive film
- Different symbols

### APPLICATION

- Equipment and apparatus marking

### BENEFITS

- Label with protective laminate for durability
- Quick and easy marking

Order reference	Label description	Quantity	Side length, dimensions or diameters [mm]	Part number
ESSW1-025	Self-adhesive safety sign with protective laminate	10	25	7-1768019-9
ESSW1-050	Self-adhesive safety sign with protective laminate	2	50	8-1768019-1
ESSW1-100	Self-adhesive safety sign with protective laminate	2	100	8-1768019-3
ESSW1-200	Self-adhesive safety sign with protective laminate	1	200	8-1768019-8
ESSW30-025	Self-adhesive safety sign with protective laminate	10	25	1768020-5
ESSW30-050	Self-adhesive safety sign with protective laminate	2	50	1768020-6
ESSW30-100	Self-adhesive safety sign with protective laminate	2	100	1768020-7
ESSW80-025	Self-adhesive safety sign with protective laminate	10	25	2-1768020-6
ESSW80-050	Self-adhesive safety sign with protective laminate	2	50	2-1768020-7
ESSW17-052	Self-adhesive safety sign with protective laminate	5	26 x 52	9-1768019-5
ESSW18-074	Self-adhesive safety sign with protective laminate	5	37 x 74	1768020-1
ESSW19-052	Self-adhesive safety sign with protective laminate	5	26 x 52	1768020-2
ESSW19-074	Self-adhesive safety sign with protective laminate	5	37 x 74	1768020-3
ESSW40-052	Self-adhesive safety sign with protective laminate	5	26 x 52	1-1768020-1
ESSW40-074	Self-adhesive safety sign with protective laminate	5	37 x 74	1-1768020-3
ESSW41-052	Self-adhesive safety sign with protective laminate	5	26 x 52	1-1768020-5
ESSW50-105	Self-adhesive safety sign with protective laminate	5	52 x 105	1-1768020-7
ESSW51-105	Self-adhesive safety sign with protective laminate	5	52 x 105	1-1768020-8
ESSW71-105	Self-adhesive safety sign with protective laminate	5	52 x 105	2-1768020-2
ESSW72-074	Self-adhesive safety sign with protective laminate	5	37 x 74	2-1768020-3
ESSW74-052	Self-adhesive safety sign with protective laminate	5	26 x 52	2-1768020-4
ESSW75-037	Self-adhesive safety sign with protective laminate	5	52 x 37	2-1768020-5
LKZ16B3	Self-adhesive wire marker with protective laminate	10	Ø 16	7-1768034-7
LKZ12B4	Self-adhesive wire marker with protective laminate	10	Ø 12.5	6-1768034-2
LKZ12B5	Self-adhesive wire marker with protective laminate	10	Ø 12.5	6-1768034-3
LKZ12B6	Self-adhesive wire marker with protective laminate	10	Ø 12.5	6-1768034-4
LKZ12B7	Self-adhesive wire marker with protective laminate	10	Ø 12.5	6-1768034-5
LKZ12L1	Self-adhesive wire marker with protective laminate	10	Ø 12.5	6-1768034-7
LKZ12L2	Self-adhesive wire marker with protective laminate	10	Ø 12.5	6-1768034-8
LKZ12L3	Self-adhesive wire marker with protective laminate	10	Ø 12.5	6-1768034-9
LKZ12N	Self-adhesive wire marker with protective laminate	10	Ø 12.5	7-1768034-2
LKZ12PE	Self-adhesive wire marker with protective laminate	10	Ø 12.5	7-1768034-3
LKZ12PEN	Self-adhesive wire marker with protective laminate	10	Ø 12.5	7-1768034-4



## Rating labels, marking and equipment labels

For flexible industrial marking

### FEATURES

- Labels for industrial marking
- Write-on or laser printable
- Different colours
- Different sizes

### APPLICATION

- Electronic component marking
- Rating labels for machines and equipment
- Rating and indicating labels for mechanical engineering and construction

### BENEFITS

- Durable marking
- Flexible marking
- Does not require a specific printer

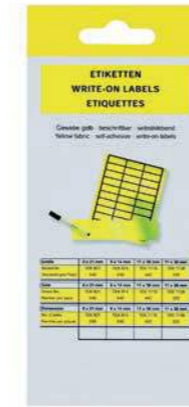

Order reference	Label description	Quantity	Label width [mm]	Label height [mm]	Part number
EB517	Yellow textile write-on labels on sheets	495	17	5	1768017-5
EB615	Yellow textile write-on labels on sheets	444	15	6	1768017-6
EB618	Yellow textile write-on labels on sheets	370	18	6	1768017-7
EB820	Yellow textile write-on labels on sheets	280	20	8	1768017-8
EB1119	Yellow textile write-on labels with black border on sheets	200	19	11	9-1768016-8
EB1128	Yellow textile write-on labels with black border on sheets	120	28	11	9-1768016-9
EB1138	Yellow textile write-on labels with black border on sheets	100	38	11	1768017-1
EB2256	Yellow textile write-on labels with black border on sheets	30	56	22	1768017-2
EB3560	Yellow textile write-on labels with black border on sheets	18	60	35	1768017-3
EB5070	Yellow textile write-on labels on sheets	9	70	50	1768017-4
TEK821-N	Yellow textile write-on labels in pocket pack	640	21	8	5-1768048-3
TEK914-N	Yellow textile write-on labels in pocket pack	840	14	9	5-1768048-6
TEK1119-N	Yellow fabric labels in pocket pack for manual marking with black edge	440	19	11	4-1768048-5
TEK1138-N	Yellow fabric labels in pocket pack for manual marking with black edge	220	38	11	4-1768048-9
ZUB-03	Pencil for UV-stable marking	1	-	-	535124-000
ZUB-01	Felt tip pen	1	-	-	1-1768050-0

## Rating labels, marking and equipment labels

For flexible industrial marking



Order reference	Label description	Quantity	Label width [mm]	Label height [mm]	Part number
LEB2-0615P-4	Yellow polyester laser printable labels	480	15	6	9-1768033-8
LEB2-0615P-8A	Silver polyester laser printable labels	480	15	6	9-1768033-9
LEB2-0615P-9	White polyester laser printable labels	480	15	6	1768034-1
LEB2-0825P-4	Yellow polyester laser printable labels	252	25	8	1768034-8
LEB2-0825P-8A	Silver polyester laser printable labels	252	25	8	1768034-9
LEB2-0825P-9	White polyester laser printable labels	252	25	8	1-1768034-0
LEB2-0916P-4	Yellow polyester laser printable labels	320	16	9	1-1768034-1
LEB2-0916P-8A	Silver polyester laser printable labels	320	16	9	1-1768034-2
LEB2-0916P-9	White polyester laser printable labels	320	16	9	1-1768034-3
LEB2-1325P-4	Yellow polyester laser printable labels	154	25	13	1-1768034-7
LEB2-1325P-8A	Silver polyester laser printable labels	154	25	13	1-1768034-8
LEB2-1325P-9	White polyester laser printable labels	154	25	13	1-1768034-9
LEB-1318P-4	Yellow polyester laser printable labels	220	18	13	7-1768033-0
LEB-1318P-8A	Silver polyester laser printable labels	220	18	13	7-1768033-2
LEB-1318P-9	White polyester laser printable labels	220	18	13	7-1768033-3
LEB-1743P-4	Yellow polyester laser printable labels	52	43	17	8-1768033-9
LEB-1743P-8A	Silver polyester laser printable labels	52	43	17	9-1768033-1
LEB-1743P-9	White polyester laser printable labels	52	43	17	9-1768033-2
LEB-2540P-4	Yellow polyester laser printable labels	44	40	25	2-1768034-5
LEB-2540P-8A	Silver polyester laser printable labels	44	40	25	2-1768034-7
LEB-2540P-9	White polyester laser printable labels	44	40	25	2-1768034-8
LEB-3460P-4	Yellow polyester laser printable labels	21	60	34	3-1768034-0
LEB-3460P-8A	Silver polyester laser printable labels	21	60	34	3-1768034-2
LEB-3460P-9	White polyester laser printable labels	21	60	34	3-1768034-3
LEB-5270P-4	Yellow polyester laser printable labels	10	70	52	3-1768034-6
LEB-5270P-8A	Silver polyester laser printable labels	10	70	52	3-1768034-8
LEB-5270P-9	White polyester laser printable labels	10	70	52	3-1768034-9
LEB-6090P-4	Yellow polyester laser printable labels	8	90	60	4-1768034-6
LEB-6090P-8A	Silver polyester laser printable labels	8	90	60	4-1768034-8
LEB-6090P-9	White polyester laser printable labels	8	90	60	4-1768034-9

## Identification systems

Wide range of pre-marked wire and cable markers

### FEATURES

- Fast and durable cable marking
- Available in different colours and materials
- In different sizes
- With different shrink ratios

### APPLICATION

- Cable markers for wires, cables, conduits and cores

### BENEFITS

- Flexibility
- Compactness
- Marking before or after installation

### STD snap-on wire markers



These snap-on wire markers are ideal for quickly and permanently marking cables, wires, and cores after installation. Markings can be changed quickly and easily. This material offers high stability, dimensional stability, resistance to chemicals and low moisture absorption. The wand is pressed on to the wire or cable to be marked and the marker pushed over the wand with the thumb. The marker opens and grips the cable firmly. Markers are made of an anti-slip material. Resistant to oils, cleaning agents, fuels and alkaline solutions.

External diameter [mm]	Size	Print	Print code	Print	Print code	Print	Print code	Print	Print code
1.00-1.40	01	0	0	B	B	M	M	X	X
1.40-1.80	02	1	1	C	C	N	N	Y	Y
1.90-2.65	03	2	2	D	D	O	O	Z	Z
2.3-3.00	05	3	3	E	E	P	P	/	Slash
2.60-3.50	06	4	4	F	F	Q	Q	Hearth	Earth
3.25-4.50	09	5	5	G	G	R	R	Blank	Blank
4.50-6.00	12	6	6	H	H	S	S	:	Colon
5.80-8.50	15	7	7	I	I	T	T	=	Equal
8.50-11.50	17	8	8	J	J	U	U	.	Dot
11.00-15.50	21	9	9	K	K	V	V	+	Plus
15.00-19.00	24	A	A	L	L	W	W	-	Minus

### Ordering example

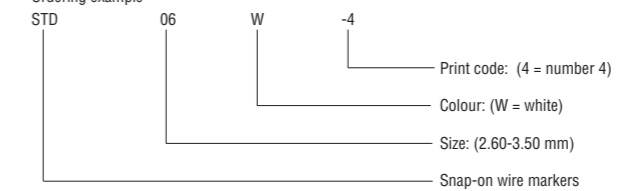

**Z-type cable markers**

Individual snap-on markers for small cables and wires. Designed to accommodate a large number of wire/cable sizes. Easy and low-cost solution for commercial cable marking.

External diameter [mm]	Product code	Pack
1.5-2.0	0580	1000
2.0-3.2	0581	1000
2.5-4.0	0615	1000
2.9-4.7	0616	1000
3.4-5.7	0617	1000
3.8-6.3	0618	1000
4.3-6.9	0620	500
5.5-8.9	0622	500
7.9-12.7	0624	250



Ordering example

0616

1

9

01

Print code

Colour: 9 = white

Pack: (1 = box)

Product code

**K-type cable markers**

For marking wire bundles, cables, pipes and conduits. Oval shaped individual characters on a PVC carrier are attached using cable ties. Elliptical marking profile easily fits on carrier strip. Available in international colour code on reels.

Print	Print code	Print	Print code	Print	Print code	Print	Print code
0	00	C	12	O	24	+	36
1	01	D	13	P	25	-	37
2	02	E	14	Q	26	/	38
3	03	F	15	R	27	~	39
4	04	G	16	S	28	Earth	40
5	05	H	17	T	29	)	41
6	06	I	18	U	30	Blank	42
7	07	J	19	V	31	:	43
8	08	K	20	W	32	.	44
9	09	L	21	X	33	<	45
A	10	M	22	Y	34	>	46
B	11	N	23	Z	35	=	47

Ordering example

1361

1

4

01

Print code

Colour code: 4 = yellow, 9 = white

Pack: (1 = reel)

Product code

**Carrier strip**

Product code	Contents	Quantity
11320000	7	500
11310000	12	500
11300000	18	250
11330000*	12	100

\* these carriers can be used for marking.

**Cable ties and mounting base**

Low-cost bundling and fixing

**FEATURES**

- Material: Polyamide 6.6
- Colour: Natural or black
- Processing temperature: -10°C to +60°C
- The black, weatherproof and UV-resistant type is recommended for outdoor use.
- Flammability: UL 94 V-2

**APPLICATION**

- Bundling and fixing wires, cables, cable harnesses and conduits in numerous industries

**BENEFITS**

- Low-cost bundling and fixing of wires and cables
- Cable tie with conical end for easy insertion into the head.
- The solid plastic construction of the head obviates the need for susceptible metal springs

**Cable tie**

Length	Dimensions [mm]		Max. bundle diameter [mm]	Tensile force (N)	Part number
	Width				
75	2.5		22	80	2-160965-x
100	2.5		22	80	2-160967-x
150	2.5		35	80	2-160968-x
200	2.5		50	80	2-160970-x
150	3.6		35	133	2-160971-x
300	3.6		80	133	2-160972-x
200	4.8		50	222	2-160975-x
300	4.8		80	222	2-160977-x
364	4.8		102	222	2-160978-x
450	4.8		120	222	2-160995-x
200	7.6		50	533	2-160981-x
300	7.6		80	533	2-160982-x
364	7.6		110	533	2-160983-x

x = colour code (Suffix) 1 = natural 2 = black

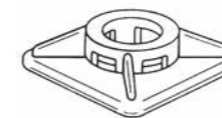
**Self-adhesive mounting base**

Length	Dimensions [mm]		Max. cable tie width [mm]	Part number	
	Width			Natural	Black
19	19		3.6	2-100733-1	2-100733-2
26.5	26.5		4.8	2-100734-1	2-100734-2

**Tool**

Description	Cable tie width [mm]	Part number
Cable tie tool	2.4-4.8	734587-1

## SPIRAP spiral cable wrap

### FEATURES

- Material: Polyethylene
- Available in natural and black
- Bundle range 1.5 mm to 40 mm

### APPLICATION

- Cable harnesses, wires, cables and conduits

### BENEFITS

- Protects against abrasion of wire, cables and conduits
- Attractive - for compact, clearly arranged uniform bundles
- Conforms to military and commercial specifications
- Quickly applied by hand



Colour	Bundle diameter [mm]	Length	Part number
Natural	1.5-7	75	142829-4
Black	1.5-7	75	142839-4
Natural	5-20	30	142830-2
Black	5-20	30	142840-2
Natural	10-40	15	142831-1
Black	10-40	15	142841-1

## SNR relays, packages and accessories

### SNR slim interface relay

### FEATURES

- 1-pole 6 A, 1 Form C (CO), 1 Form A (NO)
- Cadmium-free contacts

### APPLICATION

- Interface technology, slim coupling elements
- Panel boards
- Centralised and decentralised heating controls

### BENEFITS

- Relay only 5 mm wide, with socket 6.2 mm
- Flat version available
- Sensitive coil 170 mW
- Reinforced insulation (protection class II)
- Reinforced coil pins for DIN rail socket
- High function and packing density

### SNR relay



Type	Description	Coil	Contacts	Contact material	Part number
V23092-S1005-A201	Plug-in, vertical version, wash-tight	5 VDC	1 Form C (CO)	AgSn02, gold-plated	1956024-9
V23092-S1005-A301	Plug-in, vertical version, wash-tight	5 VDC	1 Form C (CO)	AgSn02	1-1956024-0
V23092-S1012-A201	Plug-in, vertical version, wash-tight	12 VDC	1 Form C (CO)	AgSn02, gold-plated	1956024-1
V23092-S1012-A301	Plug-in, vertical version, wash-tight	12 VDC	1 Form C (CO)	AgSn02	1956024-2
V23092-S1024-A201	Plug-in, vertical version, wash-tight	24 VDC	1 Form C (CO)	AgSn02, gold-plated	1956024-3
V23092-S1024-A301	Plug-in, vertical version, wash-tight	24 VDC	1 Form C (CO)	AgSn02	1956024-4
V23092-S1048-A201	Plug-in, vertical version, wash-tight	48 VDC	1 Form C (CO)	AgSn02, gold-plated	1956024-5
V23092-S1048-A301	Plug-in, vertical version, wash-tight	48 VDC	1 Form C (CO)	AgSn02	1956024-6
V23092-S1060-A201	Plug-in, vertical version, wash-tight	60 VDC	1 Form C (CO)	AgSn02, gold-plated	1956024-7
V23092-S1060-A301	Plug-in, vertical version, wash-tight	60 VDC	1 Form C (CO)	AgSn02	1956024-8

### SNR relay packages



Type	Socket	Connections	Relay	Contact material	Coil	Part number
ST3P2LC4	ST3FLC4	Screw-type terminals	V23092-S1024-A201	AgSn02, gold-plated	24 VDC	3-1416100-0
ST3P3LB2	ST3FLC4	Screw-type terminals	V23092-S1012-A301	AgSn02	12 VDC	3-1416100-1
ST3P3LC4	ST3FLC4	Screw-type terminals	V23092-S1024-A301	AgSn02	24 VDC	3-1416100-2
ST3P3SM5	ST3FSM5	Screw-type terminals	V23092-S1060-A301	AgSn02	115 VDC/VAC	3-1416100-3
ST3P3TP0	ST3FTP0	Screw-type terminals	V23092-S1060-A301	AgSn02	230 VDC/VAC	3-1416100-4
ST4P2LC4	ST4FLC4	Spring-loaded terminals	V23092-S1024-A201	AgSn02, gold-plated	24 VDC	3-1416100-5
ST4P3LB2	ST4FLC4	Spring-loaded terminals	V23092-S1012-A301	AgSn02	12 VDC	3-1416100-6
ST4P3LC4	ST4FLC4	Spring-loaded terminals	V23092-S1024-A301	AgSn02	24 VDC	3-1416100-7
ST4P3SM5	ST4FSM5	Spring-loaded terminals	V23092-S1060-A301	AgSn02	115 VDC/VAC	3-1416100-8
ST4P3TP0	ST4FTP0	Spring-loaded terminals	V23092-S1060-A301	AgSn02	230 VDC/VAC	3-1416100-9

### SNR relay accessories



Product key	Description	Part number
ST3FLC4	DIN rail socket 24 VDC, for 12/24/48 VDC relays with LED, protection and polarity protection diode, screw-type terminals	2-1416100-0
ST3FTP0	DIN rail socket 230 VAC/VDC with LED and protective circuit, screw-type terminals	2-1416100-2
ST4FLC4	DIN rail socket 24 VDC, for 12/24/48 VDC relays with LED, protection and polarity protection diode, spring-loaded terminals	2-1416100-3
ST4FTP0	DIN rail socket 230 VAC/VDC with LED and protective circuit, spring-loaded terminals	2-1416100-5
ST36040	Partition	2-1416100-6
ST37001	Jumper link, red, 500 mm	2-1416100-7
ST37002	Jumper link, blue, 500 mm	2-1416100-8
ST37003	Jumper link, grey, 500 mm	2-1416100-9
ST37040	Marking, consisting of 100 marking tags	4-1416100-0

## RT relays, packages and accessories

### RT industrial power relays

#### FEATURES

- 1-pole 16 A, 2-pole 8 A
- 1 or 2 Form C (CO) or 1 or 2 Form A (NO) contact
- DC or AC coil
- 5 kV/10 mm coil-contact, reinforced insulation
- Ambient temperature range DC coil 85°C

#### APPLICATION

- Switchgear cabinet controls, mechanical engineering and construction, interface modules

#### BENEFITS

- Standard, compact relays 15.7 mm
- Low coil power loss (only 400 mW)

#### RT relays



Type	Coil	Contacts	Contact material	Part number
RT314012	12 VDC	1 Form C (CO)	AgNi 90/10	9-1393239-5
RT314024	24 VDC	1 Form C (CO)	AgNi 90/10	9-1393239-8
RT314048	48 VDC	1 Form C (CO)	AgNi 90/10	0-1393240-1
RT314060	60 VDC	1 Form C (CO)	AgNi 90/10	0-1393240-2
RT314110	110 VDC	1 Form C (CO)	AgNi 90/10	0-1393240-3
RT314524	24 VAC	1 Form C (CO)	AgNi 90/10	0-1393240-4
RT314615	115 VAC	1 Form C (CO)	AgNi 90/10	0-1393240-6
RT314730	230 VAC	1 Form C (CO)	AgNi 90/10	0-1393240-7
RT315024	24 VDC	1 Form C (CO)	AgNi 90/10, gold-plated	1-1393240-4
RT315730	230 VAC	1 Form C (CO)	AgNi 90/10, gold-plated	1-1419108-1
RT334012	12 VDC	1 Form C (CO)	AgNi 90/10	4-1393240-5
RT334024	24 VDC	1 Form C (CO)	AgNi 90/10	4-1393240-8
RT334730	230 VAC	1 Form C (CO)	AgNi 90/10	5-1393240-6
RT424012	12 VDC	2 Form C (CO)	AgNi 90/10	6-1393243-3
RT424024	24 VDC	2 Form C (CO)	AgNi 90/10	6-1393243-8
RT424048	48 VDC	2 Form C (CO)	AgNi 90/10	7-1393243-0
RT424060	60 VDC	2 Form C (CO)	AgNi 90/10	7-1393243-3
RT424110	110 VDC	2 Form C (CO)	AgNi 90/10	7-1393243-5
RT424524	24 VAC	2 Form C (CO)	AgNi 90/10	7-1393243-6
RT424615	115 VAC	2 Form C (CO)	AgNi 90/10	7-1393243-8
RT424730	230 VAC	2 Form C (CO)	AgNi 90/10	7-1393243-9
RT425024	24 VDC	2 Form C (CO)	AgNi 90/10, gold-plated	8-1393243-5
RT425730	230 VAC	2 Form C (CO)	AgNi 90/10, gold-plated	9-1393243-3

#### RT relay package



Type	Coil	Contacts	Contact material	LED	Part number
RT3S4LC4	24VDC	1 Form C (CO)	AgNi 90/10	x	4-1415073-1
RT3S4R24	24VAC	1 Form C (CO)	AgNi 90/10	x	5-1415073-1
RT3S4T30	230VAC	1 Form C (CO)	AgNi 90/10	x	6-1415073-1
RT3S5LC4	24VDC	1 Form C (CO)	AgNi 90/10, gold-plated	x	7-1415073-1
RT3S5R24	24VAC	1 Form C (CO)	AgNi 90/10, gold-plated	x	8-1415073-1
RT3S5T30	230VAC	1 Form C (CO)	AgNi 90/10, gold-plated	x	9-1415073-1
RT4S4LC4	24VDC	2 Form C (CO)	AgNi 90/10	x	1-1415073-1
RT4S4R24	24VAC	2 Form C (CO)	AgNi 90/10	x	2-1415073-1
RT4S4T30	230VAC	2 Form C (CO)	AgNi 90/10	x	3-1415073-1
RT4S5LC4	24VDC	2 Form C (CO)	AgNi 90/10, gold-plated	x	1415074-1
RT4S5R24	24VAC	2 Form C (CO)	AgNi 90/10, gold-plated	x	1-1415074-1
RT4S5T30	230VAC	2 Form C (CO)	AgNi 90/10, gold-plated	x	2-1415074-1

#### RT relay accessories



Type	Description	Part number
RT78724	Socket with screw-type terminals, pinning 3.5 mm for DIN rail mounting, logical terminal arrangement	8-1415035-1
RT78726	Socket with screw-type terminals, pinning 5 mm for DIN rail mounting, logical terminal arrangement	6-1415035-1
RT78725	Socket with screw-type terminals, pinning 5 mm for DIN rail mounting, conventional terminal arrangement	1860306-1
RT7872P	Premium socket, local terminal arrangement, socket with screwless terminals, pinning 5 mm for DIN rail mounting	1860200-1
RT17017	Plastic retaining clip, relay height 15.7 mm	2022103-1
RT17040	Marking tag	2-1415038-1
RT170R8	Jumper link, max. load current 12 A, for connection of up to 8 RT sockets	1860517-8
RT170P1	Jumper link, max. load current 12 A for RT premium sockets	1860211-1
PTMT00A0	Protection diode (standard, A1+, A2-)	9-1415036-1
PTMT00L0	Protection diode (A1-, A2+)	0-1415037-1
PTMU0524	RC network 6 to 60 VAC	1-1415037-1
PTMU0730	RC network 110 to 230 VAC	2-1415037-1
PTMV0524	Varistor 24 VAC	3-1415037-1
PTMV0730	Varistor 230 VAC	4-1415037-1
PTML0024	Red LED 6 to 24 VDC with protection diode (Std, A1+, A2-)	5-1415036-1
PTML0524	Red LED 6 to 24 VDC/VAC	6-1415036-1
PTML0730	Red LED 110 to 230 VAC	7-1415036-1
PTML1024	Red LED 6 to 24 VDC with protection diode (A1-, A2+)	8-1415036-1
PTMG0024	Green LED 6 to 24 VDC with protection diode (Std, A1+, A2-)	2-1415036-1
PTMG0524	Green LED 6 to 24 VDC/VAC	3-1415036-1
PTMG0730	Green LED 110 to 230 VAC	4-1415036-1





## XT relays, packages and accessories

XT interface plug-in relays

### FEATURES

- 1-pole 16 A, 2-pole 8 A, 1 Form C (1 CO) contact or 2 Form C (2 CO) contacts
- DC or AC coil
- Reinforced insulation, protection class II (VDE 0700)
- 4 kV/8 mm coil contact assembly

### APPLICATION

- Switchgear cabinet controls, mechanical engineering and construction

### BENEFITS

- Manual test button, optionally lockable
- Version with mechanical and/or electrical indicator available
- Suitable for TE standard RT sockets
- Recyclable packaging

### XT relays



Type	Description	Coil	Contacts	Current rating	Contact material	Part number
XT374LC4	DC coil	24 VDC	1 Form C (CO)	16 A	AgNi90/10	1887112-1
XT374R24	AC coil	24 VAC	1 Form C (CO)	16 A	AgNi90/10	1887113-3
XT374T30	AC coil	230 VAC	1 Form C (CO)	16 A	AgNi90/10	1887113-1
XT484LC4	DC coil	24 VDC	2 Form C (CO)	8 A	AgNi90/10	1887212-1
XT484R24	AC coil	24 VAC	2 Form C (CO)	8 A	AgNi90/10	1887213-3
XT484T30	AC coil	230 VAC	2 Form C (CO)	8 A	AgNi90/10	1887213-1

### XT relay package



Type	Coil	Socket	Retaining clip	Marking tag	Relay	Part number
XT3S4LC4	24 VDC	RT78726	XT17017	RT17040	XT374LC4	4-1415540-1
XT3S4R24	24 VAC	RT78726	XT17017	RT17040	XT374R24	4-1415540-2
XT3S4T30	230 VAC	RT78726	XT17017	RT17040	XT374T30	4-1415540-4
XT4S4LC4	24 VDC	RT78726	XT17017	RT17040	XT484LC4	4-1415540-5
XT4S4R24	24 VAC	RT78726	XT17017	RT17040	XT484R24	4-1415540-6
XT4S4T30	230 VAC	RT78726	XT17017	RT17040	XT484T30	4-1415540-8

### XT relay accessories



Type	Description	Part number
RT78726	Socket with screw-type terminals, pinning 5 mm, for DIN rail mounting, logical terminal arrangement	6-1415035-1
RT78725	Socket with screw-type terminals, pinning 5 mm for DIN rail mounting, conventional terminal arrangement	1860306-1
RT7872P	Premium socket, logical terminal arrangement, socket with screwless terminals, pinning 5 mm for DIN rail mounting	1860200-1
XT17017	Plastic retaining clip, 25.5mm relay height	2022104-1
RT17040	Marking tag	2-1415038-1
RT170R8	Jumper link, max. load current 12 A, for connection of up to 8 RT sockets	1860517-8
RT170P1	Jumper link, max. load current 12A for RT Premium sockets	1860211-1
PTMT00A0	Protection diode (standard, A1+, A2-)	9-1415036-1
PTMT00L0	Protection diode (A1-, A2+)	0-1415037-1
PTMU0524	RC network 6 to 60 VAC	1-1415037-1
PTMU0730	RC network 110 to 230 VAC	2-1415037-1
PTMV0524	Varistor 24 VAC	3-1415037-1
PTMV0730	Varistor 230 VAC	4-1415037-1
PTML0024	Red LED 6 to 24 VDC with protection diode (Std, A1+, A2-)	5-1415036-1
PTML0524	Red LED 6 to 24 VDC/VAC	6-1415036-1
PTML0730	Red LED 110 to 230 VAC	7-1415036-1
PTML1024	Red LED 6 to 24 VDC with protection diode (A1-, A2+)	8-1415036-1
PTMG0024	Green LED 6 to 24 VDC with protection diode (Std, A1+, A2-)	2-1415036-1
PTMG0524	Green LED 6 to 24 VDC/VAC	3-1415036-1
PTMG0730	Green LED 110 to 230 VAC	4-1415036-1

## PT miniature relays, packages and accessories

PT industrial relays

### FEATURES

- 2, 3 or 4 Form C (CO) contacts
- 2-pole 12 A, 3-pole 10 A or 4-pole 6 A
- DC or AC coil
- Mechanical indicator, optional electrical indicator and free-wheeling diode
- Fingerproof test tab, optionally lockable

### APPLICATION

- Universal use in control and automation

### BENEFITS

- Relay height only 29 mm
- Switching capacity up to 3000 VA
- Low coil power loss (750 mW/1000 mVA)

### PT relay



Type	Coil	Contacts	Contact material	LED	Part number
PT270024	24 VDC	2 Form C (CO)	AgNi 90/10		4-1419111-2
PT270524	24 VAC	2 Form C (CO)	AgNi 90/10		4-1419111-8
PT270730	230 VAC	2 Form C (CO)	AgNi 90/10		5-1419111-1
PT270L24	24 VDC	2 Form C (CO)	AgNi 90/10	x	9-1415001-1
PT270R24	24 VAC	2 Form C (CO)	AgNi 90/10	x	0-1415002-1
PT270T30	230 VAC	2 Form C (CO)	AgNi 90/10	x	3-1415002-1
PT370024	24 VDC	3 Form C (CO)	AgNi 90/10		6-1419111-1
PT370524	24 VAC	3 Form C (CO)	AgNi 90/10		6-1419111-6
PT370730	230 VAC	3 Form C (CO)	AgNi 90/10		6-1419111-9
PT370L24	24 VDC	3 Form C (CO)	AgNi 90/10	x	5-1415002-1
PT370R24	24 VAC	3 Form C (CO)	AgNi 90/10	x	7-1415002-1
PT370T30	230 VAC	3 Form C (CO)	AgNi 90/10	x	9-1415002-1
PT570012	12 VDC	4 Form C (CO)	AgNi 90/10		8-1419111-0
PT570024	24 VDC	4 Form C (CO)	AgNi 90/10		1-1393154-2
PT570048	48 VDC	4 Form C (CO)	AgNi 90/10		8-1419111-1
PT570060	60 VDC	4 Form C (CO)	AgNi 90/10		8-1419111-2
PT570110	110 VDC	4 Form C (CO)	AgNi 90/10		8-1419111-3
PT570524	24 VAC	4 Form C (CO)	AgNi 90/10		8-1419111-7
PT570615	115 VAC	4 Form C (CO)	AgNi 90/10		9-1419111-0
PT570730	230 VAC	4 Form C (CO)	AgNi 90/10		9-1419111-1
PT570L24	24 VDC	4 Form C (CO)	AgNi 90/10	x	6-1415001-1
PT570R24	24 VAC	4 Form C (CO)	AgNi 90/10	x	7-1415001-1
PT570S15	115 VAC	4 Form C (CO)	AgNi 90/10	x	7-1415003-1
PT570T30	230 VAC	4 Form C (CO)	AgNi 90/10	x	8-1415001-1
PT580024	24 VDC	4 Form C (CO)	AgNi 90/10, gold-plated		1-1393154-7
PT580524	24 VAC	4 Form C (CO)	AgNi 90/10, gold-plated		2-1393154-1
PT580730	230 VAC	4 Form C (CO)	AgNi 90/10, gold-plated		2-1393154-2

Further types available on request. All types with test button.

## PT relay package



Type	Coil	Contacts	Contact material	Part number
PT2S7LB2	12 VDC	2 Form C (CO)	AgNi 90/10	7-1415074-1
PT2S7LC4	24 VDC	2 Form C (CO)	AgNi 90/10	8-1415074-1
PT2S7RC4	24 VAC	2 Form C (CO)	AgNi 90/10	5-1415074-1
PT2S7TD0	230 VAC	2 Form C (CO)	AgNi 90/10	6-1415074-1
PT3S7LB2	12 VDC	3 Form C (CO)	AgNi 90/10	1-1415075-1
PT3S7LC4	24 VDC	3 Form C (CO)	AgNi 90/10	2-1415075-1
PT3S7RC4	24 VAC	3 Form C (CO)	AgNi 90/10	9-1415074-1
PT3S7TD0	230 VAC	3 Form C (CO)	AgNi 90/10	0-1415075-1
PT5S7LB2	12 VDC	4 Form C (CO)	AgNi 90/10	9-1415075-1
PT5S7LC4	24 VDC	4 Form C (CO)	AgNi 90/10	0-1415076-1
PT5S7RC4	24 VAC	4 Form C (CO)	AgNi 90/10	7-1415075-1
PT5S7TD0	230 VAC	4 Form C (CO)	AgNi 90/10	8-1415075-1
PT5S8LB2	12 VDC	4 Form C (CO)	AgNi 90/10, gold-plated	5-1415075-1
PT5S8LC4	24 VDC	4 Form C (CO)	AgNi 90/10, gold-plated	6-1415075-1
PT5S8RC4	24 VAC	4 Form C (CO)	AgNi 90/10, gold-plated	3-1415075-1
PT5S8TD0	230 VAC	4 Form C (CO)	AgNi 90/10, gold-plated	4-1415075-1

Further types available on request. All types with test button.

## PT relay accessories



Type	Description	Part number
PT78720	DIN rail socket with screw-type terminals, 2-pole	6-1415034-1
PT78730	DIN rail socket with screw-type terminals, 3-pole	9-1415071-1
PT78740	DIN rail socket with screw-type terminals, 4-pole	4-1415033-1
PT78741	DIN rail socket with screw-type terminals, 4-pole, package with protection diode module	5-1415034-1
PT78722	Socket with screw-type terminals, for DIN rail mounting, logical terminal arrangement (In/Out), 2-pole	1415526-1
PT78742	Socket with screw-type terminals, for DIN rail mounting, logical terminal arrangement (In/Out), 4-pole	1-1415526-1
PT7872P	Premium socket, logical terminal arrangement, 2-pole with screwless terminals	1860100-1
PT7874P	Premium socket, logical terminal arrangement, 4-pole with screwless terminals	1860000-1
PT17021	Plastic retaining clip, relay height 29 mm for PT78722/42/2P/4P	2-1415526-1
PT 17 016	Plastic retaining clip PT, relay height 29 mm for PT78720/30/40	5-1415037-1
PT 17 024	Plastic retaining clip PT, with ejector function, relay height 29 mm for PT78720/30/40	1816124-1
PT28800	Metal retaining clip, relay height 29 mm	5-1419111-9
PT17040	Marking tag	6-1415037-1
PT170R6	Jumper link, max. load current 12 A for connection of up to 6 PT screw sockets	1860517-5
PT170P1	Jumper link, max. 12 A load current for PT Premium sockets	1860214-1
PTMT00A0	Protection diode (standard, A1+, A2-)	9-1415036-1
PTMT00L0	Protection diode (A1-, A2+)	0-1415037-1
PTMU0524	RC network 6 to 60 VAC	1-1415037-1
PTMU0730	RC network 110 to 230 VAC	2-1415037-1
PTMV0524	Varistor 24 VAC	3-1415037-1
PTMV0730	Varistor 230 VAC	4-1415037-1
PTML0024	Red LED 6 to 24 VDC with protection diode (Std, A1+, A2-)	5-1415036-1
PTML0524	Red LED 6 to 24 VDC/VAC	6-1415036-1
PTML0730	Red LED 110 to 230 VAC	7-1415036-1
PTML1024	Red LED 6 to 24 VDC with protection diode (A1-, A2+)	8-1415036-1
PTMG0024	Green LED 6 to 24 VDC with protection diode (Std, A1+, A2-)	2-1415036-1
PTMG0524	Green LED 6 to 24 VDC/VAC	3-1415036-1
PTMG0730	Green LED 110 to 230 AC	4-1415036-1

## RM relays and accessories

## RM power relays

## FEATURES

- Power relay RM 2/3/7
- Power relay RM 5/6 3mm 2 and 3-pole 10/16 A, 2 Form A (2 NO) or 3 Form A (3 NO) contacts  
3 mm contact gap
- Power relay RM 8 2-pole 25 A 2 Form C (2 CO) contacts
- Power relay RM C/D 1-pole 30/32 A 1 Form X, bridge contact, NO or 1 Form Z, bridge contact, NO + NC  
Switching capacity up to 7500 VA

## APPLICATION

- Elevator controls, power supplies
- Pump controls
- Cleaning machines, heating/cooling equipment
- Battery chargers, heating controls

## BENEFITS

- Mechanical indicator
- Test button
- Plug-in or PCB terminals, flange mount, DIN rail mounting
- DC or AC coil for all versions

## Power relay RM 2/3/7



Type	Coil	Contacts	Test button	LED	Protection diode	Housing	Part number
RM202024	24 VDC	2 Form C (CO)				Plain cover, 4.8 mm quick connect terminals	8-1393149-2
RM202524	24 VAC	2 Form C (CO)				Plain cover, 4.8 mm quick connect terminals	1-1393146-9
RM202615	115 VAC	2 Form C (CO)				Plain cover, 4.8 mm quick connect terminals	2-1393146-0
RM202730	230 VAC	2 Form C (CO)				Plain cover, 4.8 mm quick connect terminals	1-1393148-4
RM208730	230 VAC	2 Form C (CO)				Cover with DIN snap-on attachment, horizontal, 6.3 mm tab	8-1393149-6
RM232024	24 VDC	2 Form C (CO)	x			Plain cover, 4.8 mm quick connect terminals	3-1393146-8
RM232524	24 VAC	2 Form C (CO)	x			Plain cover, 4.8 mm quick connect terminals	3-1393146-9
RM232730	230 VAC	2 Form C (CO)	x			Plain cover, 4.8 mm quick connect terminals	3-1393107-4
RM239730	230 VAC	2 Form C (CO)	x			Cover with DIN snap-on attachment, horizontal, 6.3 mm tab	4-1393148-7
RM302024	24 VDC	3 Form C (CO)				Plain cover, 4.8 mm quick connect terminals	8-1393149-9
RM302524	24 VAC	3 Form C (CO)				Plain cover, 4.8 mm quick connect terminals	5-1393146-3
RM302615	115 VAC	3 Form C (CO)				Plain cover, 4.8 mm quick connect terminals	5-1393146-4
RM302730	230 VAC	3 Form C (CO)				Plain cover, 4.8 mm quick connect terminals	5-1419150-3
RM302LC4	24 VDC	3 Form C (CO)		x	x	Plain cover, 4.8 mm quick connect terminals	3-1393107-8
RM332024	24 VDC	3 Form C (CO)	x			Plain cover, 4.8 mm quick connect terminals	9-1393149-2
RM332524	24 VAC	3 Form C (CO)	x			Plain cover, 4.8 mm quick connect terminals	9-1393149-3
RM332730	230 VAC	3 Form C (CO)	x			Plain cover, 4.8 mm quick connect terminals	9-1393149-4
RM338730	230 VAC	3 Form C (CO)	x			Cover with DIN snap-on attachment, horizontal, 6.3 mm tab	7-1393148-7
RM339730	230 VAC	3 Form C (CO)	x			Cover with DIN snap-on attachment, horizontal, 6.3 mm tab	6-1393107-2
RM702024	24 VDC	3 Form C (CO)				Plain cover, 4.8 mm quick connect terminals	8-1393146-5
RM7020C4	24 VDC	3 Form C (CO)			x	Plain cover, 4.8 mm quick connect terminals	8-1393146-4
RM702524	24 VAC	3 Form C (CO)				Plain cover, 4.8 mm quick connect terminals	1393844-9
RM702615	115 VAC	3 Form C (CO)				Plain cover, 4.8 mm quick connect terminals	1-1393844-0
RM702730	230 VAC	3 Form C (CO)				Plain cover, 4.8 mm quick connect terminals	1-1393844-1
RM702L24	24 VDC	3 Form C (CO)		x		Plain cover, 4.8 mm quick connect terminals	8-1393146-3
RM708024	24 VDC	3 Form C (CO)				Cover with DIN snap-on attachment, horizontal, 6.3 mm tab	1393147-4
RM7080C4	24 VDC	3 Form C (CO)			x	Cover with DIN snap-on attachment, horizontal, 6.3 mm tab	1393147-3

Further types available on request.

## Power relay RM 2/3/7



Type	Coil	Contacts	Test button	LED	Protection diode	Housing	Part number
RM708730	230 VAC	3 Form C (CO)				Cover with DIN snap-on attachment, horizontal, 6.3 mm tab	1-1419136-0
RM709024	24 VDC	3 Form C (CO)				Cover with DIN snap-on attachment, horizontal, 6.3 mm tab	2-1393149-2
RM709730	230 VAC	3 Form C (CO)				Cover with DIN snap-on attachment, horizontal, 6.3 mm tab	1393147-5
RM732024	24 VDC	3 Form C (CO)	x			Plain cover, 4.8 mm quick connect terminals	1-1393844-7
RM7320C4	24 VDC	3 Form C (CO)	x		x	Plain cover, 4.8 mm quick connect terminals	1393147-8
RM732524	24 VAC	3 Form C (CO)	x			Plain cover, 4.8 mm quick connect terminals	1-1393147-0
RM732615	115 VAC	3 Form C (CO)	x			Plain cover, 4.8 mm quick connect terminals	1-1393147-1
RM732730	230 VAC	3 Form C (CO)	x			Plain cover, 4.8 mm quick connect terminals	1-1393844-8
RM732LC4	24 VDC	3 Form C (CO)	x	x	x	Plain cover, 4.8 mm quick connect terminals	1393147-6
RM738024	24 VDC	3 Form C (CO)	x			Cover with DIN snap-on attachment, horizontal, 6.3 mm tab	2-1393844-0
RM7380C4	24 VDC	3 Form C (CO)	x		x	Cover with DIN snap-on attachment, horizontal, 6.3 mm tab	2-1393844-1
RM738730	230 VAC	3 Form C (CO)	x			Cover with DIN snap-on attachment, horizontal, 6.3 mm tab	2-1393147-2
RM739024	24 VDC	3 Form C (CO)	x			Cover with DIN snap-on attachment, horizontal, 6.3 mm tab	4-1393149-5
RM739730	230 VAC	3 Form C (CO)	x			Cover with DIN snap-on attachment, horizontal, 6.3 mm tab	2-1393844-2

Further types available on request.

## Power relay RM 5/6



Type	Coil	Contacts	Test button	LED	Protection diode	Housing	Part number
RM502024	24 VDC	2 Form C (CO)				Plain cover, 4.8 mm quick connect terminals	6-1393146-1
RM502524	24 VAC	2 Form C (CO)				Plain cover, 4.8 mm quick connect terminals	6-1393146-2
RM502615	115 VAC	2 Form C (CO)				Plain cover, 4.8 mm quick connect terminals	6-1393146-3
RM509LC4	24 VDC	2 Form C (CO)		x	x	Cover with DIN snap-on attachment, horizontal, 6.3 mm tab	1393844-2
RM532LC4	24 VDC	2 Form C (CO)	x	x	x	Plain cover, 4.8 mm quick connect terminals	7-1393146-1
RM5390C4	24 VDC	2 Form C (CO)			x	Cover with DIN snap-on attachment, horizontal, 6.3 mm tab	7-1393146-4
RM602024	24 VDC	3 Form C (CO)				Plain cover, 4.8 mm quick connect terminals	1393844-4
RM602615	115 VAC	3 Form C (CO)				Plain cover, 4.8 mm quick connect terminals	9-1393148-7
RM632024	24 VDC	3 Form C (CO)	x			Plain cover, 4.8 mm quick connect terminals	8-1393146-0
RM632730	230 VAC	3 Form C (CO)	x			Plain cover, 4.8 mm quick connect terminals	1393149-7
RM632LC4	24 VDC	3 Form C (CO)	x	x	x	Plain cover, 4.8 mm quick connect terminals	1393149-2

Further types available on request.

## Power relay RM 8



Type	Coil	Contacts	Test button	Protection diode	Housing	Part number
RM808024	24 VDC	2 Form C (CO)			Cover with DIN snap-on attachment, horizontal, 6.3 mm tab	2-1393844-9
RM808524	24 VAC	2 Form C (CO)			Cover with DIN snap-on attachment, horizontal, 6.3 mm tab	3-1393147-7
RM808730	230 VAC	2 Form C (CO)			Cover with DIN snap-on attachment, horizontal, 6.3 mm tab	5-1393149-7
RM809024	24 VDC	2 Form C (CO)			Cover with DIN snap-on attachment, horizontal, 6.3 mm tab	5-1393149-8
RM809615	115 VAC	2 Form C (CO)			Cover with DIN snap-on attachment, horizontal, 6.3 mm tab	3-1393147-8
RM809730	230 VAC	2 Form C (CO)			Cover with DIN snap-on attachment, horizontal, 6.3 mm tab	3-1393147-9
RM838024	24 VDC	2 Form C (CO)	x		Cover with DIN snap-on attachment, horizontal, 6.3 mm tab	4-1393147-8
RM838524	24 VAC	2 Form C (CO)	x		Cover with DIN snap-on attachment, horizontal, 6.3 mm tab	5-1393147-0
RM838730	230 VAC	2 Form C (CO)	x		Cover with DIN snap-on attachment, horizontal, 6.3 mm tab	5-1393147-1
RM839024	24 VDC	2 Form C (CO)	x		Cover with DIN snap-on attachment, horizontal, 6.3 mm tab	5-1393147-4
RM8390C4	24 VDC	2 Form C (CO)	x	x	Cover with DIN snap-on attachment, horizontal, 6.3 mm tab	5-1393147-2
RM839524	24 VAC	2 Form C (CO)	x		Cover with DIN snap-on attachment, horizontal, 6.3 mm tab	5-1393147-5
RM839730	230 VAC	2 Form C (CO)	x		Cover with DIN snap-on attachment, horizontal, 6.3 mm tab	5-1393147-6

Further types available on request.

## Power relay RM C/D



Type	Coil	Contacts	Test button	Part number
RMC05024	24 VDC	Form Z (1 NO + 1 NC) <sup>1)</sup>		4-1393844-5
RMC05524	24 VAC	Form Z (1 NO + 1 NC) <sup>1)</sup>		1393146-5
RMC05615	115 VAC	Form Z (1 NO + 1 NC) <sup>1)</sup>		8-1393147-7
RMC05730	230 VAC	Form Z (1 NO + 1 NC) <sup>1)</sup>		1393146-6
RMC35024	24 VDC	Form Z (1 NO + 1 NC) <sup>1)</sup>	x	1393146-7
RMD05024	24 VDC	1 Form X (NO) <sup>2)</sup>		1393146-9
RMD05524	24 VAC	1 Form X (NO) <sup>2)</sup>		1-1393146-1
RMD05615	115 VAC	1 Form X (NO) <sup>2)</sup>		1415009-1
RMD05730	230 VAC	1 Form X (NO) <sup>2)</sup>		4-1393844-7
RMD35730	230 VAC	1 Form X (NO) <sup>2)</sup>	x	1393097-5

<sup>1)</sup> NC and NO bridge contact <sup>2)</sup> NO bridge contact

## RM relay accessories



Type	Description	Part number
RM78700	Socket with push-lock terminals	1419118-6
RM78701	Socket with solder terminals	4-1393149-9
RM78702	Socket with PCB terminals	2-1393844-3
RM78705	Socket with screw-type terminals	2-1393844-5
RM28802	Metal retaining clip for RM	1419118-5

## MT relay and accessories

### MT multimode relay

#### FEATURES

- 2 Form C (CO) or 3 Form C (CO) contacts
- 2/3-pole 10A
- DC or AC coil

#### APPLICATION

- Mechanical engineering, plant control

#### BENEFITS

- Mechanical indicator as standard
- Electrical indicator optional
- Test button system with fingerproof actuation from the front and integrated, lockable test button

#### MT relays



Type	Coil	Contacts	Contact material	LED	Protection diode	Part number
MT221024	24 VDC	2 Form C (CO)	AgNi 90/10			5-1393090-0
MT223024	24 VDC	2 Form C (CO)	AgNi 90/10	x		5-1393090-7
MT2230C4	24 VDC	2 Form C (CO)	AgNi 90/10	x	x	5-1393090-5
MT226024	24 VDC	2 Form C (CO)	AgNi 90/10			6-1393090-4
MT226115	115 VAC	2 Form C (CO)	AgNi 90/10			6-1393090-7
MT226230	230 VAC	2 Form C (CO)	AgNi 90/10			6-1393090-8
MT228024	24 VDC	2 Form C (CO)	AgNi 90/10	x		6-1393090-9
MT228115	115 VAC	2 Form C (CO)	AgNi 90/10	x		7-1393090-0
MT228230	230 VAC	2 Form C (CO)	AgNi 90/10	x		7-1393090-1
MT231024	24 VDC	2 Form C (CO)	AgNi 90/10, gold-plated			7-1393090-2
MT236230	230 VAC	2 Form C (CO)	AgNi 90/10, gold-plated	x		7-1393090-5
MT321024	24 VDC	3 Form C (CO)	AgNi 90/10			7-1393091-0
MT3210C4	24 VDC	3 Form C (CO)	AgNi 90/10		x	6-1393091-5
MT323024	24 VDC	3 Form C (CO)	AgNi 90/10	x		8-1393091-4
MT3230C4	24 VDC	3 Form C (CO)	AgNi 90/10	x	x	7-1393091-9
MT326024	24 VDC	3 Form C (CO)	AgNi 90/10			9-1393091-7
MT326115	115 VAC	3 Form C (CO)	AgNi 90/10			1393092-1
MT326230	230 VAC	3 Form C (CO)	AgNi 90/10			1393092-2
MT328024	24 VDC	3 Form C (CO)	AgNi 90/10	x		1393092-4
MT328115	115 VAC	3 Form C (CO)	AgNi 90/10	x		1393092-7
MT328230	230 VAC	3 Form C (CO)	AgNi 90/10	x		1393092-8
MT331024	24 VDC	3 Form C (CO)	AgNi 90/10, gold-plated			1-1393092-1
MT333024	24 VDC	3 Form C (CO)	AgNi 90/10, gold-plated	x		1-1393092-8
MT3330C4	24 VDC	3 Form C (CO)	AgNi 90/10, gold-plated	x	x	1-1393092-6
MT336115	115 VAC	3 Form C (CO)	AgNi 90/10, gold-plated			2-1393092-5
MT336230	230 VAC	3 Form C (CO)	AgNi 90/10, gold-plated			2-1393092-6
MT338024	24 VDC	3 Form C (CO)	AgNi 90/10, gold-plated	x		2-1393092-7
MT338230	230 VAC	3 Form C (CO)	AgNi 90/10, gold-plated	x		2-1393092-8

Further types available on request. All types with test button.

#### MT relay accessories



Type	Description	Part number
MT78750	MT3 socket with screw-type terminals, 11 pins for DIN rail mounting	1415035-1
MT78755	MT2 socket with screw-type terminals, 8 pins for DIN rail mounting	3-1415035-1
MT78760	MT3 socket with screw-type terminals, 11 pins for DIN rail mounting	8-1415034-1
MT28800	MT metal retaining clip	8-1393163-0
MT78740	DIN rail socket with screw-type terminals, 11 pins with module bay	8-1393163-3
MT78745	DIN rail socket with screw-type terminals, 8 pins with module bay	8-1393163-4
MT28800	MT metal retaining clip	8-1393163-0
MTMT00A0	Protection diode 1N4007 (A1+, A2-)	7-1393163-6
MTMU0730	RC network 110 to 230VAC	7-1393163-8
MTML0024	Red LED 24VAC/VDC	7-1393163-4
MTM20W00	Delay ON module	7-1393163-9
MTMF0W00	Multifunction timer module	7-1393163-3



## 3 mm connector system

Compact free hanging or panel mount connector system



### FEATURES

- Voltage rating/Current rating: 250 V/5 A with AWG20
- Temperature range: -40°C to +105°C
- Flammability classes UL 94 V-0
- Housing material: Nylon, black
- Crimp contacts are available in strips for mechanical processing or loose for processing with a hand tool
- VDE, UL, CSA approved

### APPLICATION

- Measurement
- Industrial controls
- Household appliances
- Security systems

### BENEFITS

- ♦ Compact pin and socket housing 3.0 mm centreline
- ♦ Suitable for free hanging or panel mount
- ♦ Contacts fully enclosed in the housing
- ♦ Available positions: 2-12 single row, 12-24 double row

### Plug housing, single row

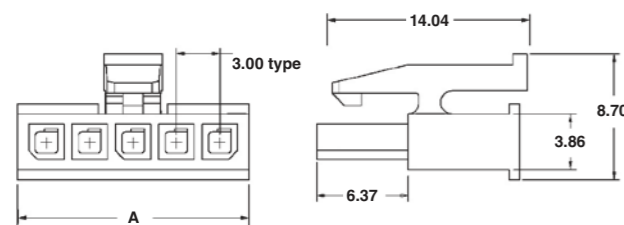

Positions	Dimension A	Part number
2	7	1445022-2
3	10	1445022-3
4	13	1445022-4
5	16	1445022-5
6	19	1445022-6

### Plug housing, multi-row

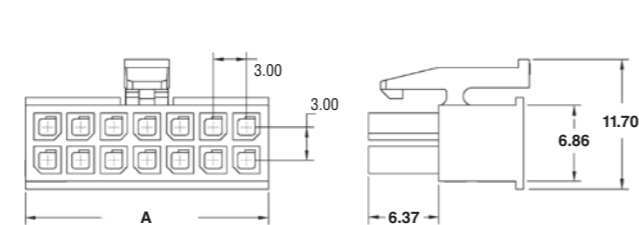

Positions	Dimension A	Part number
2	4	794617-2
4	7	794617-4
6	10	794617-6
8	13	794617-8
10	16	1-794617-0
12	19	1-794617-2
16	25	1-794617-6
20	31	2-794617-0
24	37	2-794617-4

### Receptacle housing, single-row, free hanging

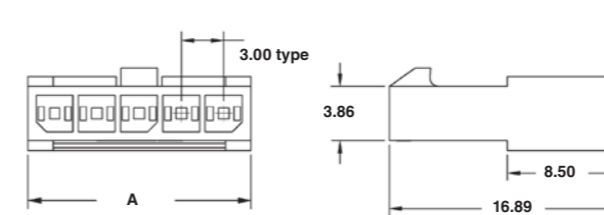

Positions	Dimension A	Part number
2	6.85	1445049-2
3	9.85	1445049-3
4	12.85	1445049-4
5	15.85	1445049-5
6	18.85	1445049-6

### Receptacle housing, multi-row, free hanging

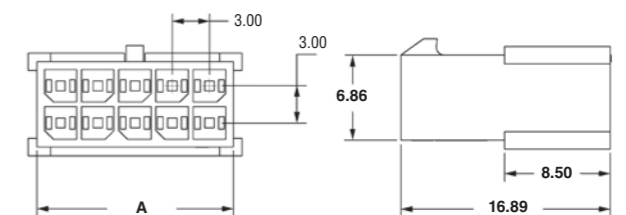

Positions	Dimension A	Part number
2	3.85	794616-2
4	6.85	794616-4
6	9.85	794616-6
8	12.85	794616-8
10	15.85	1-794616-0
12	18.85	1-794616-2
16	24.85	1-794616-6
20	30.85	2-794616-0
24	36.85	2-794616-4

### Receptacle housing, panel mount, single-row

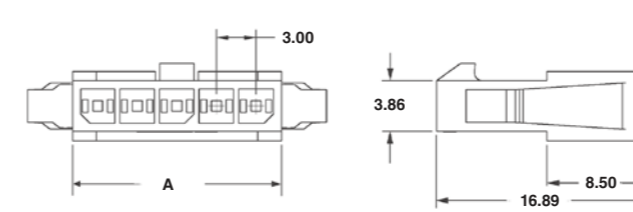

Positions	Dimension A	Part number
2	6.85	1445048-2
3	9.85	1445048-3
4	12.85	1445048-4
5	15.85	1445048-5
6	18.85	1445048-6

### Receptacle housing, panel mount, multi-row

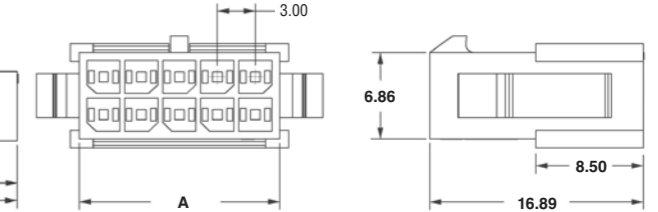

Positions	Dimension A	Part number
2	3.85	794615-2
4	6.85	794615-4
6	9.85	794615-6
8	12.85	794615-8
10	15.85	1-794615-0
12	18.85	1-794615-2
16	24.85	1-794615-6
20	30.85	2-794615-0
24	36.85	2-794615-4

### Contacts, brass tin-plated



Wire size [mm <sup>2</sup> ]	Insulation diameter [mm]	Part number	
		Socket contacts	Pin contacts
0.20-0.50	0.89-1.52	794610-1	1-794612-0
0.05-0.12	0.89-1.52	794611-1	1-794613-0

Also available on reels

## Tools



Description	Wire size [mm <sup>2</sup> ]	Wire cross section [AWG]	Insulation diameter [mm]	Part number
CERTI-CRIMP II hand tool	0.20-1.42	24-16	1.14-2.54	91505-1
CERTI-CRIMP II hand tool	0.05-0.12	30-26	1.52 max.	91502-1
SDE ERGOCRIMP hand tool	0.05-0.50	30-20	0.89-1.52	91391-1
Extraction tools for pin contacts	-	-	-	843996-6
Extraction tools for socket contacts	-	-	-	1586344-1

## Mini Universal Mate-N-Lok connector system

Compact free hanging or panel mount connector system

## FEATURES

- Voltage rating/Current rating: 600 V/9.5 A
- Temperature range: -55°C to +105°C
- Available positions: 1-15
- Housing material: Polyamide
- VDE, UL, CSA approved

## APPLICATION

- Household appliances
- Indoor and outdoor lighting
- Medical equipment
- Security systems
- Industrial controls
- HVAC system controls
- Storage and networking systems

## BENEFITS

- ♦ 4.14 mm centreline connector system
- ♦ Suitable for free hanging or panel mount
- ♦ Pin and socket contacts can be intermixed in the same housing
- ♦ Polarised housing to prevent polarity reversal
- ♦ Housing with positive locking

## 1, 2 and 3 positions, single-row

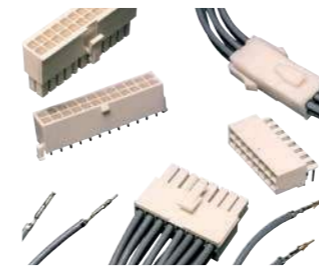

Positions	Dimensions [mm]				Part number		
	A	B	C	D	Plug housing	Receptacle housing	
1	-	-	-	-	172164-1	-	172156-1
2	9.8	10.79	12.39	11.78	172165-1	172157-1	172233-1
3	14	15	16.61	16	172166-1	172158-1	172234-1

## 1 position, free hanging

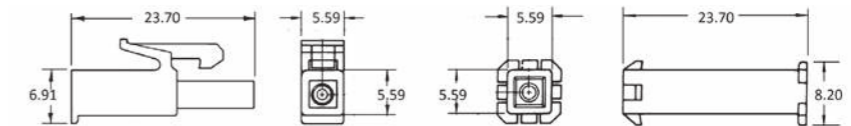

## 2 and 3 positions, single row

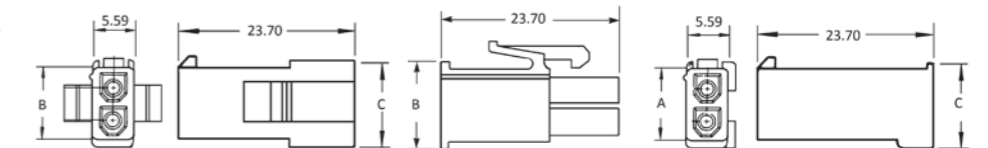

## 4 and 6 positions, double row

Positions	Dimension A [mm]	Part number	
		Plug housing	Receptacle housing
4	9.8	172167-1	172159-1
6	14	172168-1	172160-1

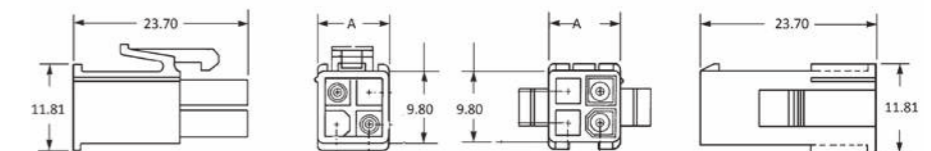

## 9, 12 and 15 positions, multi-row

Positions	Dimension A [mm]	Part number	
		Plug housing	Receptacle housing
9	14	172169-1	172161-1
12	18.19	172170-1	172162-1
15	22.4	172171-1	172163-1

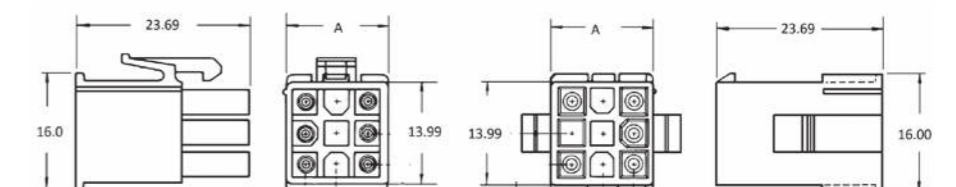

## Contacts, loose piece



Wire range [mm <sup>2</sup> ]	Insulation diameter [mm]	Surface	Part number	
			Pin contacts	Socket contacts
0.12-0.30	1.20-1.80	CuZn, pre-tinned	170363-1	170365-1
		CuZn, gold-plated	170363-3	170365-3
0.30-0.89	1.050-2.40	CuZn, pre-tinned	170364-1	170366-1
		CuZn, gold-plated	170364-3	170366-3

## Tools



Description	Wire size [mm <sup>2</sup> ]	Wire size [AWG]	Insulation diameter [mm]	Part number
SDE PRO-CRIMPER III hand tool	0.14-0.32	26-22	1.19-1.75	90758-1
SDE PRO-CRIMPER III hand tool	0.32-0.96	22-18	1.50-2.39	90759-1
CERTI-LOK hand tool	0.3-0.9	-	1.50-2.40	734202-1

## Insertion and extraction tool



Description	Part number
Extraction tool	189727-1
Insertion tool	455830-1

## Universal MATE-N-LOK connector system

Universal free hanging or panel mount connector system

## FEATURES

- Voltage rating/Current rating: 600 V/19 A
- Temperature range: -55°C to +105°C
- Flammability class according to UL 94 V-0 and V-2
- VDE, UL and CSA approved

## APPLICATION

- Industrial controls
- Welding equipment
- Production equipment
- Power supplies
- Architectural lighting

## BENEFITS

- ♦ 6.35 mm contact pitch connector system
- ♦ Pin and socket contacts can be intermixed in the same housing
- ♦ Polarised
- ♦ Suitable for free hanging or panel mount
- ♦ Suitable for conductor insulation diameters up to 5.1 mm

## Plug and receptacle housing



Positions	Dimensions A [mm]	Part number			
		UL94 V-2 natural		UL94 V-0 white	
		Plug housing	Receptacle housing	Plug housing	Receptacle housing
2	13.97	1-480698-0	1-480699-0	350777-1	350778-1
3	20.32	1-480700-0	1-480701-0	350766-1	350767-1
4	26.67	1-480702-0	1-480703-0	350779-1	350780-1
5	33.02	1-480763-0	1-480764-0	350809-1	350810-1
6	-	1-480704-0	1-480705-0	350715-1	350781-1
9	20.32	1-480706-0	1-480707-0	350720-1	350782-1
12	26.67	1-480708-0	1-480709-0	350735-1	350783-1
15	33.02	1-480710-0	1-480711-0	350736-1	350784-1

2, 3, 4 and 5 positions,  
single row

## 6 positions, multi-row

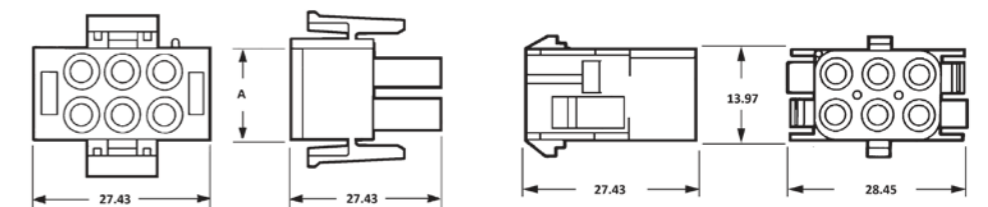
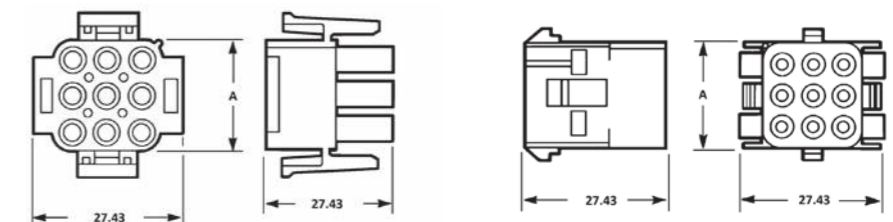
9, 12 and 15 positions,  
multi-row

## Contacts, loose piece

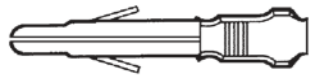

Wire range [mm <sup>2</sup> ]	Wire range [AWG]	Insulation diameter [mm]	Surface	Part number	
				Pin contacts	Socket contacts
0.20-0.80	24-18	1.00-2.50	CuZn, pre-tinned	926896-1	926895-1
0.50-2.10	20-14	1.50-3.30	CuZn, pre-tinned	926894-1	926893-1
			CuSn, gold-plated	926894-3	926893-3

## Seal elements



Positions	Part number	
	Intermediate seal	Wire seal
2	794269-1	794270-1
3	749271-1	794272-1
4	794273-1	794274-1
6	794275-1	794276-1
9	794277-1	794278-1
12	794279-1	794280-1
15	794281-1	794282-1

**Note:** Two wire seals and one intermediate seal are required for a tightly sealed connection!  
Insulation diameters < 2.8 to 3.3 mm are approved for sealing classes IP57.  
Insulation diameters from 1.5 to 2.8 mm are approved for IP56.

## Tools



Description	Wire size [mm <sup>2</sup> ]	Wire cross section [AWG]	Insulation diameter [mm]	Part number	
				Hand tool without die	Die
ERGOCRIMP hand tool	0.20-0.82	24-18	Max.: 2.50	539635-1	539680-2
ERGOCRIMP hand tool	0.20-2.00	-	1.00-3.30	-	539746-2
ERGOCRIMP hand tool	0.50-1.50	-	1.40-2.40	-	539652-2
SDE PRO-CRIMPER III hand tool with die	0.50-2.10	20-14	Max. 3.30	58637-1	incl.

## Insertion and extraction tools



Description	Part number
Extraction tool	539972-1
Spare tube for 539972-1	5-1579007-0
Insertion tool	455830-1

## VAL-U-LOK connector system

4.2 mm system for numerous signal and power applications

## FEATURES

- Voltage rating/Current rating: 600 V/9 A
- Temperature range: -55°C to +125°C
- Flammability class according to UL 94V-2. 94V-0 on request
- Available positions: 2-24
- Housing material: Nylon
- Crimp contacts are available loose for processing with a hand tool or on reels for mechanical processing
- VDE, UL, CSA approved

## APPLICATION

- Household appliances
- Indoor and outdoor lighting
- Security systems
- Industrial controls
- HVAC system controls
- Storage and networking systems

## BENEFITS

- 4.2 mm centreline connector system
- Suitable for free hanging or panel mount
- Available in black, red and blue
- Contacts fully enclosed in the housing
- Polarised housing to prevent polarity reversal

## Single row

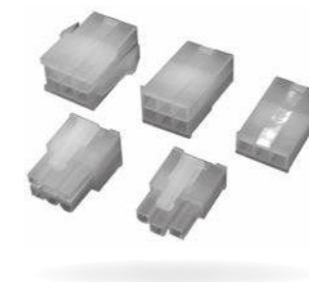

Positions	Part number		
	Receptacle housing panel mount	Receptacle housing free hanging	Plug housing
3	1586101-3	1586103-3	1586105-3
4	1586022-4	1586024-4	1586026-4
5	1586022-5	1586024-5	1586026-5

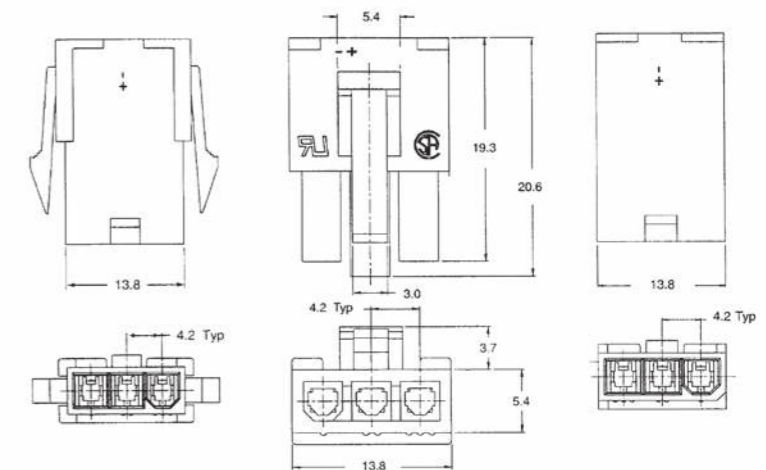

## Double row

Positions	Part number		
	Receptacle housing panel mount	Receptacle housing free hanging	Plug housing
2	794953-2	1586000-2	794954-2
4	794953-4	1586000-4	794954-4
6	794953-6	1586000-6	794954-6
8	794953-8	1586000-8	794954-8
10	1-794953-0	1-1586000-0	1-794954-0
12	1-794953-2	1-1586000-2	1-794954-2
16	1-794953-6	1-1586000-6	1-794954-6
20	2-794953-0	2-1586000-0	2-794954-0
24	2-794953-4	2-1586000-4	2-794954-4

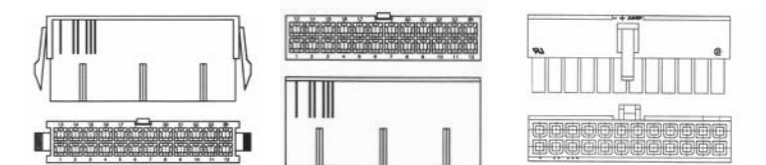



## Contacts

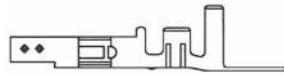

Wire range [mm <sup>2</sup> ]	Wire range [AWG]	Material	Part number	
			Pin contacts	Socket contacts
0.12-0.4	26-22	CuZn, pre-tinned	1586316-1	1586317-1
0.4-0.9	22-18	CuZn, pre-tinned	1586314-1	1586315-1
1.3	16	CuZn, pre-tinned	1586840-1	1586841-1

## Tools



Description	Wire size [mm <sup>2</sup> ]	Wire cross section [AWG]	Insulation diameter [mm]	Part number
SDE PRO-CRIMPER III hand tool	0.14-0.35	26-22	1.19-1.75	91387-1
SDE PRO-CRIMPER III hand tool	0.35-0.82	22-18	1.50-2.41	91388-1
SDE PRO-CRIMPER III hand tool	1.3	16	1.80-3.09	1976444-1
CERTI-LOK hand tool without die	0.14-0.82	26-18	1.50-2.40	2-1579005-1
Die with locator				2-1579021-8
Extraction tool	n/a	n/a	n/a	1586343-1

## Amplimate HD-20 Crimp D-Sub

D-Sub connector for crimp termination



## FEATURES

- Current rating 3.7 A max
- Dielectric strength: 1000 V AC min
- Temperature range: -55°C to +105°C
- Flammability rating: UL 94 V-0

## APPLICATION

- Data, signal, control and power applications

## BENEFITS

- Standard crimp termination
- available in 9, 15, 25 and 37 positions
- Allows selective loading of contacts
- Fully intermateable with industry standard products

## Pin connector



Positions	Part number
9	167292-1
15	167293-1
25	167294-1
37	167295-1

## Socket connector

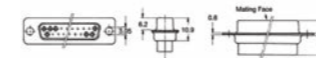

Positions	Part number
9	164531-4
15	164532-4
25	164533-4
37	164534-4

## Pin contact for pin connector

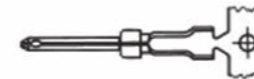

Wire range [AWG] / [mm <sup>2</sup> ]	Small reels of 500 contacts	Loose contacts (contents 100)
24-20 AWG / 0.20-0.56 mm <sup>2</sup>	5-166053-1	166293-1
28-24 AWG / 0.08-0.22 mm <sup>2</sup>	5-166054-1	166294-1

## Socket contact for socket connector

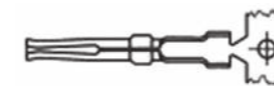

Wire range [AWG] / [mm <sup>2</sup> ]	Small reels of 500 contacts	Loose contacts (contents 100)
24-20 AWG / 0.20-0.56 mm <sup>2</sup>	5-166051-1	166291-1
28-24 AWG / 0.08-0.22 mm <sup>2</sup>	5-166052-1	166292-1

## Hand tool for Premium installations

Description	Wire range [AWG] / [mm <sup>2</sup> ]	Part number
CERTI-CRIMP 2 hand tool	28-20 AWG / 0.20-0.08 mm <sup>2</sup>	91503-1

## Hand tool for industrial applications and service

Description	Wire range [AWG] / [mm <sup>2</sup> ]	Part number
Hand tool (HDP-20)	28-20 AWG / 0.20-0.08 mm <sup>2</sup>	169341-1

## Insertion and extraction tool

Description	Part number
Insertion and extraction tool for pin and socket contacts	91285-1

## Amplimite HD-20 D-Sub with solder cup

D-Sub connectors for soldering

### FEATURES

- Two-piece plastic insert (thermoplastic) according to UL 94V-0
- Current carrying capacity: 3 A
- UL approved



### APPLICATION

- Data, signal, control and power applications

### BENEFITS

- Cable mount solder termination
- Gold plated contacts
- Intermateable with other D-Sub connectors

### Pin connector

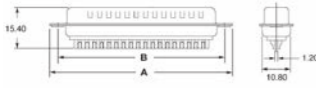

Positions	Dimensions [mm]		Part number
	A	B	
9	30.80	24.99	5-747904-2
15	39.20	33.32	5-747908-2
25	53.01	47.04	5-747912-2
37	69.40	63.50	5-747916-2

### Socket connector

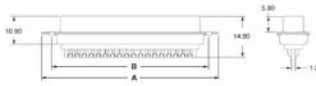

Positions	Dimensions [mm]		Part number
	A	B	
9	30.80	24.99	5-747905-2
15	39.20	33.32	5-747909-2
25	53.01	47.04	5-747913-2
37	69.40	63.50	5-747917-2

## Amplimite plastic covers

Cost effective hood for D-Sub connectors

### FEATURES

- Compact, attractive design
- Wire range: 3.0 to 11.0 mm
- Temperature range: -55°C to +105°C
- Flammability rating: UL94V-2

### APPLICATION

- Data and signal processing

### BENEFITS

- Low-cost plastic cover with cable clamp for D-Sub connectors
- Solution for unscreened applications
- Includes jackscrews
- Lightweight
- Wide range of cable sizes



Description	Housing size	Positions	Part number
D-sub cover 9 positions	1	9	1991253-9
D-sub cover 15 positions	2	15	1-1991253-5
D-sub cover 25 positions	3	25	2-1991253-5
D-sub cover 37 positions	4	37	3-1991253-7

## Amplimite ADK die-cast backshells

Shielded D-Sub hoods

### FEATURES

- 4 shell sizes for 9 to 37 position D-Sub connectors
- Straight (180°) or 45° cable entry
- For high data integrity links
- Temperature range: -40°C to +120°C
- Cable insulation diameter: 4.00 to 13.00 mm

### APPLICATION

- EMI /RFI shielding for computer peripherals, industrial applications

### BENEFITS

- Die-cast backshell with strain relief for D-Sub connectors
- Complete kit comprising shells, jackscrews and four sizes of cable grommets
- Full crimped termination to the cable braid for greater screening integrity and improved cable strain relief
- Lightweight

### 180° cable entry



Description	Positions	Part number
D-sub cover 9 positions	9	1478762-9
D-sub cover 15 positions	15	1-1478762-5
D-sub cover 25 positions	25	2-1478762-5
D-sub cover 37 positions	37	3-1478762-7

### 45° cable entry

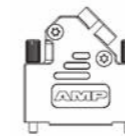

Description	Positions	Part number
D-sub cover 9 positions	9	1478763-9
D-sub cover 15 positions	15	1-1478763-5
D-sub cover 25 positions	25	2-1478763-5
D-sub cover 37 positions	37	3-1478763-7

## Industrial Ethernet RJ45

Fast Ethernet and Gigabit Ethernet connectors for field installation



### FEATURES

- Fast Ethernet and Gigabit Ethernet capable
- Field installation with fast termination system

### APPLICATION

- Industrial controls in harsh production environments
- Control cabinet applications in automation and network environments

### BENEFITS

- ♦ Conventional termination technology
- ♦ 45° angled version available
- ♦ IP20 version with supporting frame available

Description	Cable entry alignment	Positions	Part number
RJ-45 modular plug kit, 4 positions, contact 1, 2, 3 and 6	180° straight	4	1903526-1
RJ 45 modular plug kit, 8 positions	180° straight	8	1903527-1
Supporting frame including 4 screws (without connector)	-	-	1987306-1
Supporting frame AMP-Twist 6S SL jack category 6	-	8	1987671-1
Supporting frame including SL series 110Connect jack category 5E	-	-	1987672-1
RJ-45 modular plug kit, 4 positions	angled 45°	4	1987236-1
RJ-45 modular plug kit, 8 positions	angled 45°	8	1987236-3

## Industrial USB circular connector

Quick connect designed for use in harsh environments



### FEATURES

- USB 2.0 capable
- Temperature range: -40°C to + 85°C
- Sealing IP67
- Housing and coupling ring: UL94 V-0
- Cable fitting, modular plug: UL94V-2
- Sealing ring: UL94 HBF

### APPLICATION

- Industrial automation and machinery, industrial PC solutions, motion control, robotics

### BENEFITS

- ♦ USB connection for use in harsh environments
- ♦ Plastic housing with quick connect bayonet locking
- ♦ Through-panel mating receptacles
- ♦ Polarised for correct mating between connector halves
- ♦ UV resistant housing material

Description	USB series	Part number
Industrial circular USB plug connector kit type A	A	1954637-1
Industrial circular USB plug connector kit type B	B	1954640-1
Industrial USB receptacle connector kit	A to A	1954643-1
Industrial USB receptacle connector kit	B to A	1954646-1

## M8/M12 connectors



### FEATURES

- IP67 rated product for cable assemblies and panel mount
- IP68 rated product for field terminable products
- M8 product family - 3 and 4 positions
- M12 product family - 3, 4, 5 and 8 positions
- PVC and PUR jacketed cable available
- Single and double ended cable assemblies available
- Shielded and unshielded products available
- Panel and PCB mount available
- Field terminable products

### APPLICATION

- TE Connectivity offers a range of M8/M12 products for use in industrial and factory automation. This connector system conforms to established industry standards and consists of single-ended cable assemblies in lengths of two to ten metres. The cable assemblies are available with both PVC and PUR jacketed cables for indoor and outdoor use. They also include options for straight or right angle over-moulded connector ends, shielding and LEDs. Panel mount products are offered for both PCB mount or solder cup. Field terminable products are available with both screw-type or solder cup terminations. Y-adapters are available for splitting of control signals and double-ended cable assemblies are available upon request.

## CPC circular connectors series 1

Large selection of housings with flange for panel mount and as free hanging couplings available



### FEATURES

- Approved for up to 600 V/13 A
- Operating temperature range: -55°C to +125°C
- The majority of CPC connectors are UL 94 V-0 approved and made of stabilised, heat resistant, self-extinguishing plastic
- 4 shell sizes: 4 to 37 positions
- UL, VDE & CSA approved

### APPLICATION

- Standard density signal and low-voltage current applications using type III+ contacts

### BENEFITS

- Polarised
- Connector as free hanging coupling and for chassis mount with flange
- Quick connect/disconnect capability with thread assist, positive detent coupling
- Pin housing with shroud
- Extensive range of accessories available

### Housing for size 16 contacts



Housing size	Positions	Type	Part number		
			Receptacle housing with rectangular flange for pin contacts	Receptacle housing free hanging for pin contacts	Plug housing for socket contacts (without pin protection)
11	4	Standard Sex	182917-1	182919-1	182647-1
13	9	Standard Sex	182922-1	183079-1	182645-1
17	9	Standard Sex	211767-1	–	211766-1
17	14	Standard Sex	183040-1	–	183039-1
17	16	Standard Sex	182916-1	183077-1	182642-1
23	24	Standard Sex	183075-1	206838-2	183073-1
23	37	Standard Sex	182918-1	206151-2	182923-1

### Inverted housing for size 16 contacts



Housing size	Positions	Type	Part number		
			Inverted receptacle housing with rectangular flange for socket contacts	Inverted receptacle housing free hanging for socket contacts	Inverted plug housing with pin contact (with pin protection)
11	4	Reverse Sex	182921-1	183083-1	182651-1
17	9	Reverse Sex	211769-1	211769-3	211768-1
17	14	Reverse Sex	182641-1	206043-3	182649-1
23	37	Reverse Sex	182920-1	206306-2	182926-1

### Size16 TYPE III+ single contact

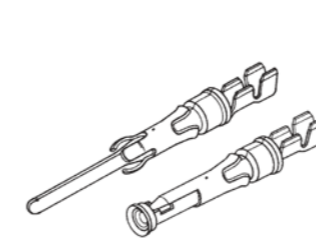

Wire range [mm²]	AWG	Insulation diameter [mm]	Material and plating	Part number	
				Pin contact	Socket contact
0.12-0.20	26-24	0.9-1.4	CuZn, tin-plated	163090-1	163092-1
			CuZn, 0.76 µm gold-plated	163090-2	163092-2
0.20-0.56	24-20	1.15-1.80	CuZn, tin-plated	163086-1	163088-1
			CuZn, 0.76 µm gold-plated	163086-2	163088-2
0.75-1.50	18-16	2.0-2.5	CuZn, tin-plated	163082-1	163084-1
			CuZn, 0.76 µm gold-plated	163082-2	163084-2

### Size 16 TYPE III+ earthing pin contact

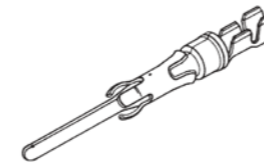

Wire range [mm²]	AWG	Insulation diameter [mm]	Material and plating	Part number
0.20-0.56	24-20	1.15-1.80	CuZn, tin-plated	164163-1
			CuZn, 0.76 µm gold-plated	164163-2
0.80-1.40	18-16	2.0-2.5	CuZn, tin-plated	164164-1
			CuZn, 0.76 µm gold-plated	164164-2

### Hand tool



Description	Wire range [mm²]	Insulation diameter [mm]	Part number
Mini CERTI-LOK hand tool	0.03-0.09	0.35-0.80	169475-1
	0.12-0.22	0.90-1.40	
	0.20-0.56	1.10-1.80	
Mini CERTI-LOK hand tool	0.75-1.5	2.0-2.5	169422-1
	1.0-2.5	2.5-3.8	
SDE PRO-CRIMPER III hand tool without die	–	–	354940-1
SDE PRO-CRIMPER III die	24-20 AWG	1.02-2.03	58495-2
	18-16 AWG	2.03-2.54	
	24-16 AWG	1.02-2.54	

### Tool



Description	Part number
Extraction tool	539972-1
Spare tube for 539972-1	5-1579007-0

## CPC circular connector series 3

A wide range of housings with flange for chassis mount and as free hanging couplings available



### FEATURES

- Approved for up to 600 V/13 A
- Operating temperature range: -55°C to +125°C
- The majority of CPC connectors are UL 94 V-0 approved and made of stabilised, heat resistant, self-extinguishing plastic
- 2 housing sizes: 4 to 7 positions
- UL, VDE & CSA approved

### APPLICATION

- Low contact density, current applications up to 35 A

### BENEFITS

- Polarised for correct mating between connectors
- Connector as free hanging coupling and for chassis mount with flange
- Quick connect/disconnect capability with thread assist, positive detent coupling
- Pin housing with shroud
- Extensive range of accessories available

### Housings for size XII contacts

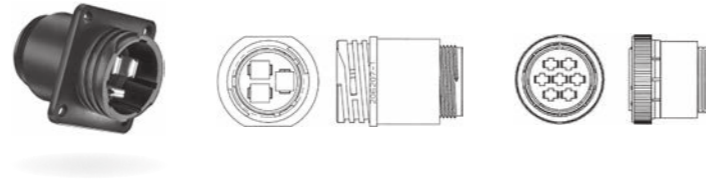

Housing size	Positions	Type	Part number		
			Receptacle housing with rectangular flange for pin contacts	Receptacle housing free hanging for pin contacts	Plug housing for socket contacts (without pin protection)
17	3	Standard Sex	206036-2	206207-1	206037-2
23	7	Standard Sex	206137-1	206137-2	206136-1

### Inverted housing for size type XII contacts

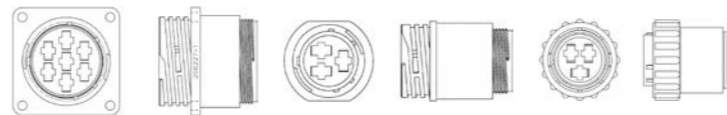

Housing size	Positions	Type	Part number		
			Inverted receptacle housing with rectangular flange for socket contacts	Inverted receptacle housing free hanging for socket contacts	Inverted plug housing for pin contacts (with pin protection)
17	3	Reverse Sex	206425-1	206425-2	206426-1
23	7	Reverse Sex	206227-1	206227-2	206226-1

### Type XII contacts single



Wire range [mm <sup>2</sup> ]	AWG	Insulation diameter [mm]	Material and plating	Part number		
				Pin contact	Socket contact	Earthing pin
1.25-3.00	16-12	3.4-4.0	CuZn, 0.76 µm gold-plated	66261-2	66740-6	66262-2
			CUZn, silver-plated	66261-4	66740-2	
5.0-6.0	10	4.8-5.6	CuZn, 0.76 µm gold-plated	66259-2	66741-6	66260-2
			CUZn, silver-plated	66259-4	66741-2	

### Hand tool



Description	Wire range [mm <sup>2</sup> ]	Insulation diameter [mm]	Part number
ERGOCRIMP hand tool without die	-	-	539635-1
ERGOCRIMP die	0.2-0.5	1.1-1.8	539668-2
	0.75-1.5	2.0-2.5	
	1.5-2.5	3.6-4.2	
Heavy Head Hand Tool (HHHT) hand tool	16-10	3.7-4.2	90382-2
	10-8	4.8-5.6	90384-1

### Tool

Description	Part number
Extraction tool	7-1579008-6
Spare blade for 7-1579008-6	9-519706-3

## CPC Series I & III accessories

Cable clamps and covers for improved strain relief and protection

### Cable clamp standard size



Housing size	Max. cable outer diameter [mm]	Part number
11	8.36	182658-1
13	11.51	182663-1
17	11.51	182655-1
23	17.86	182652-1

### Cable clamp for large cable diameters

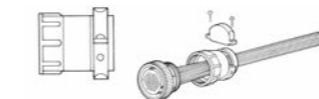

Housing size	Max. cable outer diameter [mm]	Part number
11	11.51	182928-1
13	17.86	207008-5
17	17.86	182661-1
23	28.58	182930-1

### Covers with plastic strap



Housing size	For CPC series	Part number
11	I	206903-2
13	I	211870-2
17	I & III	207445-3
23	I & III	207446-3

## SOLARLOK PV4 connectors

The latest connector generation for high-voltage applications in photovoltaics



### FEATURES

- 1000 V (UL) 1000 V (TÜV)
- Current carrying capacity (at 85°C):  
UL 20 A and TÜV 35 A for 4.0 mm<sup>2</sup>  
UL 30 A and TÜV 40 A for 6.0 mm<sup>2</sup>
- Contact resistance:  
typical 0.25 mΩ
- Temperature range:  
-40°C to +115°C
- Dimensions:  
Diameter 18.7 mm
- Degree of protection:  
IP68 (1 m/24 h)
- Contact: Tin/Copper
- Contact surface: Tin-plated

### APPLICATION

- Connectivity systems for PV solutions
- Connection between panels
- Connection to inverter

### BENEFITS

- ♦ Low contact resistance offers less power loss
- ♦ Conforms to NEC2008 directive
- ♦ Audible snap-in and lock mating design
- ♦ Highest IP68 protection in its class
- ♦ Quick and easy assembly with conventional tools

### Female cable coupler (socket)

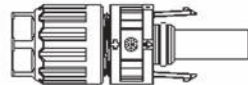

Description	Coding	Wire size [mm <sup>2</sup> ]	Part number	
			Cable outer diameter 5.8 mm to 8.0 mm	Cable outer diameter 4.5 mm to 6.2 mm
Kit with socket contact (packing 1000 pieces)	Plus	4.0 -6.0	1971862-1	1971862-2
Kit with socket contact (packing 100 pieces)	Plus	4.0 -6.0	2-1971862-1	2-1971862-2

### Male cable coupler (pin)

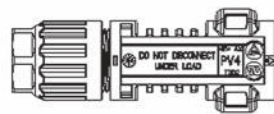

Description	Coding	Wire size [mm <sup>2</sup> ]	Part number	
			Cable outer diameter 5.8 mm to 8.0 mm	Cable outer diameter 4.5 mm to 6.2 mm
Kit with pin contact (packing 1000 pieces)	Minus	4.0 -6.0	1971861-1	1971861-2
Kit with pin contact (packing 100 pieces)	Minus	4.0 -6.0	2-1971861-1	2-1971861-2

### Contacts separate

Description	Packaging:	Wire size [mm <sup>2</sup> ]	Part number
Socket	In strip form	4.0-6.0	1971858-2
Socket	Bulk	4.0-6.0	1971858-3
Pin	In strip form	4.0-6.0	1971857-2
Pin	Bulk	4.0-6.0	1971857-3

### Tools



Description	Wire size [mm <sup>2</sup> ]	Part number
Hand crimping tool for PV4 contacts	4.0-6.0	6-1579014-8
Stripping tool	2.5-6.0	4-1579002-2
PV4 assembly tool	–	1971903-1
Hexagon head (17 mm) for torque wrenches	–	2232097-1

### Dust covers

Description	Part number
for socket housings	2232227-1
for pin housings	2232228-1

## SOLARLOK Standard Line connectors

Rugged connectors for high-voltage solar applications

### FEATURES

- Current carrying capacity (at 85°C): 25 A
- Dielectric strength: 1000 V DC
- Contact resistance (typical): 1 m OHM
- Temperature range: -40°C to +115°C
- Connector dimensions: Diameter 18 mm
- Degree of protection (plugged): IP67
- Contacts: Silver-plated
- UL approved
- TUV approved

### APPLICATION

- Connectivity systems for PV solutions
- Connection between panels

### BENEFITS

- Simple use on site
- Mechanical locking
- High current carrying capacity and temperature resistance
- Coded housing prevents polarity reversal

### Female contact socket



Description	Coding	Wire size [mm²]	Part number	
			Cable outer diameter 5.8 mm to 8.0 mm	Cable outer diameter 4.5 mm to 6.2 mm
Kit with turned contacts	Plus	2.5	1394462-1	4-1394462-6
Kit with turned contacts	Plus	4	1394462-3	4-1394462-8
Kit with turned contacts	Plus	6	5-1394462-5	6-1394462-3
Kit with turned contacts	Minus	2.5	1394462-2	4-1394462-7
Kit with turned contacts	Minus	4	1394462-4	4-1394462-9
Kit with turned contacts	Minus	6	5-1394462-6	6-1394462-4

### Male cable coupler



Description	Coding	Wire size [mm²]	Part number	
			Cable outer diameter 5.8 mm to 8.0 mm	Cable outer diameter 4.5 mm to 6.2 mm
Kit with turned contacts	Plus	2.5	1394461-1	1394461-7
Kit with turned contacts	Plus	4	1394461-3	7-1394461-0
Kit with turned contacts	Plus	6	6-1394461-5	7-1394461-3
Kit with turned contacts	Minus	2.5	1394461-2	1394461-8
Kit with turned contacts	Minus	4	1394461-4	7-1394461-1
Kit with turned contacts	Minus	6	6-1394461-6	7-1394461-4
Kit with turned contacts	Neutral	2.5	6-1394461-1	6-1394461-3
Kit with turned contacts	Neutral	4	6-1394461-2	7-1394461-2
Kit with turned contacts	Neutral	6	6-1394461-4	7-1394461-5

### Parallel connection via T-branch



Description	Coding	Part number
T-branch male-to-male	Plus	1534611-1
T-branch male-to-male	Minus	1534611-2

### Parallel connection via T-branch



Description	Coding	Part number
T-branch female-to-male	Plus	1740277-1
T-branch male-to-female	Minus	1740277-2

### Tools



Description	Wire size [mm²]	Part number
Hand crimping tool for turned contacts including die and locator	2.5-4.0	3-1579014-7
Hand crimping tool for turned contacts including die and locator	4.0-6.0	1-1579004-2
Extraction tool	2.5-6.0	9-1579018-9
Stripping tool	2.5-6.0	4-1579002-2
Hexagon head (13 mm) for torque wrenches	–	523229-1
Torque wrench	–	2161345-1
Assembly kit + 100 cable couplers and crimp contacts	4.0-6.0	1534858-1
SOLARLOK Installer Starter Kit + 20 cable couplers and crimp contacts	–	5-1579010-4

## SOLARLOK grounding system

Grounding system for photovoltaic applications



### FEATURES

- Short-circuit test (UL647)
  - 6 AWG = 1530 A (6 seconds)
  - 8 AWG = 1180 A (4 seconds)
  - 10 AWG = 750 A (4 seconds)
  - 12 AWG = 470 A (4 seconds)
- Secureness test (UL 486A-B)
  - 6 AWG = 18 lbs (30 minutes)
  - 8 AWG = 8 lbs (30 minutes)
  - 10 AWG = 5 lbs (30 minutes)
  - 12 AWG = 5 lbs (30 minutes)
- Pull out test (UL 486A-B)
  - 6 AWG = 100 lbs (1 minute)
  - 8 AWG = 90 lbs (1 minute)
  - 10 AWG = 80 lbs (1 minute)
  - 12 AWG = 70 lbs (1 minute)
- UL467 listed
- UL file #E69905
- Precondition for UL1703 Solar panel listing
- CSA C22.2 No. 41-07

### APPLICATION

- Grounding system for photovoltaic installations

### BENEFITS

- Rugged and compact hex bolt design made of stainless steel
- Quick and easy mounting procedure
- Bottom edge feature cuts through anodised aluminium surface when securing hex bolt to module frame
- Standard tooling can be used with hex nuts

### Grounding bolt

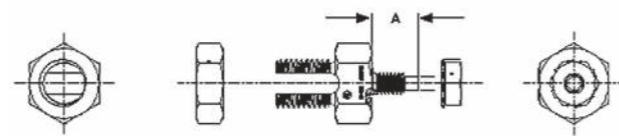

Version	Shank	Dimension A [inch]	Dimension A [mm]	Part number
6-12 AWG	#8-32 UNC	0.38	9.7	2058729-1
Long Shank 6-12 AWG	#10-32 UNF	0.7	17.8	2106831-1

## SOLARLOK Grounding system

Easy to connect grounding system for photovoltaic applications

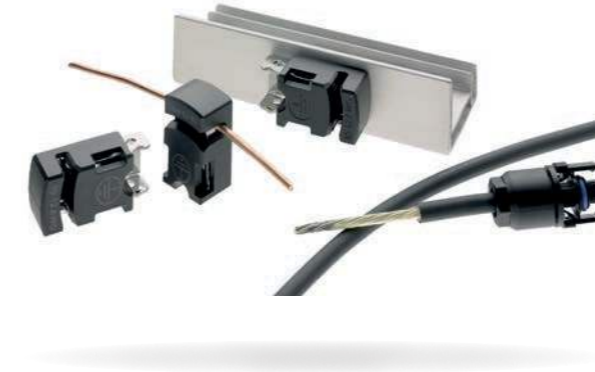

### FEATURES

- Conforms to photovoltaic grounding requirements and the National Electric Code (NEC) 2008
- Conforms to the grounding requirements for solid copper wire
- 12 AWG application will withstand 70 lbs pull
- 10 AWG application will withstand 80 lbs pull
- UL467 listed
- UL file #E69905
- Requirement for UL1703 solar panel listing
- CSA C22.2 No. 41-07

### APPLICATION

- Grounding system for photovoltaic installations

### BENEFITS

- Easy to install with simple tools
- Supplied as an assembled kit including screw
- Offers 4 points of contact to the ground wire for high reliability
- Offers patented contacting to panels (through anodised protective coating)

### Grounding clip for solid copper wire

Bolt	Nut	Wire cross section	Part number
#10-32 thread cutter	None	10-12 AWG	1954381-1
#8-32 pan head	#8-32	10-12 AWG	1954381-2
#8-32 pan head	#8-32 & lock washer	10-12 AWG	1954381-3
#8-32 long head	#8-32 & lock washer	10-12 AWG	1954381-4
#10-32 thread cutter	None	4 & 6 mm <sup>2</sup>	1954381-5

## SOLARLOK cable

Cable designed for harsh environments



### FEATURES

- 1800/3000 VAC 2600 VDC
- Temperature range: -40°C to +125°C
- Wire sizes: 4.0 mm<sup>2</sup> (AWG 12)
- TÜV approved
- UL approved
- Global TÜV and UL 4703

### APPLICATION

- Global solar installations

### BENEFITS

- Over 50 years life expectancy
- Excellent resistance to abrasion
- Excellent flexibility and stripping performance
- Can withstand the lowest temperatures (-60°C) in its class

Wire cross section		Wire construction No. x [mm]	Max. diameter [mm]	Jacket diameter [mm]	Weight [kg/km]	Contents [m]	Part number
A	B						
4	12	56 x 0.31	2.50	6.90 +/-0.10	75.8	500	956298-4
4	12	56 x 0.31	2.50	6.90 +/-0.10	75.8	100	1-956298-4



## CoolSplice Connectors

Insulation displacement connectors for wire-to-wire connections without special tools



### FEATURES

- Suitable for 0.75 mm<sup>2</sup> and AWG 18 solid and stranded wire
- Cable entry diameter max. 7.3 mm
- Wire entry diameter max. 2.85 mm
- Voltage rating 230 V AC current rating 2.5 A max.
- Voltage rating 50 V AC/120 DC current rating 5 A max.
- Temperature range: -40°C to +85°C
- Fits through a 16 mm hole
- UL1977-IEC 60998 listed
- Degree of protection: IP 65 and IP 67

### APPLICATION

- Architectural lighting
- Cabinet lighting
- Residential and office furniture lighting
- Refrigerating lighting
- Security and alarm systems

### BENEFITS

- ♦ Designed to connect a pair of discrete wires or a twin cord cable in line to a pair of discrete wires or twin cord cables
- ♦ The connectors eliminate the need to pre-strip the insulation from the wire conductors and provides a visual controlled termination
- ♦ The push connect buttons provide a more ergonomic wire termination than conventional twist-on-wire connectors
- ♦ Simple push connect button termination
- ♦ Reliable and proven insulation displacement technology
- ♦ Sealed or unsealed connector versions available
- ♦ Visually controllable termination

### Coolsplice for discrete wires



Description	Connection button colour	Degree of protection	Wire range AWG	Wire range [mm <sup>2</sup> ]	Part number
Unsealed	Green	IP 65	18	0.75	293545-1
Sealed	Blue	IP 67	18	0.75	293545-2
Unsealed	Green	IP 65	20-22	0.52/0.33	293545-3
Sealed	Blue	IP 67	20-22	0.52/0.33	293545-4

### Coolsplice for ribbon cable

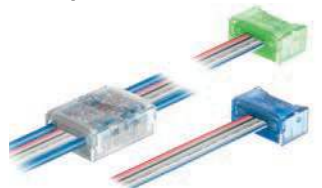

Description	Connection button colour	Degree of protection	Wire range AWG	Wire range [mm <sup>2</sup> ]	Part number
Standard version, cable to cable	transparent	IP 66	18	0.75	5-293521-1
End version with bridge	Blue	IP 66	18	0.75	5-293522-1
End version without bridge	Green	IP 66	18	0.75	5-293522-2

## Heavy-duty industrial connectors

A broad spectrum of connectors for industrial applications



### FEATURES

- Aluminium die-cast alloy or zinc die-cast alloy
- Degrees of protection IP 44/IP 68
- Four different locking mechanisms
- Voltage rating 25 V to 5 kV
- Current rating 10 A to 450 A
- Turned and stamped crimp contacts available
- Cable terminations, screw, cage clamp and crimp available

### APPLICATION

- Industrial machinery, wind energy, railway equipment, switchgear

### BENEFITS

- ♦ Immune to EMC interference
- ♦ Protected against corrosion
- ♦ High mechanical resistance to vibrations and shocks
- ♦ Maximum flexibility in component selection to suit specific application requirements.
- ♦ Different contact crimping tools available

### Housing size 1

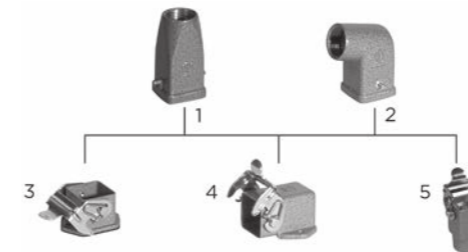

No.	Description	Thread type	Degree of protection	Width [mm]	Length [mm]	Height [mm]	Part number
1	Top cable entry	M16	IP44	26.5	26.5	52.0	1106405-1
2	Side cable entry	M16	IP44	26.5	40.0	49.0	1106406-1
3	Surface mounted housing	–	IP44	28.0	28.0	23.0	1-1102105-2
3	Surface mounted housing with cover	–	IP44	28.0	28.0	28.0	1-1102106-2
4	Angled surface mounted housing	M16	IP44	40.0	40.0	25.0	1106404-1
5	Coupler housing	M16	IP44	24.0	24.0	46.0	1106403-1
5	Coupler housing with cover	PG11	IP44	24.0	24.0	56.0	1-1108759-2

## Contact inserts size 1

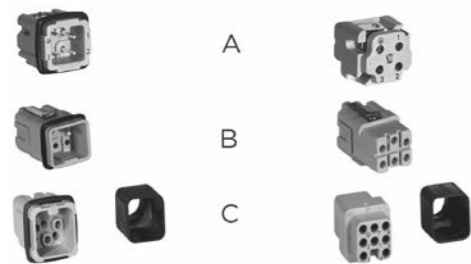

No.	Description	Positions	Current rating [A]	Voltage rating [V]	Type of connection	Part number
A	Pin insert	3 + PE	10	250	Screw	1-1103400-1
A	Socket insert	3 + PE	10	250	Screw	1-1103401-1
A	Pin insert	4 + PE	10	250	Screw	1-1103402-1
A	Socket insert	4 + PE	10	250	Screw	1-1103403-1
B	Pin insert	5 + PE	16	400	Crimp	1102195-1
B	Socket insert	5 + PE	16	400	Crimp	1102194-1
C	Pin insert	7 + PE	10	250	Crimp	2-1103100-3
C	Socket insert	7 + PE	10	250	Crimp	2-1103101-3

## Housing size 5

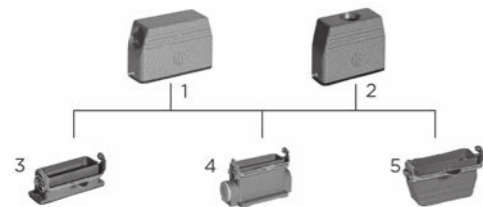

No.	Description	Thread type	Degree of protection	Width [mm]	Length [mm]	Height [mm]	Part number
1	Side cable entry	M20	IP65	29.0	79.5	57.0	1106439-2
2	Top cable entry	M20	IP65	29.0	79.5	57.0	1106439-1
3	Surface mounted housing	–	IP65	29.0	96.0	28.0	1-1102140-2
3	Surface mounted housing with cover	–	IP65	29.0	96.0	28.0	1-1102141-2
4	Angled surface mounted housing	M20	IP65	50.0	102.0	50.0	1103058-1
4	Angled surface mounted housing with cover	M20	IP65	50.0	102.0	50.0	1103058-2
5	Coupler housing	M20	IP65	50.0	92.0	52.0	1106437-1

## Contact inserts size 5

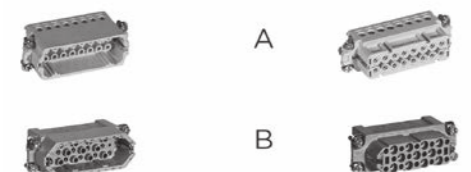

No.	Description	Positions	Current rating [A]	Voltage rating [V]	Type of connection	Part number
A	Pin insert	16 + PE	16	250	Screw	1-1103416-1
A	Socket insert	16 + PE	16	250	Screw	1-1103417-1
A	Pin insert	16 + PE	16	250	Crimp	2-1103416-3
A	Socket insert	16 + PE	16	250	Crimp	2-1103417-3
A	Pin insert	16 + PE	16	250	Cage clamp termination	7-1103416-1
A	Socket insert	16 + PE	16	250	Cage clamp termination	7-1103417-1
B	Pin insert	25 + PE	10	250	Crimp	2-1103108-3
B	Socket insert	25 + PE	10	250	Crimp	2-1103109-3

## Housing size 3

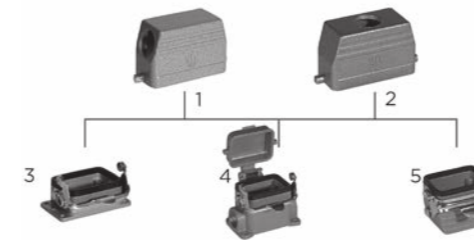

No.	Description	Thread type	Degree of protection	Width [mm]	Length [mm]	Height [mm]	Part number
1	Side cable entry	M25	IP65	43.0	60.0	48.0	1106419-2
2	Top cable entry	M25	IP65	43.0	60.0	48.0	1106419-1
3	Surface mounted housing	–	IP65	43.5	80.0	28.5	1-1102244-2
3	Surface mounted housing with cover	–	IP65	43.5	80.0	28.5	1-1102246-2
4	Angled surface mounted housing	2 x M25	IP65	52.0	83.0	49.5	1103062-1
4	Angled surface mounted housing with cover	2 x M25	IP65	52.0	83.0	73.5	1103062-2
5	Coupler housing	M25	IP65	43.0	60.0	50.0	1106417-1

## Housing size 3 - high type with enlarged wiring space

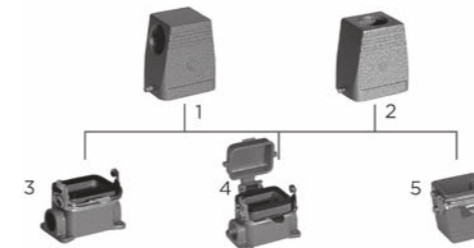

No.	Description	Thread type	Degree of protection	Width [mm]	Length [mm]	Height [mm]	Part number
1	Side cable entry	M32	IP65	43.0	60.0	70.0	1106423-2
2	Top cable entry	M32	IP65	43.0	60.0	70.0	1106423-1
3	Angled surface mounted housing	2 x M32	IP65	57.0	83.0	50.0	1106422-2
4	Angled surface mounted housing with cover	2 x M32	IP65	57.0	83.0	73.5	1106422-1
5	Coupler housing	M32	IP65	43.0	60.0	72.0	1106421-1

## Contact inserts size 3

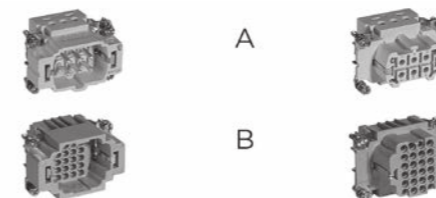

No.	Description	Positions	Current rating [A]	Voltage rating [V]	Type of connection	Part number
A	Pin insert	6 + PE	16	400	Screw	1-1103634-1
A	Socket insert	6 + PE	16	400	Screw	1-1103635-1
A	Pin insert without contacts	6 + PE	16	400	HE/HA crimp contacts	2-1103634-3
A	Socket insert without contacts	6 + PE	16	400	HE/HA crimp contacts	2-1103635-3
A	Pin insert	6 + PE	16	400	Cage clamp termination	7-1103634-1
A	Socket insert	6 + PE	16	400	Cage clamp termination	7-1103635-1
B	Pin insert without contacts	24 + PE	10	250	HN.D crimp contacts	2-1103200-3
B	Socket insert without contacts	24 + PE	10	250	HN.D crimp contacts	2-1103202-3

## Housing size 4 - high type with enlarged wiring space

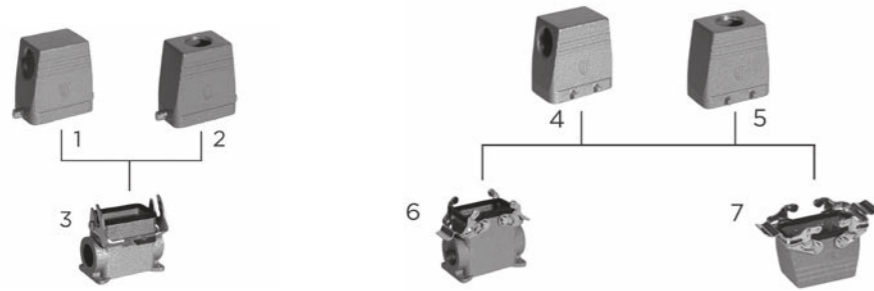

No.	Description	Thread type	Degree of protection	Width [mm]	Length [mm]	Height [mm]	Part number
1	Side cable entry - longitudinal clip	M32	65	43.0	73.0	70.0	1106434-5
2	Top cable entry - longitudinal clip	M32	65	43.0	73.0	70.0	1106434-2
3	Angled surface mounted housing - longitudinal clip	2 x M32	65	57.0	94.0	74.0	1106433-3
4	Side cable entry - locking clip	M32	65	43.0	73.0	70.0	1106434-4
5	Top cable entry - locking clip	M32	65	43.0	73.0	70.0	1106434-1
6	Angled surface mounted housing - locking clip	2 x M32	65	56.0	94.0	74.0	1106433-4
7	Coupler housing - locking clip	M32	65	57.0	73.0	55.5	1106432-2

## Contact inserts size 4

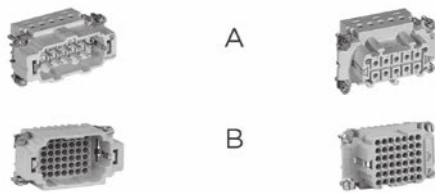

No.	Description	Positions	Current rating [A]	Voltage rating [V]	Type of connection	Part number
A	Pin insert	10 + PE	16	400	Screw	1-1103636-1
A	Socket insert	10 + PE	16	400	Screw	1-1103637-1
A	Pin insert without contacts	10 + PE	16	400	HE/HA crimp contacts	2-1103636-3
A	Socket insert without contacts	10 + PE	16	400	HE/HA crimp contacts	2-1103637-3
A	Pin insert	10 + PE	16	400	Cage clamp termination	7-1103636-1
A	Socket insert	10 + PE	16	400	Cage clamp termination	7-1103637-1
C	Pin insert without contacts	42 + PE	10	250	HN.D crimp contacts	2-1103204-3
C	Socket insert without contacts	42 + PE	10	250	HN.D crimp contacts	2-1103206-3

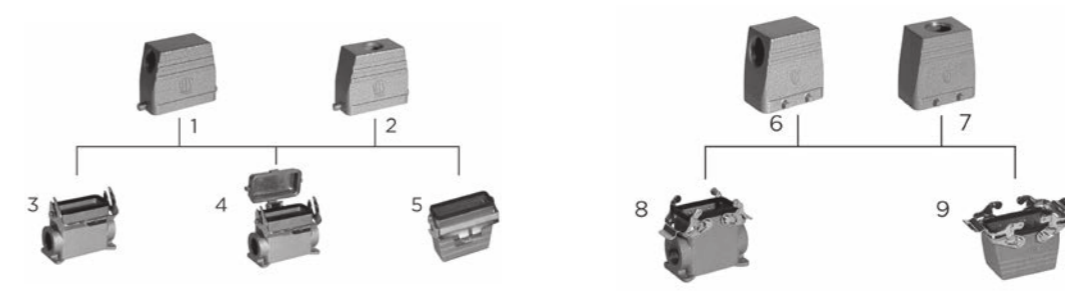

No.	Description	Thread type	Degree of protection	Width [mm]	Length [mm]	Height [mm]	Part number
1	Side cable entry - longitudinal clip	M32	65	43.0	93.5	76.0	1106452-5
2	Top cable entry - longitudinal clip	M32	65	43.0	93.5	76.0	1106452-2
3	Angled surface mounted housing - longitudinal clip	2 x M32	65	57.0	117.0	76.5	1106451-3
4	Angled surface mounted housing - Longitudinal clip with cover	2 x M32	65	57.0	117.0	76.5	1106451-2
5	Coupler housing - longitudinal clip	M32	65	43.0	93.5	79.5	1106450-1
6	Side cable entry - locking clip	M32	65	43.0	93.5	76.0	1106452-4
7	Top cable entry - locking clip	M32	65	43.0	93.5	76.0	1106452-1
8	Angled surface mounted housing - locking clip	M32	65	57.0	117.0	76.5	1103082-1
9	Coupler housing - locking clip	M32	65	57.0	93.5	79.5	1106450-2

## Contact inserts size 6

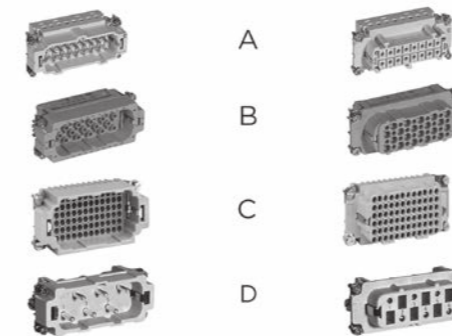

No.	Description	Positions	Current rating [A]	Voltage rating [V]	Type of connection	Part number
A	Pin insert	16 + PE	16	400	Screw	1-1103638-1
A	Socket insert	16 + PE	16	400	Screw	1-1103639-1
A	Pin insert without contacts	16 + PE	16	400	HE/HA crimp contacts	2-1103638-3
A	Socket insert without contacts	16 + PE	16	400	HE/HA crimp contacts	2-1103639-3
A	Pin insert	16 + PE	16	400	Cage clamp termination	7-1103638-1
A	Socket insert	16 + PE	16	400	Cage clamp termination	7-1103639-1
B	Pin insert without contacts	40 + PE	10	250	HN.D crimp contacts	2-1103110-3
B	Socket insert without contacts	40 + PE	10	250	HN.D crimp contacts	2-1103111-3
C	Pin insert without contacts	72 + PE	10	250	HN.D crimp contacts	2-1103208-3
C	Socket insert without contacts	72 + PE	10	250	HN.D crimp contacts	2-1103212-3
D	Pin insert	6 + PE	35	400	Screw	1-1104204-1
D	Socket insert	6 + PE	35	400	Screw	1-1104205-1

## Housing size 8 - high type with enlarged wiring space

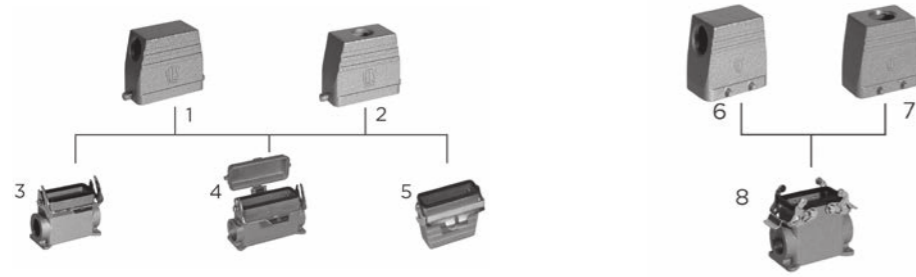

No.	Description	Thread type	Degree of protection	Width [mm]	Length [mm]	Height [mm]	Part number
1	Side cable entry - longitudinal clip	M32	65	43.0	120.0	78.0	1106470-5
2	Top cable entry - longitudinal clip	M32	65	43.0	120.0	78.0	1106470-2
3	Angled surface mounted housing - longitudinal clip	2 x M32	65	57.0	144.0	78.5	1106469-3
4	Angled surface mounted housing - longitudinal clip with cover	2 x M32	65	57.0	144.0	78.5	1106469-2
5	Coupler housing - longitudinal clip	M32	65	42.8	120.0	81.5	1106468-1
6	Side cable entry - locking clip	M40	65	43.0	120.0	78.0	1-1106470-9
7	Top cable entry - locking clip	M40	65	43.0	120.0	78.0	3-1106470-0
8	Coupler housing - locking clip	M32	65	57.0	144.0	78.5	1103083-1

## Contact inserts size 8

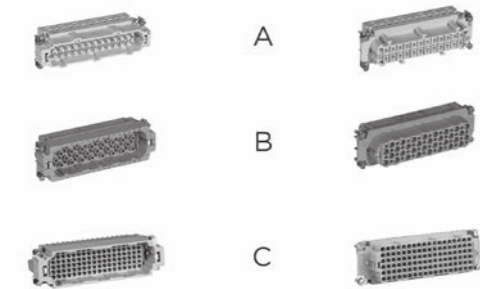

No.	Description	Positions	Current rating [A]	Voltage rating [V]	Type of connection	Part number
A	Pin insert	24 + PE	16	400	Screw	1-1103640-1
A	Socket insert	24 + PE	16	400	Screw	1-1103641-1
A	Pin insert without contacts	24 + PE	16	400	HE/HA crimp contacts	2-1103640-3
A	Socket insert without contacts	24 + PE	16	400	HE/HA crimp contacts	2-1103641-3
A	Pin insert	24 + PE	16	400	Cage clamp termination	7-1103640-1
A	Socket insert	24 + PE	16	400	Cage clamp termination	7-1103641-1
B	Pin insert without contacts	64 + PE	10	250	HN.D crimp contacts	2-1103112-3
B	Socket insert without contacts	64 + PE	10	250	HN.D crimp contacts	2-1103113-3
C	Pin insert without contacts	108 + PE	10	250	HN.D crimp contacts	2-1103216-3
C	Socket insert without contacts	108 + PE	10	250	HN.D crimp contacts	2-1103220-3

## Crimp contact series HN.D

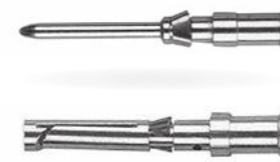

Contact surface	Wire size [mm <sup>2</sup> ]	Part number	
		Pin contact	Socket contact
Silver-plated	0.14-0.37	1-1105050-1	1-1105051-1
Silver-plated	0.50	2-1105050-1	2-1105051-1
Silver-plated	0.75-1.00	3-1105050-1	3-1105051-1
Silver-plated	1.50	4-1105050-1	4-1105051-1
Silver-plated	2.50	5-1105050-1	5-1105051-1



Contact surface	Wire size [mm <sup>2</sup> ]	Part number	
		Pin contact	Socket contact
Silver-plated	0.50	1-1105100-1	1-1105101-1
Silver-plated	0.75-1.00	2-1105100-1	2-1105101-1
Silver-plated	1.50	3-1105100-1	3-1105101-1
Silver-plated	2.50	4-1105100-1	4-1105101-1
Silver-plated	4.00	5-1105100-1	5-1105101-1



## Metal gland fitting



Size	Cable diameter min. - max. [mm]	SW	Article. No.
M16	4-8	22	1-1102771-6
M20	6-12	24	2-1102771-0
M25	10-14	29	2-1102771-5
M32	13-18	36	3-1102771-2
M40	18-25	46	4-1102771-0

Size	Cable diameter min. - max. [mm]	SW	Article. No.
M16	5 - 10	17	1-1102770-6
M20	6 - 12	22	2-1102770-0
M25	13 - 18	27	2-1102770-5
M32	18 - 25	34	3-1102770-2
M40	22 - 32	43	4-1102770-0

## Tools



Description	Part number
Crimping tool for HN.D and HA/HE contacts	1-1105851-8
Insertion tool for small diameters	1102855-6
Extraction tool for HN.D contacts	1102855-2
Extraction tool for HE/HA contacts	1102855-7

## Crompton Instruments

## Product overview



## INTEGRA MULTIFUNCTION METERS

- A wide range of highly accurate Integra multifunction meters that measure up to 100 electrical parameters. The measured values can be transferred to energy and building management systems via different integrated or optional interfaces or pulse outputs. Available are panel mounting versions with ANSI or DIN dimensions, suitable for DIN rail mounting, with LCD or LED display.



## INTEGRA AND PALADIN TRANSDUCERS

- A wide range of different transducers for the measurement, isolation and conversion of electrical parameters into standard measurement signals. These transducers are available with single or multiple outputs depending on the model.



## ENERGY METERS

- Energy meters for DIN rail mounting (now with MID approval) and panel mounting for the measurement of kWh and kVARh with different output and communication options for a wide range of energy measurements.



## PROTECTOR TRIP RELAYS

- Protector trip relays provide continuous control and protection of one or more electrical parameters in electrical installations. Suitable for single or three-phase power systems depending on the model.



## ANALOGUE INSTRUMENTS

- These «classic» instruments for power installations are available in standardised DIN and ANSI styles. These instruments are sealed and protected against impacts and shocks for use in harsh mechanical environments. All instruments are available in a range of styles, sizes and performance specifications.



## LOW-VOLTAGE CURRENT TRANSFORMERS

- A complete range of low-voltage current transformers with standardised secondary current of 5 A or 1 A available as closed types, with moulded case or tape wound, single or three position or with split cores.



## DIGITAL METERS AND INDICATORS

- Digital meters and indicators monitor and display electrical parameters. In addition to analogue and digital meters, the latter also available as bargraph indicators, digital indicators are also available.

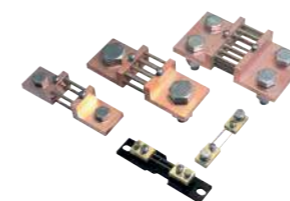

## SHUNTS

- Shunts provide an accurate voltage signal, exactly proportional to the system current and are therefore ideal for DC applications. Shunts in different sizes conforming to DIN are also available in a wide input current and voltage signal bandwidth.

**Integra Ci1 energy meters**

- Displays the real consumption of active and reactive energy
- 8-digit LCD display
- DIN panel mount, 96 mm x 96 mm, degree of protection IP52 (IP54 with additional seal)
- Configurable functions (electrical system, current transformer ratio, outputs)
- Accuracy class 1 according to IEC 62053-21
- Input values:  
100-290 V AC L/N (173-500 V AC L/L) - 5 A - 44/66 Hz (continuous overload 120%)
- Mains voltage:  
110-400 V AC +/-10%/120-350 V DC +/- 20 %
- Conforms to standards  
IEC 61326/IEC 61010-1/IEC 62053-21
- Optional: 1-2 pulse outputs or 1 RS485 Modbus RTU interface (then max. 1 pulse output)



Description	Part number
Integra Ci1 energy meters	CI1-01
Plug-in module pulse output	CI-PUL-01
RTU plug-in module RS485 Modbus	CI-MOD-01
Front cover IP65	3G36502
Additional seal IP54	3C34501

**Integra Ci3 multifunction meter**

- Display: U L/N, U L/L, f, %THD U L/N, %THD U L/L, I L1-L3, In, I L1-L3 max-dmd, In max-dmd, %THD I L1-L3, P, Q, S, P max-dmd, cos-phi, kWh, kVarh
- High contrast LCD display
- DIN panel mount, 96 mm x 96 mm, degree of protection IP52 (IP54 with additional seal)
- Configurable functions (electrical system, current transformer ratio, outputs)
- Accuracy: 0.5% (U & I)/1% (P, Q, S, kWh, kVarh) according to IEC 62053-21
- Mains voltage:  
110-400 V AC +/-10%/120-350 V DC +/- 20 %
- Conforms to standards  
IEC 61326/IEC 61010-1/IEC 62053-21
- Optional: 1-2 pulse outputs or 1 RS485 Modbus RTU interface (then max. 1 pulse output)



Description	Part number
Integra Ci3 multifunction meter	CI3-01
Plug-in module pulse output	CI-PUL-01
RTU plug-in module RS485 Modbus	CI-MOD-01
Front cover IP65	3G36502
Additional seal IP54	3C34501

**Integra Ri3 multifunction meter**

- Display: U L/N, U L/L, f, %THD U L/N, %THD U L/L, I L1-L3, In, I L1-L3 max-dmd, In, I L1-L3 max-dmd, %THD I L1-L3, P, Q, S, P max-dmd, cos-phi, +/- kWh, +/- kVarh
- High contrast LCD display
- DIN rail mounting
- Configurable functions (electrical system, current transformer ratio, outputs)
- Accuracy: 0.5% (U & I)/1% (P, Q, S, kWh, kVarh) according to IEC 62053-21
- Mains voltage:  
110-400 V AC +/-10%/120-350 V DC +/- 20 %
- Conforms to standards  
IEC 61326/IEC 61010-1/IEC 62053-21
- Features: 1 pulse output, 1 RS485 Modbus RTU interface



Description	Part number
Integra Ri3 multifunction meter	RI3-01

**Ebony and M3N1 series low-voltage current transformers**

- Single position bus type current transformer for conductors and busbars, single position current transformer with primary terminal
- Three position current transformer for conductors and busbars
- Summation current transformer
- Halogen-free, impact resistant polycarbonate case with excellent insulation properties
- Ratio rating from 1/5 A to 6000/5 A (x/1 on request)
- Connection via box terminal or flat push-on connection
- Maximum voltage 720 V (test voltage 3 kV for 1 min) 50-60 Hz
- Including foot and busbar mounting (DIN rail mounting available as accessory)
- Ith: 60 x In (1s)
- Overload withstand: 1.2 x In
- Degree of protection: IP40 (case) - IP20 (terminals)
- Standards: EN 61010-1/EN 60044-1. UL approval: E257877

Type	Type	Dimensions W x D x H [mm]	Internal dimension [mm]	Available ratios	Output
MA5Y	Primary connection	77 x 50 x 116	M8 connection bolt	1-5-10-15-20-30-40/5 A	5 to 7.5 VA
M55E	Rail/circular conductor	50 x 50 x 80	15 x 5 and Ø 16	30-40-50-60-75-80-100/5 A	1.25 to 7.5 VA
M53Q	Rail/circular conductor	45 x 30 x 65	20 x 6 und Ø 21	50-60-75-80-100-125-150-200-250-300/5 A	1.25 to 7.5 VA
M65F	Rail/circular conductor	60 x 50 x 94	20 x 10 and Ø 23	30-40-50-60-75-80-100-125-150-200-250-300/5 A	2.5 to 30 VA
M53J	Rail/circular conductor	50 x 30 x 80	30 x 10-25 x 15-20 x 20 and Ø 25	100-125-150-160-200-250-300-400/5 A	1.25 to 7.5 VA
M63N	Rail/circular conductor	60 x 30 x 94	40 x 10 and Ø 32	200-250-300-400-500-600-750-800/5 A	2.5 to 15 VA
MA5G	Rail/circular conductor	77 x 50 x 116	40 x 10-30 x 30 and Ø 36	100-125-150-200-250-300-400-500-600-750-800-1000/5 A	2.5 to 20 VA
M93L	Rail/circular conductor	90 x 30 x 131	50 x 10-40 x 30 and Ø 36	400-500-600-750-800-1000-1250-1500-1600/5 A	3.75 to 30 VA
M93R	Rail/circular conductor	90 x 30 x 131	64 x 12.6-60 x 30	800-1000-1200-1250-1500-1600-2000/5 A	5 to 30 VA
M93S	Rail/circular conductor	90 x 30 x 131	76.5 x 19-60 x 30	800-1000-1200-1250-1500-1600-2000/5 A	5 to 30 VA
MB5D	Rail/circular conductor	134 x 50 x 156	80 x 30-60 x 30-50 x 50 and Ø 63	400-500-600-750-800-1000-1200-1250-1500-1600-2000/5 A	5 to 50 VA
MB5Z	Rail/circular conductor	134 x 50 x 156	104 x 35 and Ø 35	750-800-1000-1200-1250-1500-1600-2000-2400-2500-3000-4000/5 A	2.5 to 30 VA
MC5T	Rail/circular conductor	140 x 50 x 238	160 x 50	1600-2000-2500-3000-3200-4000-5000-6000/5 A	20 to 60 VA
MD5T	Rail/circular conductor	213 x 50 x 165	160 x 50	1600-2000-2500-3000-4000-5000-6000/5 A	20 to 60 VA
S95P	Summation current transformer	90 x 50 x 144	-	5+5=5 and 5+5+5=5	5 VA
S97P	Summation current transformer	90 x 70 x 144	-	5+5+5=5 and 5+5+5+5=5 and 5+5+5+5+5=5	5 VA
M3N1-25	Three position	60 x 76.5 x 80	3 x 14.5/24.5 pole centre 25 mm	60-100-125-150-160/5 A	1 to 2.5 VA
M3N1-35	Three position	38 x 105 x 80	3 x 20.5/24.5 pole centre 35 mm	100-125-150-160-200-250/5 A	1.5 to 2.5 VA
M3N1-45	Three position	38 x 141 x 95	3 x 30.5/30.5 pole centre 45 mm	250-300-400-500-600-630/5 A	1.5 to 3.75 VA

Further details can be found in our brochure EPP-DE core range 12/2011  
[http://crompton-instruments.com/index\\_de.html](http://crompton-instruments.com/index_de.html)

## About TE Connectivity

TE Connectivity (NYSE: TEL) is a \$13 billion world leader in connectivity. The company designs and manufactures products at the heart of electronic connections for the world's leading industries including automotive, energy and industrial, broadband communications, consumer devices, healthcare, and aerospace and defense. TE Connectivity's long-standing commitment to innovation and engineering excellence helps its customers solve the need for more energy efficiency, always-on communications and ever-increasing productivity. With nearly 90,000 employees in over 50 countries, TE Connectivity makes connections the world relies on to work flawlessly every day.

To connect with the company, visit: [www.te.com](http://www.te.com)

While TE has made every reasonable effort to ensure the accuracy of the information in this catalogue, TE does not guarantee that it is error-free, nor does TE make any other representation, warranty or guarantee that the information is accurate, correct, reliable or current. TE reserves the right to make any adjustments to the information contained herein at any time without notice. TE expressly disclaims all implied warranties regarding the information contained herein, including, but not limited to, any implied warranties of merchantability or fitness for a particular purpose. The dimensions in this catalogue are for reference purposes only and are subject to change without notice. Specifications are subject to change without notice. Consult TE for the latest dimensions and design specifications. TE Connectivity, TE connectivity (logo) AMPLIMITE, ELECTRO-TAP, LIGHT-N-LOK, MATE-N-LOK, PIDG, PLASTI-GRIP, Raychem, ROTA-CRIMP, SOLARLOK, SOLISTRAND, SPIRAP, STRATO-THERM, SUPER CHAMP and VAL-U-LOK are trademarks. Other logos, product and company names mentioned herein may be trademarks of their respective owners.