



SAW Components

Data Sheet K 6264 K

Data Sheet

A large, stylized, 3D-rendered graphic of the EPCOS logo. The word "EPCOS" is written in a bold, sans-serif font, with the letters appearing to be part of a curved, metallic-looking structure. The background is dark and textured, suggesting a circuit board or a similar technical surface.

EPCOS



SAW Components

K 6264 K

IF Filter for Intercarrier/Multistandard Applications

38,00 MHz

Data Sheet

Standard

- D/K
- M/N

Features

- TV IF filter switchable from M/N mode to D/K mode
- M/N mode with Nyquist slope and sound shelf at 33,50 MHz
- Constant group delay
- D/K mode with Nyquist slope and broad sound shelf for sound carriers at 31,50 MHz and 32,50 MHz
- Group delay predistortion
- Suitable for CENELEC EN 55020

Plastic package **DIP10K**

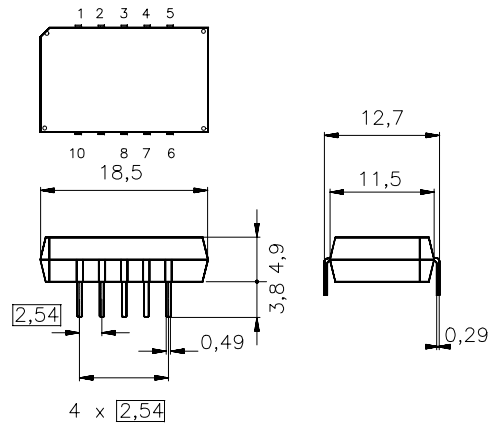

Dimensions in mm, approx. weight 1,8 g

Terminals

- Tinned CuFe alloy

Pin configuration

- 1 Input
- 2 Input - ground
- 3; 8 Chip carrier - ground
- 4; 5 Output
- 6; 7 Not connected
- 9 Free
- 10 Switching input

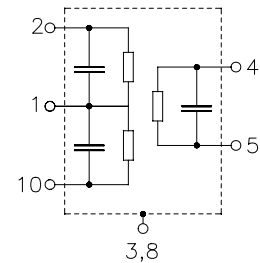

Type	Ordering code	Marking and package according to	Packing according to
K 6264 K	B39380-K6264-K100	C61157-A2-A3	F61074-V8068-Z000

Maximum ratings

Operable temperature range	T_A	-25/+65	°C	
Storage temperature range	T_{stg}	-40/+85	°C	
DC voltage	V_{DC}	12	V	between any terminals
AC voltage	V_{pp}	10	V	between any terminals



SAW Components

K 6264 K

IF Filter for Intercarrier/Multistandard Applications

38,00 MHz

Data Sheet

Characteristics in M/N mode (switching input pin 10 connected to input pin 1)

Reference temperature: $T_A = 25\text{ °C}$
 Terminating source impedance: $Z_S = 50\ \Omega$
 Terminating load impedance: $Z_L = 2\text{ k}\Omega \parallel 3\text{ pF}$

		min.	typ.	max.	
Insertion attenuation					
	α				
Reference level for the following data	36,50 MHz	13,7	15,2	16,7	dB
Relative attenuation					
	α_{rel}				
Picture carrier	38,00 MHz	5,2	6,2	7,2	dB
Color carrier	34,42 MHz	3,8	4,8	5,8	dB
Sound carrier	33,50 MHz	19,6	21,1	22,6	dB
Adjacent picture carrier	32,00 MHz	42,0	50,0	—	dB
Adjacent sound carrier	39,50 MHz	46,0	59,0	—	dB
Lower sidelobe	25,00 ... 32,00 MHz	40,0	47,0	—	dB
Upper sidelobe	39,50 ... 45,00 MHz	40,0	48,0	—	dB
Reflected wave signal suppression					
1,2 μ s ... 6,0 μ s after main pulse (test pulse 250 ns, carrier frequency 36,50 MHz)		41,0	48,0	—	dB
Feedthrough signal suppression					
1,2 μ s ... 1,1 μ s before main pulse (test pulse 250 ns, carrier frequency 36,50 MHz)		—	56,0	—	dB
Group delay ripple (p-p)					
	$\Delta\tau$	—	40	—	ns
Impedance at 36,50 MHz					
Input:	$Z_{IN} = R_{IN} \parallel C_{IN}$	—	1,1 \parallel 20,9	—	k Ω \parallel pF
Output:	$Z_{OUT} = R_{OUT} \parallel C_{OUT}$	—	1,5 \parallel 5,8	—	k Ω \parallel pF
Temperature coefficient of frequency					
	TC_f	—	-72	—	ppm/K

SAW Components
K 6264 K
IF Filter for Intercarrier/Multistandard Applications
38,00 MHz
Data Sheet
Characteristics in D/K mode (switching input pin 10 connected to ground input pin 2)

Reference temperature: $T_A = 25\text{ °C}$
 Terminating source impedance: $Z_S = 50\ \Omega$
 Terminating load impedance: $Z_L = 2\text{ k}\Omega \parallel 3\text{ pF}$

		min.	typ.	max.	
Insertion attenuation					
	α				
Reference level for the following data	36,50 MHz	13,8	15,3	16,8	dB
Relative attenuation					
	α_{rel}				
Picture carrier	38,00 MHz	5,0	6,0	7,0	dB
Color carrier	33,57 MHz	1,2	2,2	3,2	dB
Sound carrier	31,50 MHz	18,2	19,7	21,2	dB
	32,50 MHz	17,7	19,2	—	dB
Adjacent picture carrier	30,00 MHz	43,0	51,0	—	dB
Adjacent sound carrier	39,50 MHz	44,0	55,0	—	dB
Lower sidelobe	25,00 ... 30,00 MHz	40,0	46,0	—	dB
Upper sidelobe	39,50 ... 45,00 MHz	38,0	45,0	—	dB
Reflected wave signal suppression					
1,2 μ s ... 6,0 μ s after main pulse (test pulse 250 ns, carrier frequency 36,50 MHz)		41,0	48,0	—	dB
Feedthrough signal suppression					
1,2 μ s ... 1,1 μ s before main pulse (test pulse 250 ns, carrier frequency 36,50 MHz)		—	56,0	—	dB
Group delay predistortion					
(reference frequency 38,00 MHz)					
	$\Delta\tau$				
	37,00 MHz	—	15	—	ns
	33,57 MHz	—	35	—	ns
Impedance at 36,50 MHz					
	Input: $Z_{IN} = R_{IN} \parallel C_{IN}$	—	0,8 \parallel 26,8	—	k Ω \parallel pF
	Output: $Z_{OUT} = R_{OUT} \parallel C_{OUT}$	—	1,5 \parallel 5,7	—	k Ω \parallel pF
Temperature coefficient of frequency					
	TC_f	—	-72	—	ppm/K



Data Sheet

Frequency response M/N mode (switching input pin 10 connected to input pin 1)

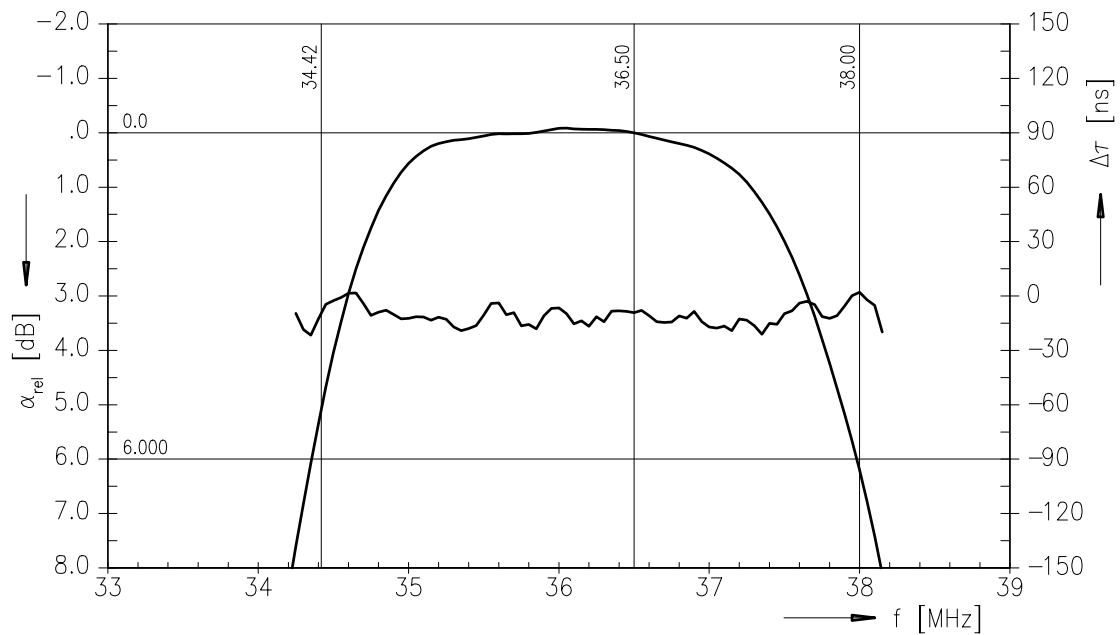
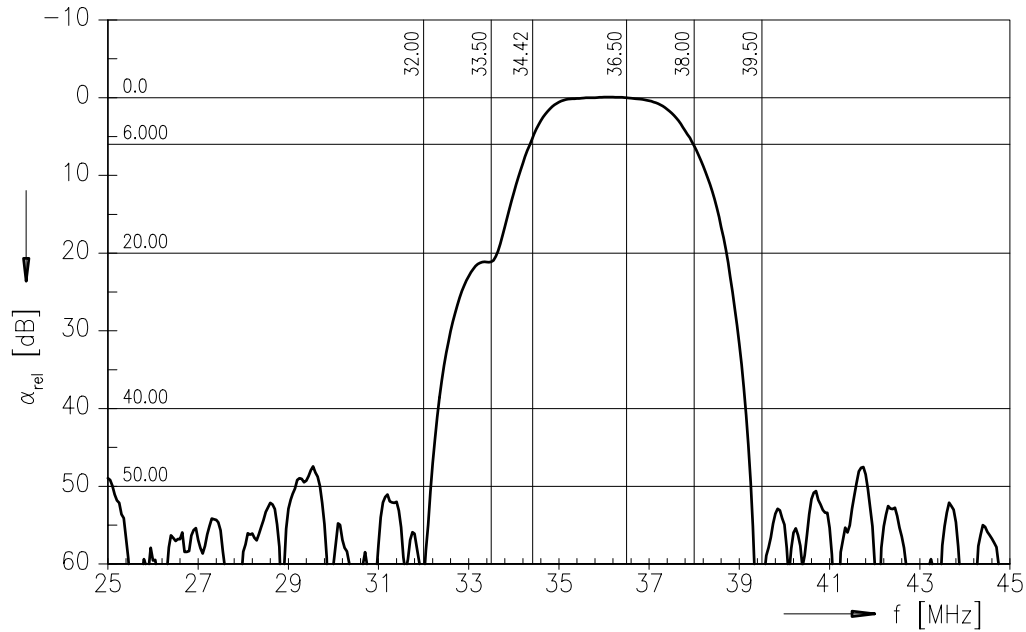



SAW Components

K 6264 K

IF Filter for Intercarrier/Multistandard Applications

38,00 MHz

Data Sheet

Frequency response M/N mode (switching input pin 10 connected to input pin 1)

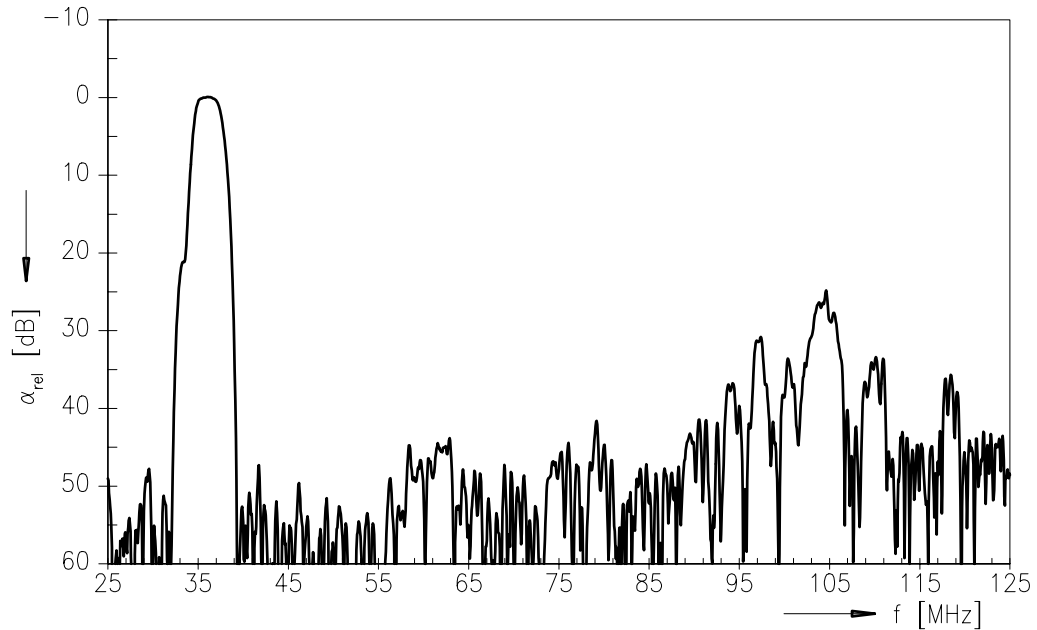

Time domain response M/N mode

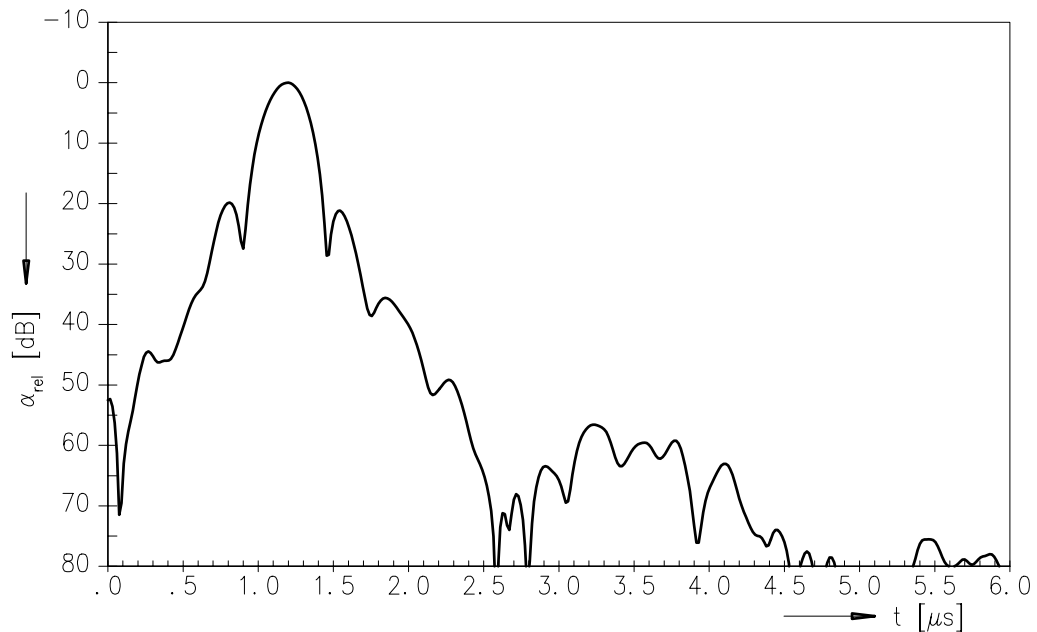



SAW Components

K 6264 K

IF Filter for Intercarrier/Multistandard Applications

38,00 MHz

Data Sheet

Frequency response D/K mode (switching input pin 10 connected to ground input pin 2)

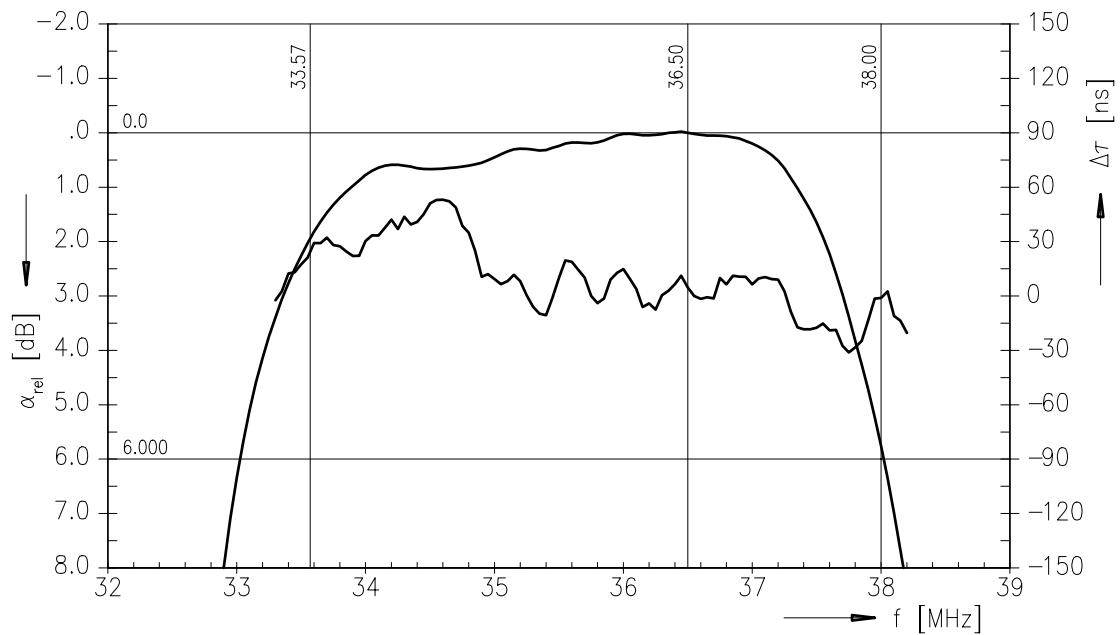
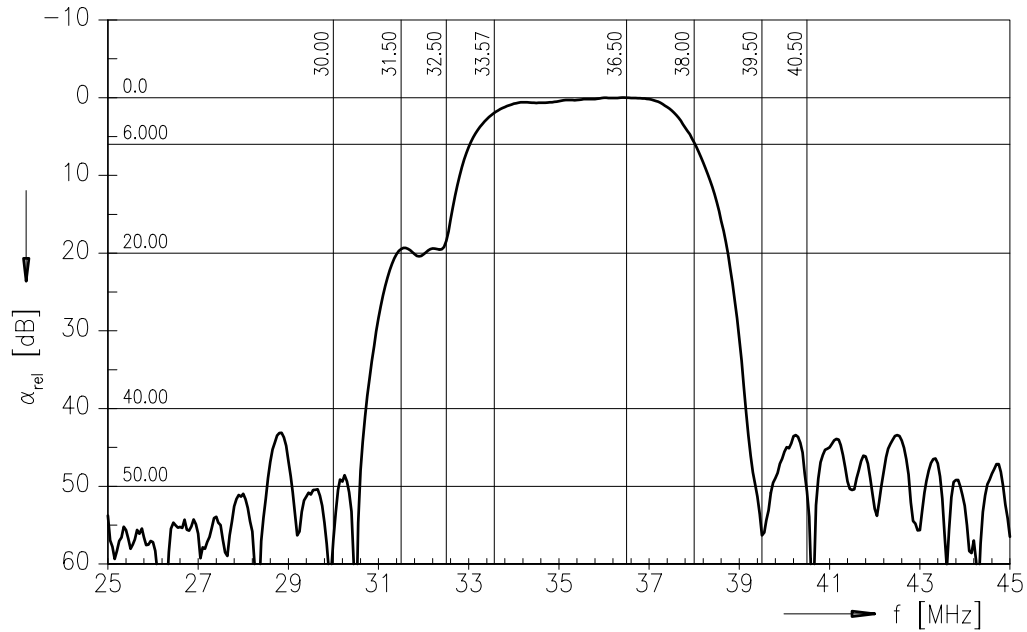



SAW Components

K 6264 K

IF Filter for Intercarrier/Multistandard Applications

38,00 MHz

Data Sheet

Frequency response D/K mode (switching input pin 10 connected to ground input pin 2)

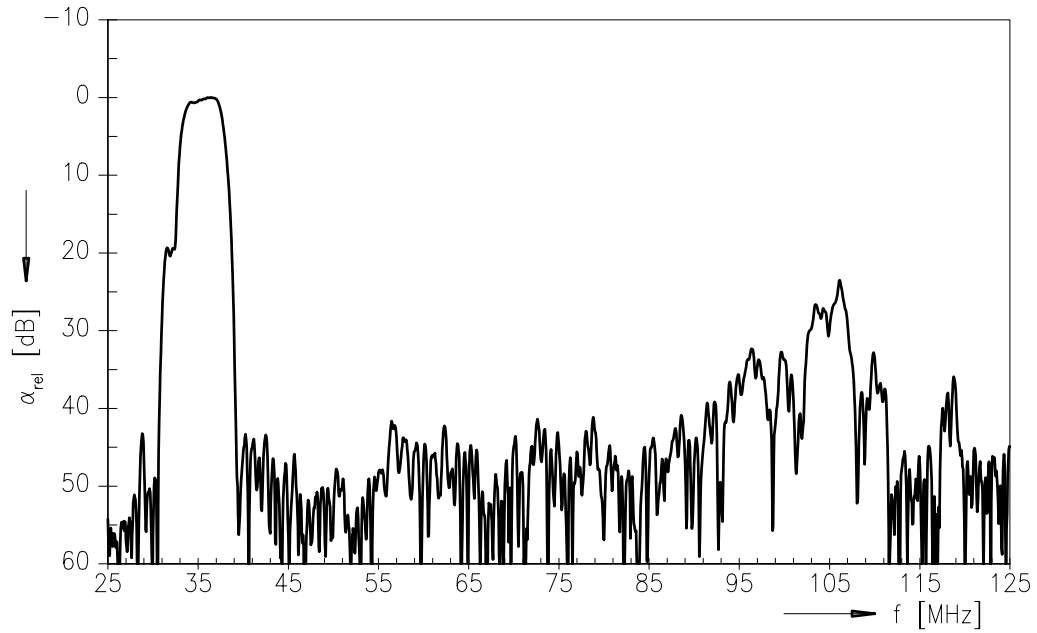

Time domain response D/K mode

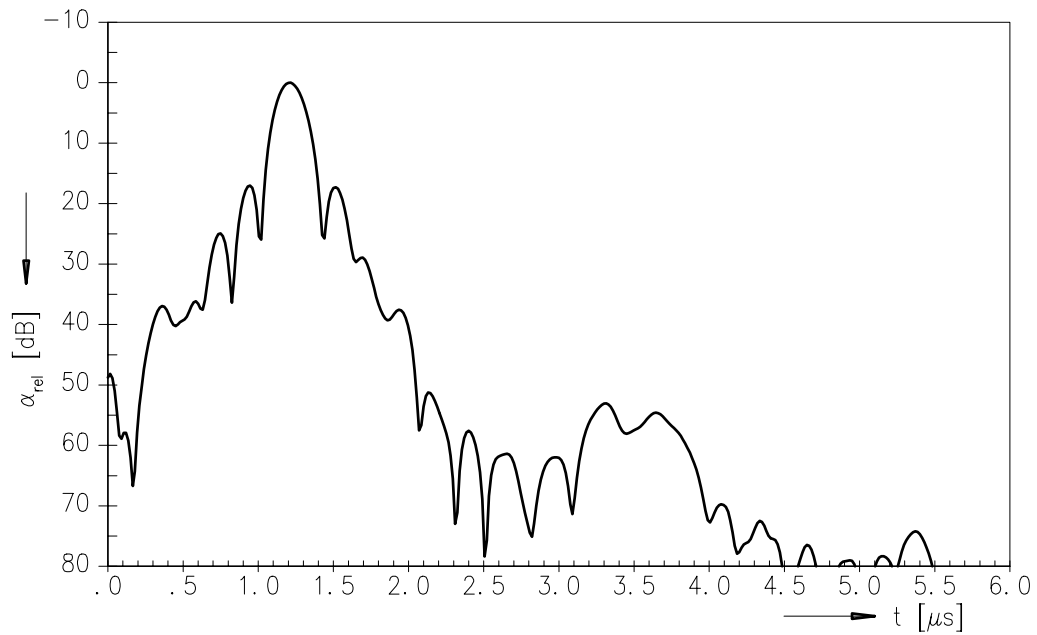



SAW Components

K 6264 K

IF Filter for Intercarrier/Multistandard Applications

38,00 MHz

Data Sheet

Published by EPCOS AG

Surface Acoustic Wave Components Division, SAW CE MM PD

P.O. Box 80 17 09, D-81617 München

© EPCOS AG 2001. All Rights Reserved.

As far as patents or other rights of third parties are concerned, liability is only assumed for components per se, not for applications, processes and circuits implemented within components or assemblies.

The information describes the type of component and shall not be considered as assured characteristics.

Terms of delivery and rights to change design reserved.

For questions on technology, prices and delivery please contact the sales offices of EPCOS AG or the international representatives.

Due to technical requirements components may contain dangerous substances. For information on the type in question please also contact one of our sales offices.