

## Features

Package	1608 size, Infrared emitting LED (Wavelength : 870nm) Drive current : 20mA
Product features	<ul style="list-style-type: none"> <li>• Outer Dimension 1.6 x 0.8 x 0.7mm( L x W x H )</li> <li>• Lead-free soldering compatible</li> <li>• RoHS compliant</li> </ul>

## Recommended Applications

- Infrared data communication, Home appliances, OA/FA, Other general data communication etc.

# Outline Dimensions

TDN1111C-TR

Unit : mm  
Weight : 1.4mg  
Tolerance : ±0.1

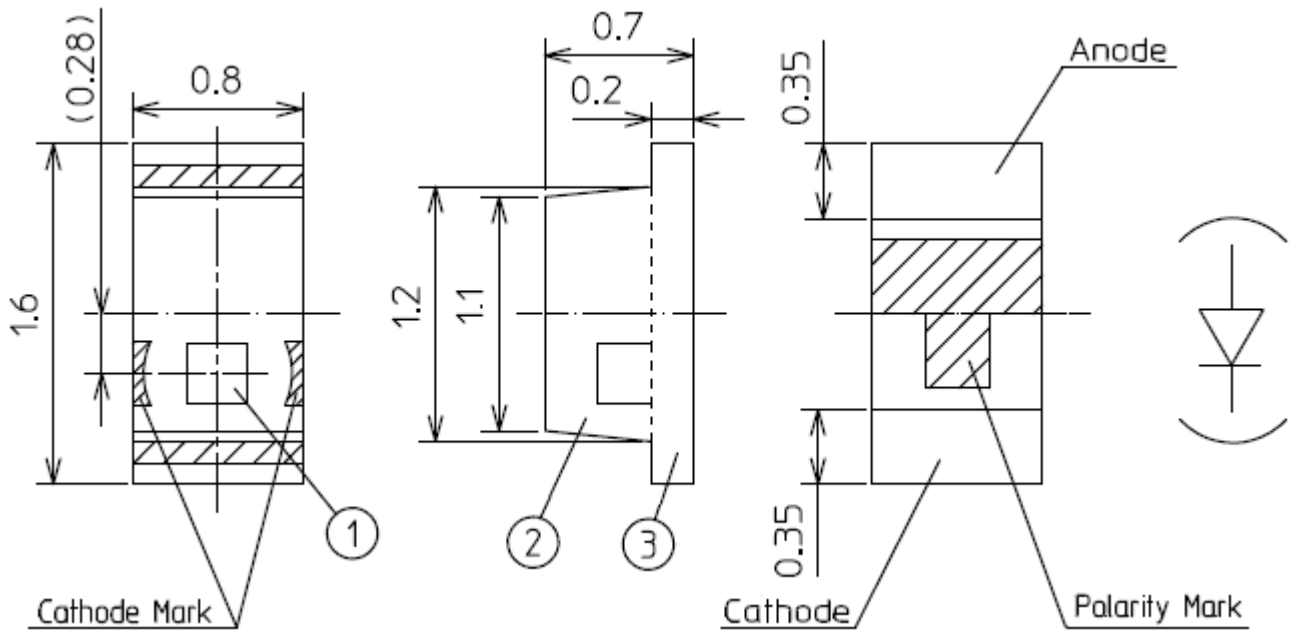

NO.	PART NAME	MATERIALS	QTY.
①	LED die	GaAlAs	1
②	Mold resin	Epoxy resin	1
③	Substrate	Glass fabrics	1

## Recommended Pad

Unit : mm

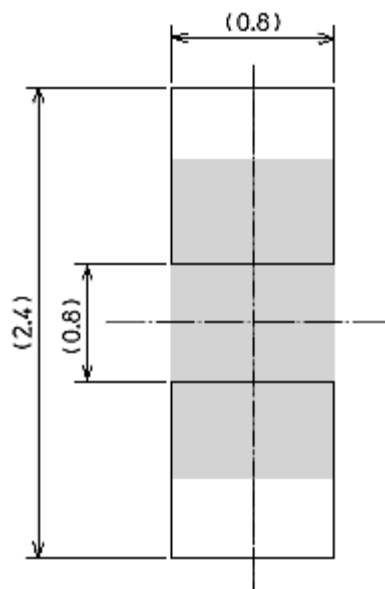

## 【 Absolute Maximum Ratings 】

(Ta=25°C)

ITEM	SYMBOL	MAXIMUM RATINGS	UNIT
Power dissipation	$P_d$	95	mW
Forward current	$I_F$	50	mA
Repetitive peak forward current "0.1ms,1/100duty"	$I_{FRM}$	300	mA
Forward current derating factor from 25°C	$\Delta I_F$	0.67	mA/°C
Repetitive peak forward current derating factor from 25°C	$\Delta I_{FRM}$	4	mA/°C
Reverse voltage	$V_R$	5	V
Operating temperature	$T_{opr}$	-30 ~ +85	°C
Storage temperature	$T_{stg}$	-40 ~ +100	°C
Soldering temperature "Reflow soldering"	$T_{sld}$	260	°C

Note1

Note1 Please refer to page 10, soldering Conditions.

## 【 Electro-Optical Characteristics 】

(Ta=25°C)

ITEM	SYMBOL	CONDITION	MIN.	TYP.	MAX.	UNIT
Forward voltage	$V_F$	$I_F = 20\text{mA}$	1.2	1.4	1.7	V
Reserve current	$I_R$	$V_R = 5\text{V}$	-	-	100	$\mu\text{A}$
Capacitance	$C_o$	$V=0\text{V}, f=1\text{MHz}$	-	55	-	pF
Radiant intensity	$I_E$	$I_F = 20\text{mA}$	1.0	-	2.8	mW/sr
Total power	$P_o$	$I_F = 20\text{mA}$	-	8.0	-	mW
Peak wavelength	$\lambda_p$	$I_F = 20\text{mA}$	850	870	890	nm
Spectral line half width	$\Delta \lambda$	$I_F = 20\text{mA}$	-	50	-	nm
Half intensity angle	$2\theta_{1/2}$	$I_F = 20\text{mA}$	-	125	-	deg.
Cut-off Frequency	$f_c$	$I_F = 20\text{mADC} + 10\text{mAp-p}$ -3db from 1MHz	-	50	-	MHz

## 【 Sorting Chart for Radiant Intensity 】

LEDs shall be sorted out into the following chart.

Radiant Intensity ( $I_E$ )
-----------------------------

Rank	Radiant intensity $I_E$ (mW/sr)		Conditions
	MIN.	MAX.	
A	1.0	2.0	$I_F = 20\text{mA}$ $T_a = 25^\circ\text{C}$
B	1.4	2.8	

## 【 Shipment 】

The each shipping lot shall consist of mixed rank (A, B) and the quantity of LEDs in each rank can not be specified.

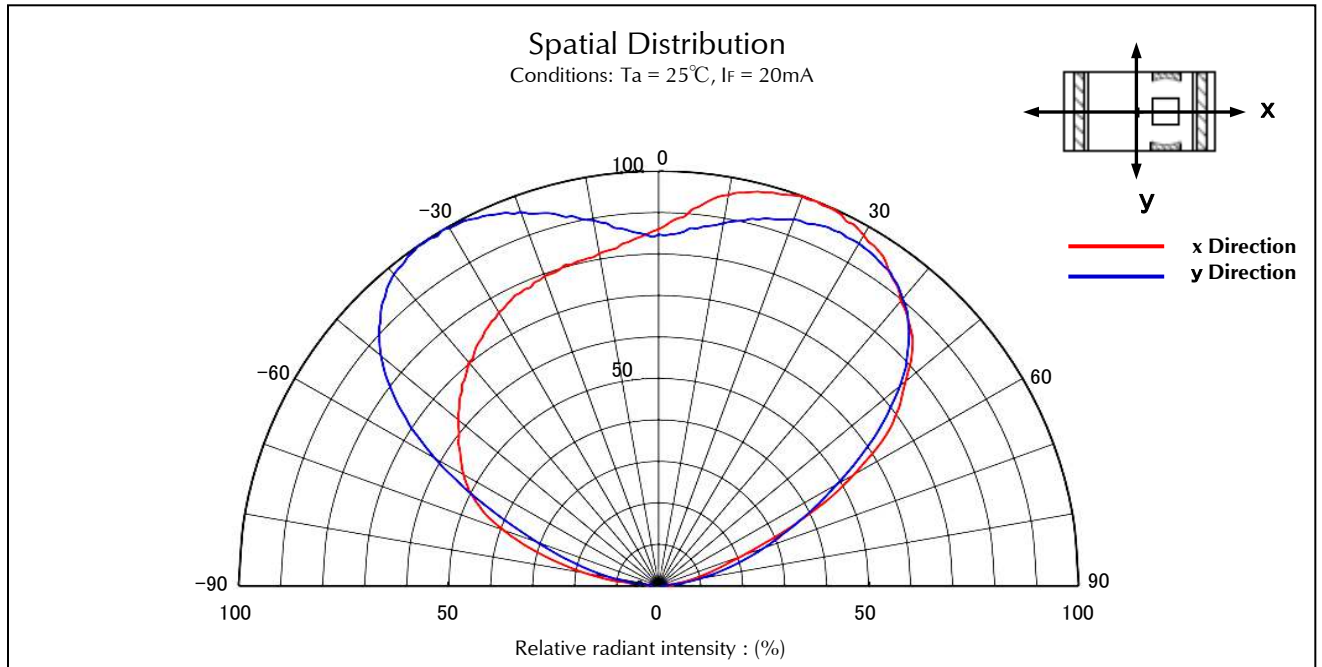
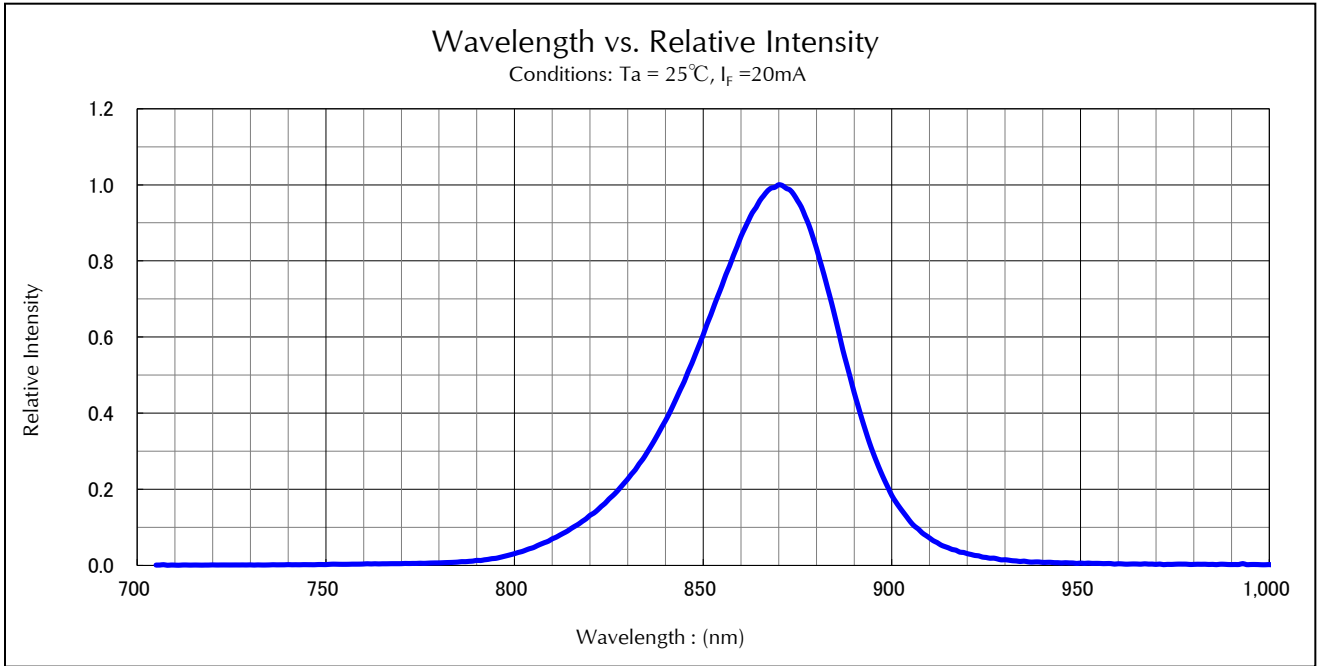

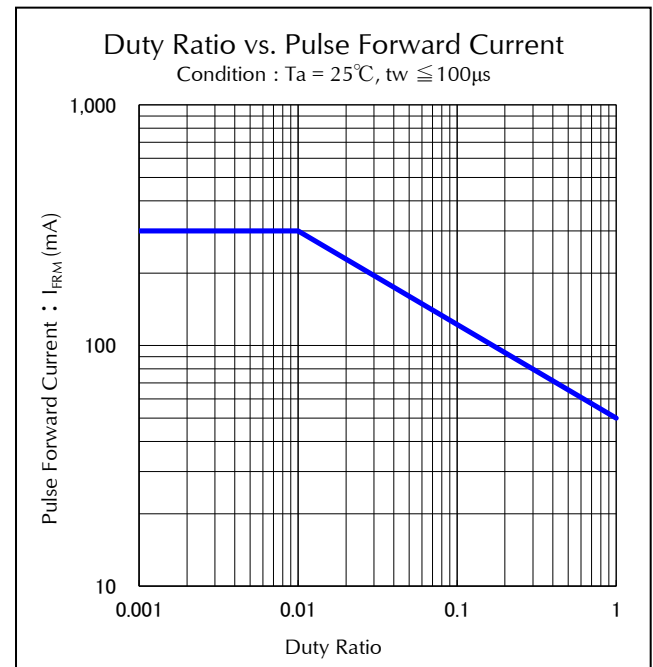
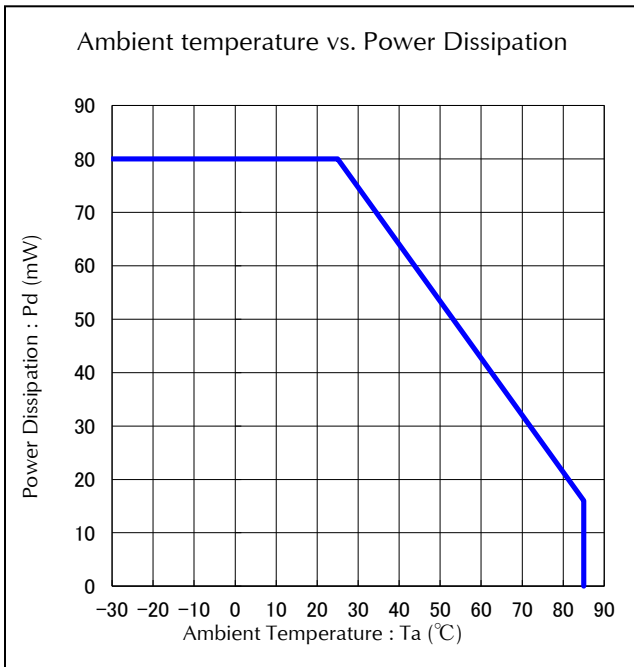
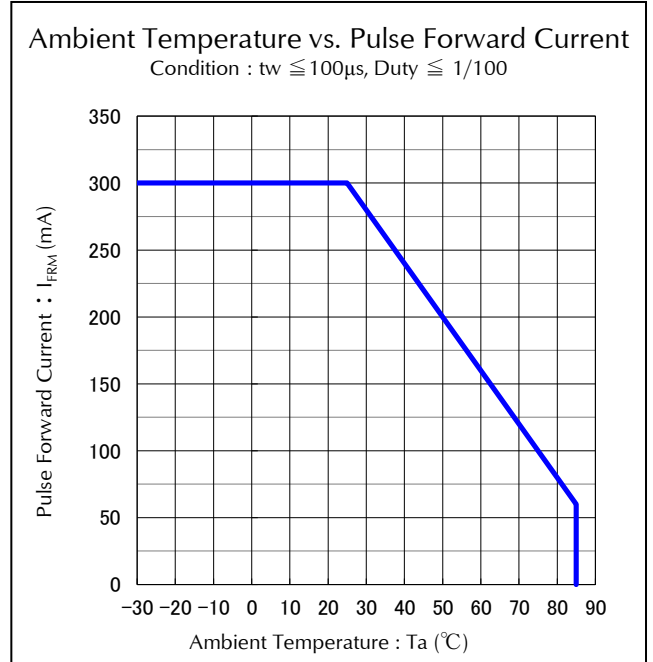
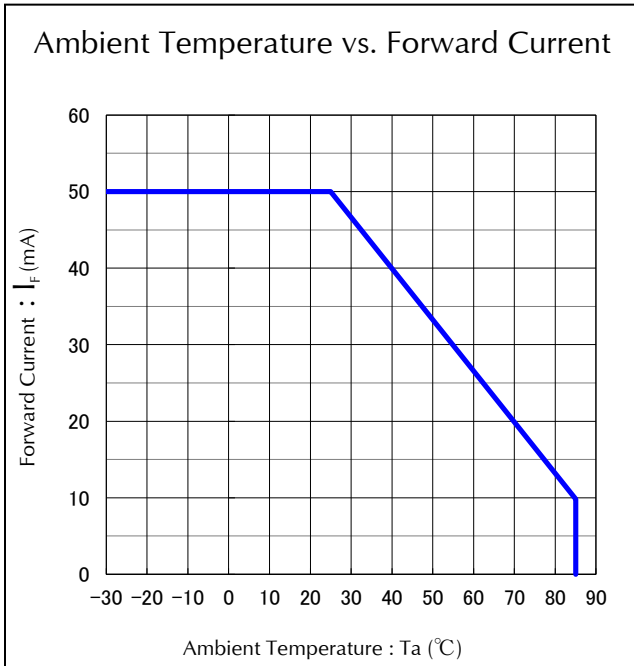

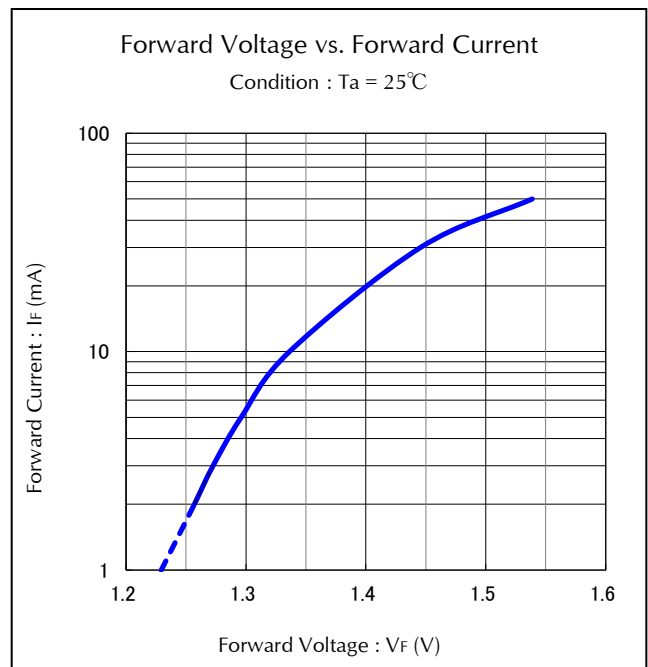
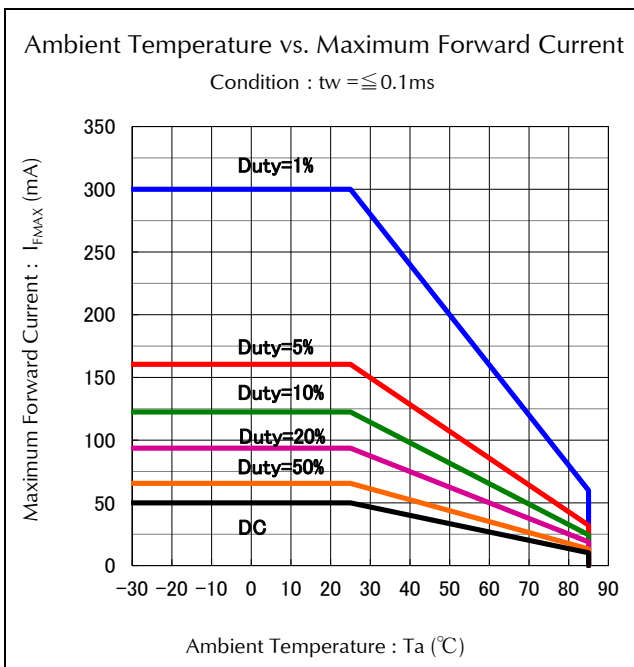
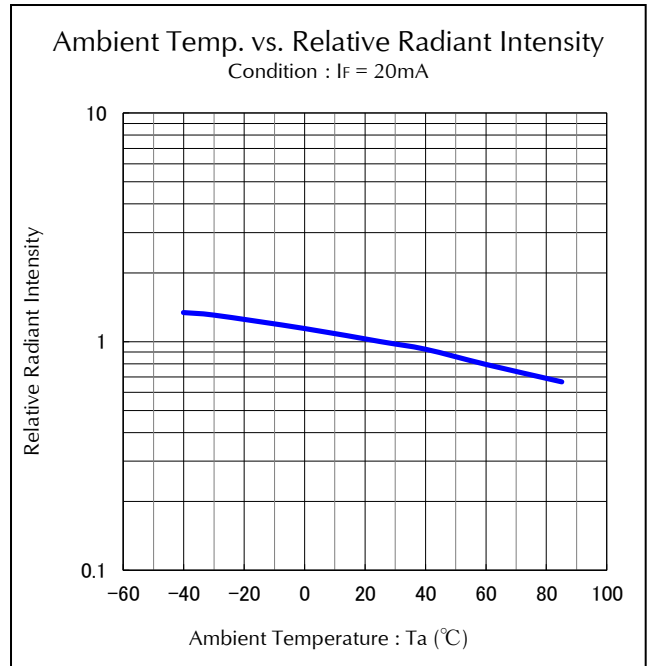
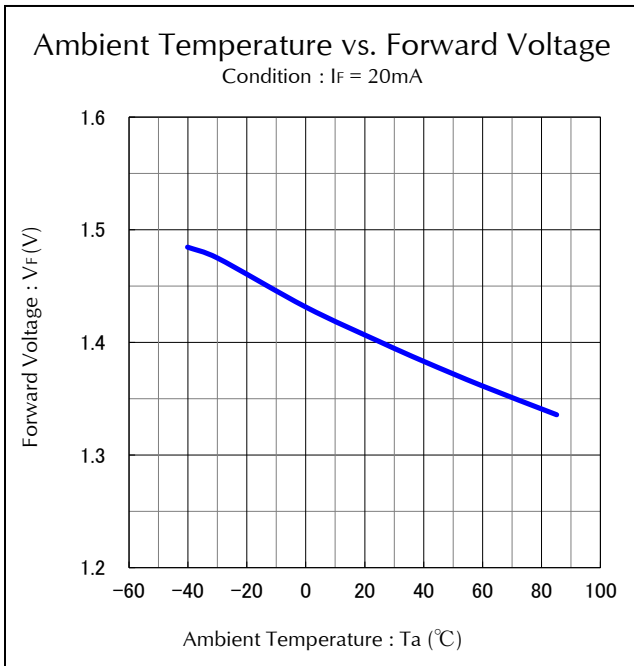

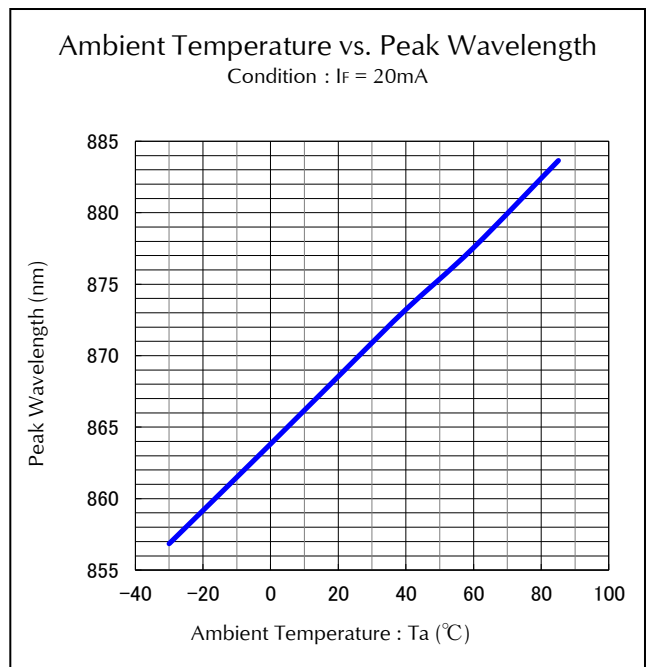
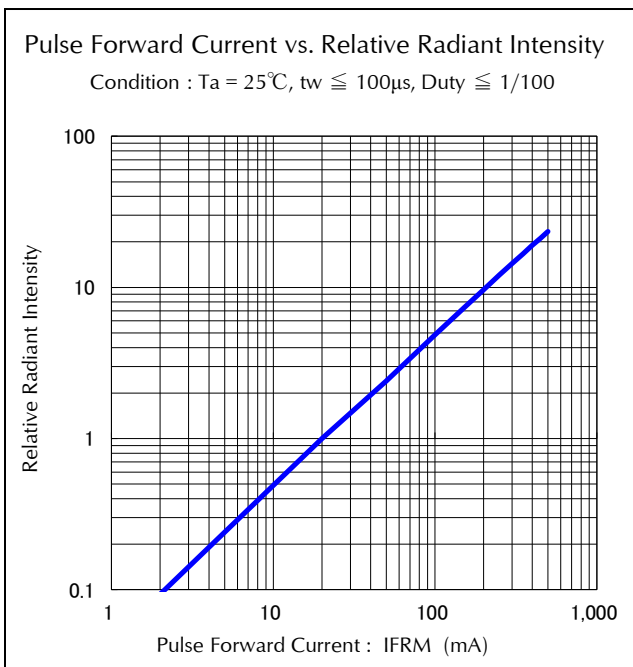
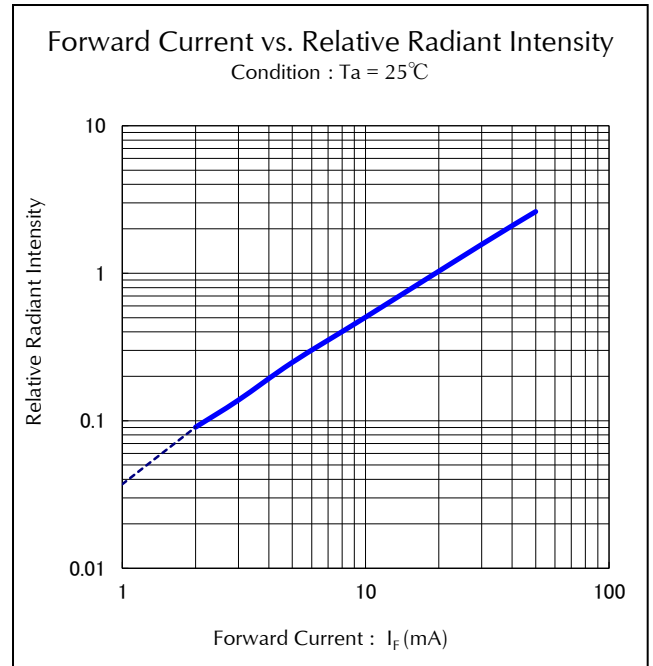
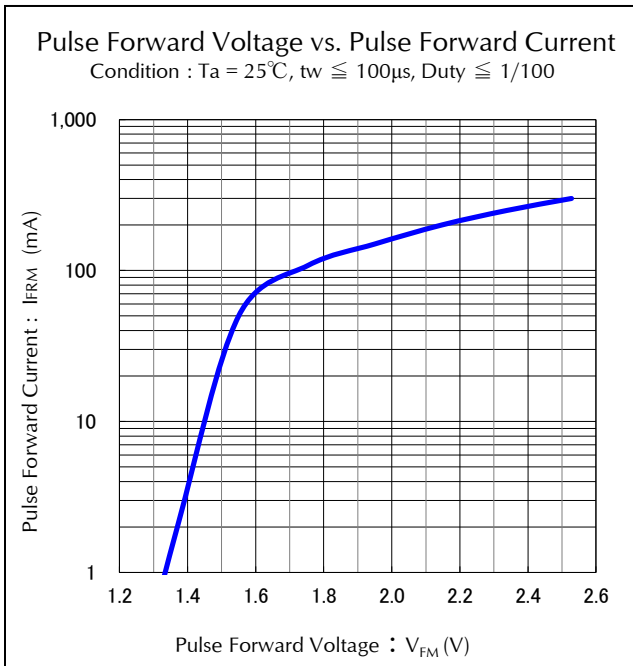



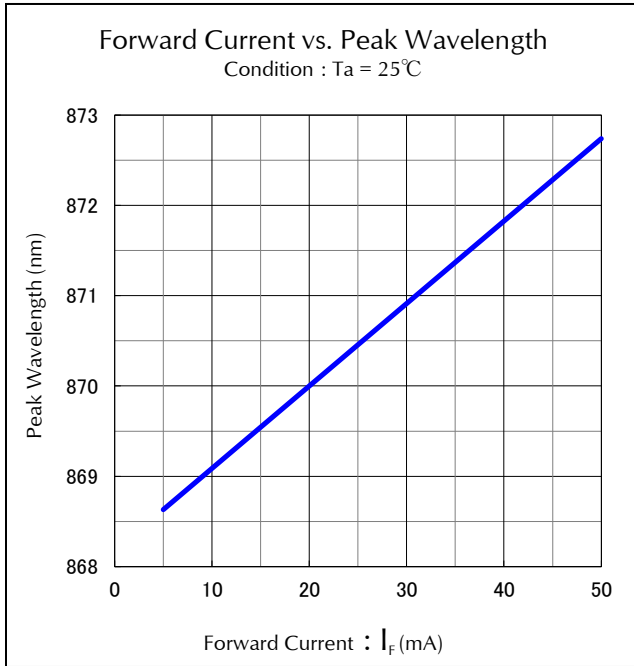

## 【Soldering Precaution】

(acc.to:EIAJ-4701/300)

1. Heat stress during soldering will influence the reliability of LEDs, however that effect will vary on heating method. Also, if components of varying shape are soldered together, it is recommended to set the soldering pad temperature according to the component most vulnerable to heat (e.g., surface mount LED).
2. LED parts including the resin are not stable immediately after soldering ( when they are not at room temperature), any mechanical stress may cause damage to the product. Please avoid such stress after soldering, especially stacking of the boards which may cause the boards to warp and any other types of friction with hard materials.
3. Recommended temperature profile for the Reflow soldering is listed as the temperature of the resin surface. Temperature distribution varies on heating method, PCB material, other components in the assembly, and mounting density.  
Please do not repeat the heating process in Reflow process more than twice.

### 【Recommended Reflow Soldering Condition】

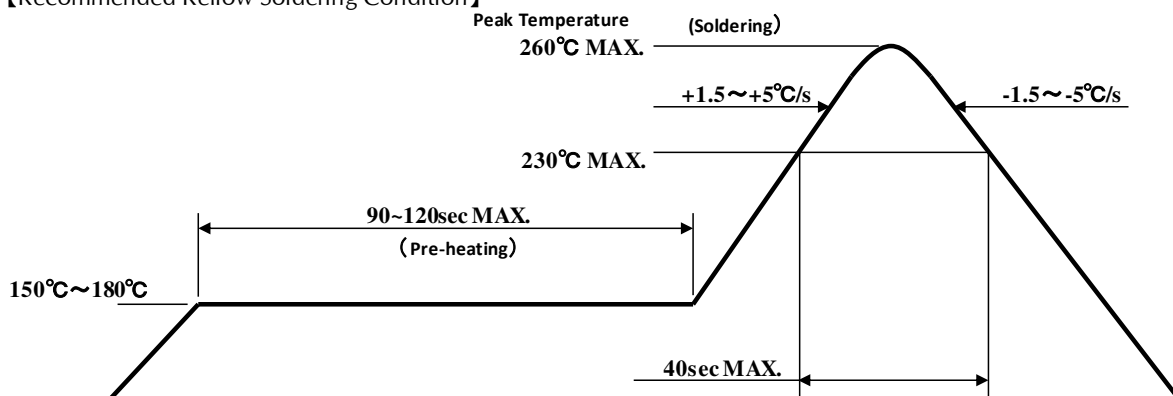

Notes 1 Temperature Profile for the reflow should be set to the surface temperature of resin which is on the top of LED. This should be the maximum temperature for soldering. Lowering the heating temperature and decreasing heating time is very effective in achieving higher reliability.

Notes 2 The reflow soldering process should be done up to twice(2 times Max). When second process is performed, interval between first and second process should be as short as possible to prevent absorption of moisture to resin of LED. The second soldering process should not be done until LEDs have returned to room temperature (by nature-cooling) after first soldering process.

4. If soldering manually, Stanley recommends using a soldering iron equipped with temperature control. During the actual soldering process, make sure that the soldering iron never touches the LED itself, and avoid the LED's electrode heating temperature reaching above the heating temperature of the solder pad. All repairs must be performed only once in the same spot, and please avoid reusing components.
5. In soldering process, immediately after iron tip is cleaned, please make sure that the soldering iron reaches the appropriate temperature before using. Also, please avoid applying any types of pressure to the soldered components before the solder has been cooled and hardened, as it may deteriorate solder performance and solder quality.

## 【Recommended Manual Soldering Condition】

Temperature of Iron Tip	350°C MAX.
Soldering Duration, Time	3sec. Max., 1 time

6. When using adhesive material for tentative fixatives, thermosetting resin or Ultraviolet radiation (UV) setting resin with heat shall be recommended.  
《The curing condition, Temperature:150°C Max./Time:120sec. Max.》
7. Flow soldering (dip soldering) is not recommended for this product.
8. Isopropyl alcohol is recommended for cleaning. Some chemicals, including Freon substitute detergent could corrode the lens or the casing surface, which cause discoloration, cloud, crack and so on. Please review the reference chart below for cleaning.  
If water is used to clean (including the final cleaning process), please use pure water (not tap water), and completely dry the component before using.  
Cleaning with ultrasonic is not recommended.

Chemical	Adaptability
Isopropyl Alcohol	○
Trichloroethylene	×
Chloroethene	×
Acetone	×
Thinner	×

## 【 Precautions 】

1. Stanley LED Lamps have semiconductor characteristics and are designed to ensure high reliability. However, the performance may vary depending on usage conditions
2. Absolute Maximum Ratings are set to prevent LED lamps from failing due to excess stress( temperature, current, voltage, etc.). Usage conditions must not exceed the ratings for a moment, nor do reach one item of absolute maximum ratings simultaneously.
3. In order to ensure high reliability from LED Lamps, variable factors that arise in actual usage conditions should be taken it to account for designing. ( Derating of TYP., MAX Forward Voltage, etc.)
4. Please insert Protective Resistors into the circuit in order to stabilize LED operation and to prevent the device from igniting due to excess current.
5. Please check the actual performance in the assembly because the Specification Sheets are described for LED device only.
6. Please refrain from looking directly at the light source of LED at high output, as it may harm your vision.
7. The products are designed to operate without failure in recommended usage conditions. However, please take the necessary precautions to prevent fire, injury, and other damages should any malfunction or failure arise.
8. The products are manufactured to be used for ordinary electronic equipment. Please contact our sales staff beforehand when exceptional quality and reliability are required, and the failure or malfunction of the products might directly jeopardize life or health ( such as for airplanes, aerospace, transport equipment, medical applications, nuclear reactor control systems and so on).
9. When there is a process of supersonic wave welding etc. after mounting the product, there is a possibility of affecting on the reliability of junction part in package (junction part of die bonding and wire bonding). Please make sure there is no problem before using.
10. The formal specification sheets shall be valid only by exchange of documents by both parties.

This product is baked (moisture removal) before packaging, and is shipped in moisture-proof packaging (as shown below) to minimize moisture absorption during transportation and storage. However, with regard to storing the products, Stanley recommends the use of dry-box under the following conditions is recommended. Moisture-proof bag as the packaging is made of anti-static material but packaging box is not.

## 【Recommended Storage Condition / Products Warranty Period】

Temperature	+5~30°C
Humidity	Under 70%

In the case of the package unopened , 6 months under 【 Recommended Storage Condition 】, Please avoid rapid transition from low temp. condition to high temp. condition and storage in corroding and dusty environment.

## 【Time elapsed after Package Opening】

The package should not be opened until immediately prior to its use, and please keep the time frame between package opening and soldering which is **【maximum 72h】**.  
If the device needs to be soldered twice, both soldering operations must be completed within 72h.

If any components should remain unused, please reseal the package and store them under the conditions described in the 【 Recommended Storage Condition 】, above.

This product must be required to perform baking process (moisture removal) for **at 10h( MIN.) to 12h(MAX.) at 60±5 degrees Celsius** if following conditions apply.

1. In the case of silica gel (blue) which indicates the moisture level within the package, changes or loses its blue color.
2. In the case of time passes for 168h after the package is opened once.

Baking process should be performed after LED having been taken out of the package.

Baking may be performed in the tape-reel form , however if it is performed with the reel stacked over one another, it may cause deformation of the reels and taping materials and later obstruct mounting. Please handle only once it has returned to room temperature. Provided that, baking process shall be 2 times MAX.

**【Moisture-proof Packaging Specification】**

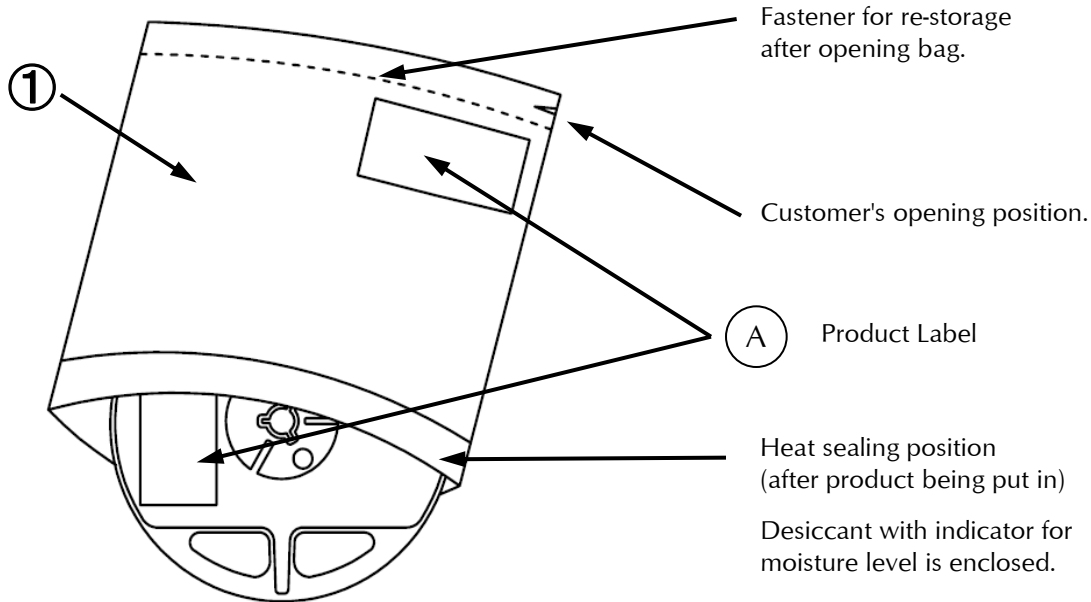

SYM.	PART NAME	MATELRIAL	REMARKS
①	Moisture-proof bag with Aluminum layer	PET+Al+PE	with ESD protection

**【Flow Chart-package Opening to Mounting】**

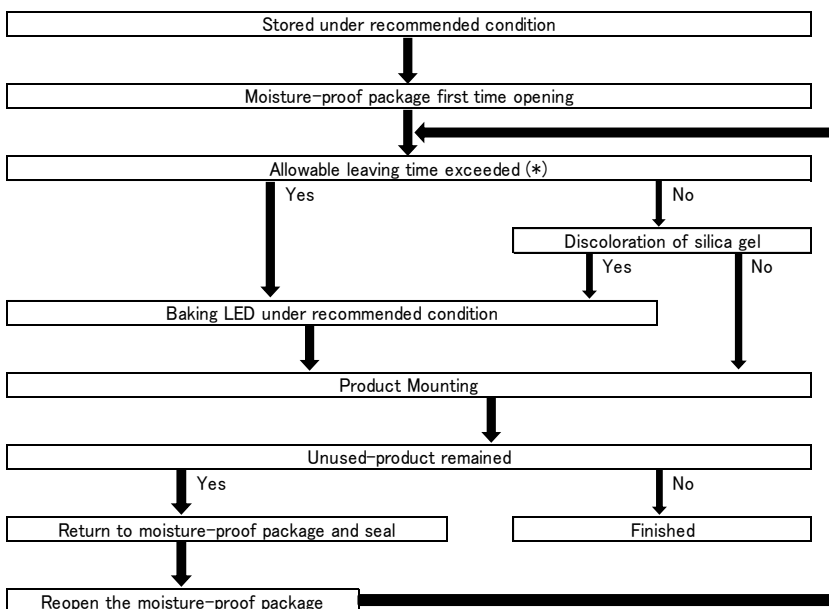

Allowable leaving time means the maximum allowable leaving time after opening package, which depends on each LED type. The allowable leaving time should be calculated from the first opening of package to the time when soldering process is finished. When judging if the allowable leaving time has exceeded or not, please subtract the soldering time. The allowable leaving time after reopening should be calculated from the first opening of package, or from the time when baking process is finished.

# Packaging Specifications

TDN1111C-TR

## 【 Packing box 】

( RoHS•ELV Compliant)

Box Type	Outline dimension L × W × H (mm)	Capacity of the box
Type A	280 × 265 × 45 (mm)	3 reels
Type B	310 × 235 × 265 (mm)	15 reels
Type C	440 × 310 × 265 (mm)	30 reels

The above measure is all the reference value.

The box is selected out of the above table by shipping quantity.

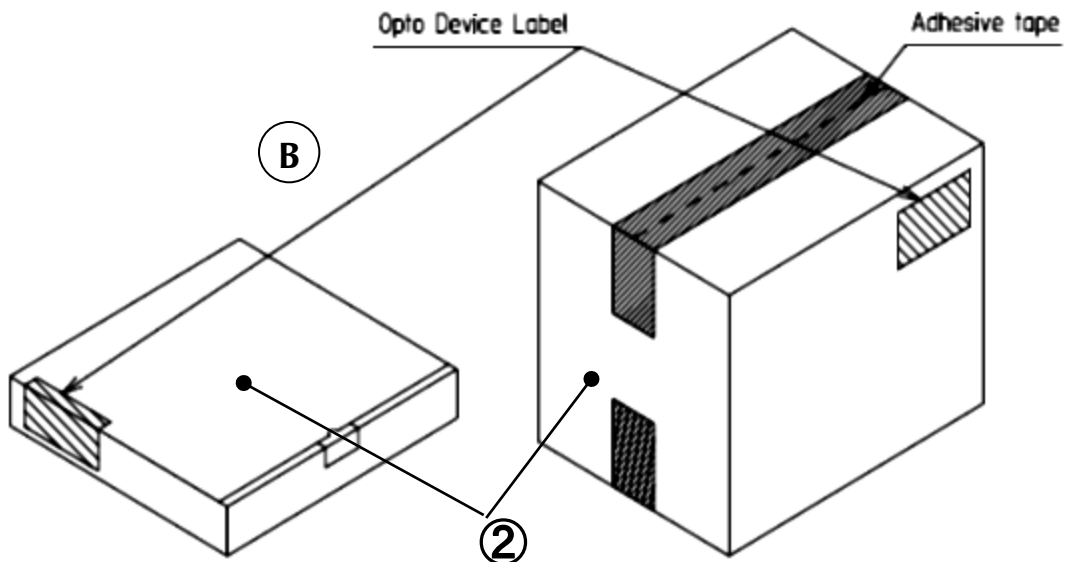

Type A

Material / box : Cardboard C5BF

Type B,C

Material / box : Cardboard K5AF

Partition : Cardboard K5AF

No.	PART NAME	MATELRIAL	REMARKS
②	Packing Box	Corrugated Cardboard	without ESD protection

## 【 Label Specification】

( acc.to ; JIS-X0503(Code-39)

### A Product label

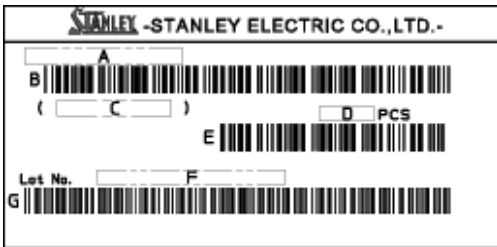

- A. Parts number
- B. Bar-code for parts number
- C. Parts code (In-house identification code for each parts number)
- D. Packed parts quantity
- E. Bar-Code for packed parts quantity
- F. Lot number & Rank (16 digits)
- G. Bar-Code for Lot number & Rank

### B Opto device label

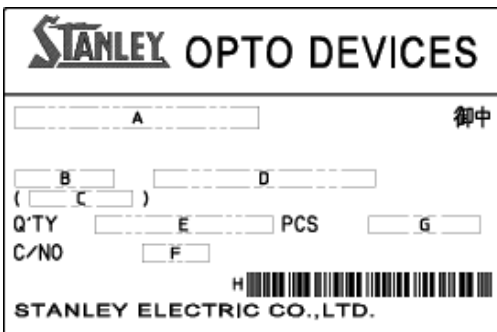

- A. Custmer Name
- B. Parts Type
- C. Parts Code
- D. Parts Number
- E. Packed Parts Quantity
- F. Carton Number
- G. Shipping Date
- H. Bar-Code for In-house identification Number

<Remark> Bar-code font : acc.to Code-39(JIS-X0503)



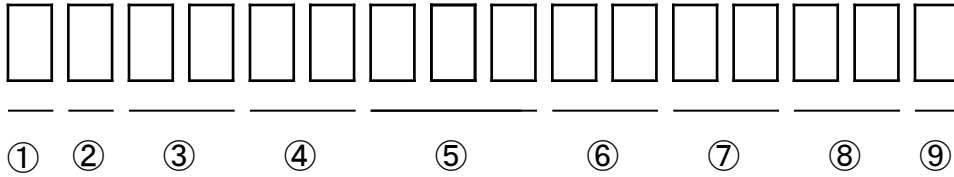

① - 1digit : Production Location (Mark identify alphabet)

② - 1digit : Production Year (Last digit of Production Year 2009→9,2010→0,2011→1,···)

③ - 2digits : Production Month (Jan. to Sep. , should be 01,02,03,·····)

④ - 2digits : Production Date

⑤ - 3digits : Serial Number

⑥ - 2digits : Tape and Reel following Number

⑦ - 2digits : Luminous Intensity Rank.

(If luminous intensity rank is 1 digit, "-" shall be dashed on the place for the second digit.  
If there is no identified intensity rank, "- ." is used to indicate.)

⑧ - 2digits : Chromaticity Rank

(If chromaticity rank is 1 digit, "-" shall be dashed on the place for the second digit.  
If there is no identified intensity rank, "- ." is used to indicate.)

⑨ - 1digit : Option Rank (Stanley normally print "-" to indicate)

# Taping and Reel Specifications

TDN1111C-TR

(acc.to ; JIS-C0806-03)

## 1. Appearance

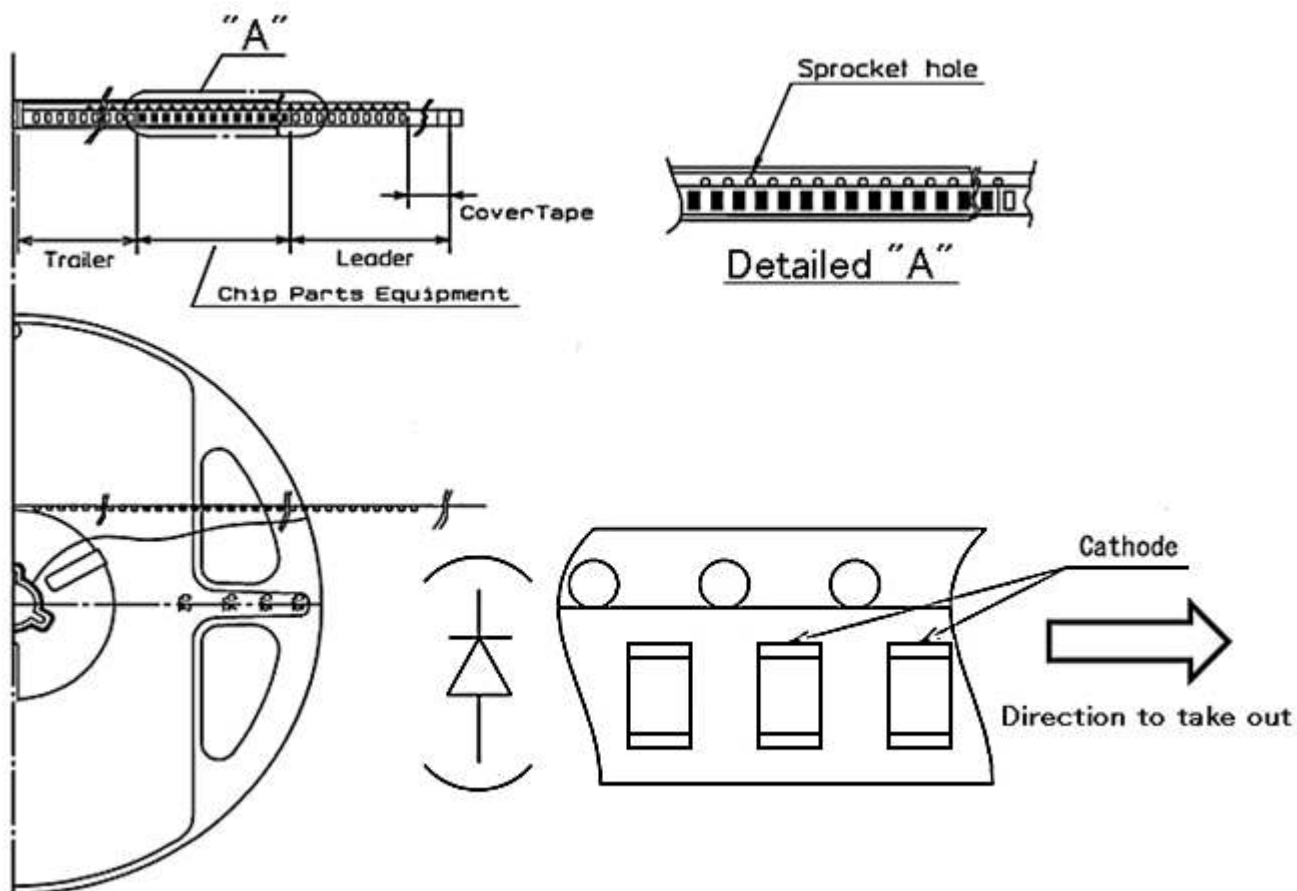

### Note

"-TR" means cathode side of LEDs should be placed on the sprocket-hole side.

ITEMS		SPECIFICATIONS	REMARKS
Leader area	Cover-tape	Cover-tape shall be longer than 200mm without carrier-tape	The end of cover-tape shall be held with adhesive tape.
	Carrier-tape	Empty pocket shall be more than 10 pieces.	Please refer to the above figure for Taping & reel orientation .
Trailer area		Empty pocket shall be more than 15 pieces.	The end of taping shall be inserted into a slit of the hub.

## Taping and Reel Specifications

---

(acc.to ; JIS-C0806-03)

### 2. Qty. per Reel

4,000parts/reel

### 3. Mechanical strength

Cover-tape adhesive strength shall be 0.1~1.0N

( An angle between carrier-tape and cover-tape shall be170 deg. )

Both tapes shall be so sealed that the contained parts will not come out from the tape when it is bent at a radius of 15mm.

### 4. Others

Reversed-orientation, Up-side down placing, side placing and out of spec. parts mix shall not be held. The number of empty pocket within a reel is made into 5p or less.

# Taping and Reel Specifications

TDN1111C-TR

Unit : mm

(acc.to ; JIS-C0806-03)

## 5. Taping Dimensions

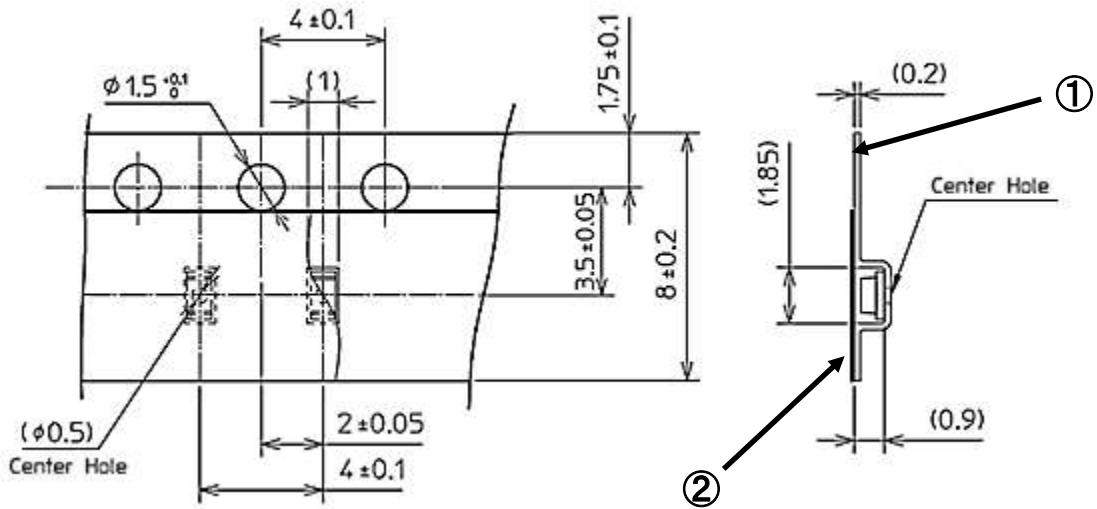

## 6. Reel Dimensions

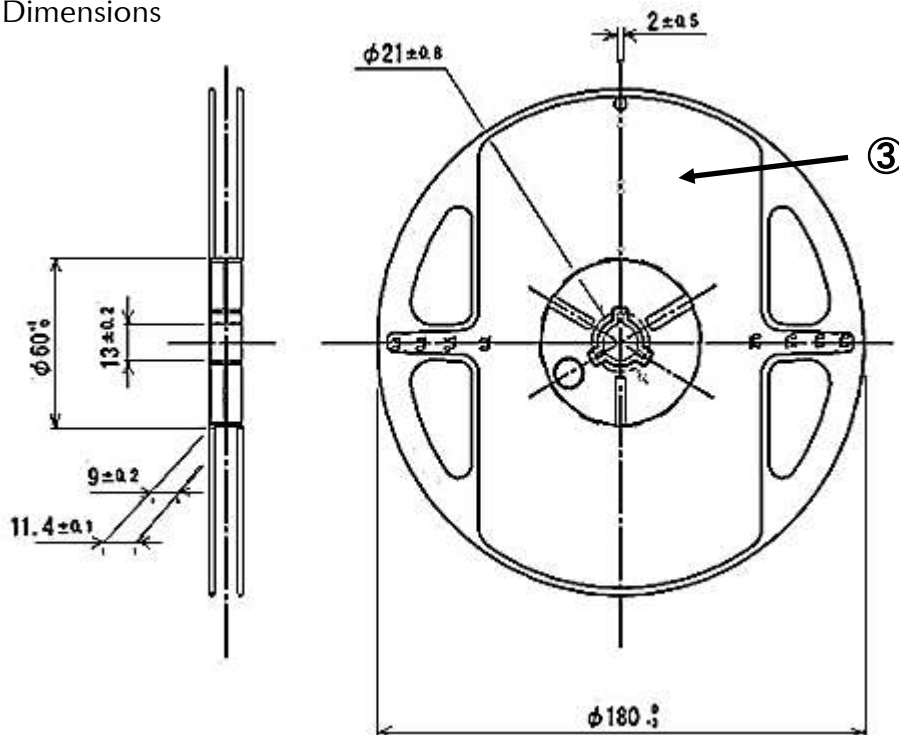

SYMBOL	PART NAME	REMARKS
①	Carrier-tape	with ESD protection
②	Cover-tape	with ESD protection
③	Carrier-reel	without ESD protection

This product is in compliance with RoHS•ELV.

Prohibition substance and it's criteria value of RoHS•ELV are as follows.

- RoHS instruction ..... Refer to following (1)~(6).
- ELV instruction ..... Refer to following (1)~(4).

	Substance Group Name	Criteria Value
(1)	Lead and its compounds	1,000ppm Max
(2)	Cadmium and its compounds	100ppm Max
(3)	Mercury and its compounds	1,000ppm Max
(4)	Hexavalent chromium	1,000ppm Max
(5)	PBB	1,000ppm Max
(6)	PBDE	1,000ppm Max

## 1. Reliability Testing Result

TEST ITEM	TEST CONDITION	DURATION	FAILURE
Operating life	Ta=25°C I <sub>F</sub> =50mA	1,000h	0/20
Humidity (Steady state)	Ta=60°C Rh=90%	1,000h	0/20
High temperature (Storage)	Ta=100°C	1,000h	0/20
Low temperature (Storage)	Ta=-40°C	1,000h	0/20
Temperature cycling	-40°C (30min.) ~ 25°C (15min.) ~ 100°C (30min.) ~ 25°C (15min.)	5cycles	0/20
Resistance to soldering heat	Pre-heating : 150~180°C 120s MAX. Operation heating : 230°C 40s Max. Peak temp. 260°C MAX	2 times	0/20
Vibration fatigue	98.1m/s <sup>2</sup> (10G) 100~2,000Hz 20min. Sweep XYZdirection	2h of each direction	0/20

## 2. Failure Criteria

Item	Symbol	Conditions	Failure Criteria
Radiant Intensity	I <sub>E</sub>	I <sub>F</sub> =20mA	Testing Min. Value < Standard Min. Value × 0.5
Forward Voltage	V <sub>F</sub>	I <sub>F</sub> =20mA	Testing Max. Value ≥ Standard Max. Value × 1.2
Reverse Current	I <sub>R</sub>	V <sub>R</sub> =5V	I <sub>R</sub> ≥ Testing Max. Value × 2.5
Cosmetic appearance	-	-	Notable Discoloration, Deformation and Cracking

## Special Notice to Customers Using the Products and Technical Information Shown in This Data Sheet

- 1) The technical information shown in the data sheets are limited to the typical characteristics and circuit examples of the referenced products. It does not constitute the warranting of industrial property nor the granting of any license.
- 2) For the purpose of product improvement, the specifications, characteristics and technical data described in the data sheets are subject to change without prior notice. Therefore it is recommended that the most updated specifications be used in your design.
- 3) When using the products described in the data sheets, please adhere to the maximum ratings for operating voltage, heat dissipation characteristics, and other precautions for use. We are not responsible for any damage which may occur if these specifications are exceeded.
- 4) The products that have been described to this catalog are manufactured so that they will be used for the electrical instrument of the benchmark (OA equipment, telecommunications equipment, AV machine, home appliance and measuring instrument).  
The application of aircrafts, space borne application, transportation equipment, medical equipment and nuclear power control equipment, etc. needs a high reliability and safety, and the breakdown and the wrong operation might influence the life or the human body. Please consult us beforehand if you plan to use our product for the usages of aircrafts, space borne application, transportation equipment, medical equipment and nuclear power control equipment, etc. except OA equipment, telecommunications equipment, AV machine, home appliance and measuring instrument.
- 5) In order to export the products or technologies described in this data sheet which are under the "Foreign Exchange and Foreign Trade Control Law," it is necessary to first obtain an export permit from the Japanese government.
- 6) No part of this data sheet may be reprinted or reproduced without prior written permission from Stanley Electric Co., Ltd.
- 7) The most updated edition of this data sheet can be obtained from the address below:  
<http://www.stanley-components.com/en/>