

Description:

25254 GNSS Patch Antenna

PART NUMBER: ANT2525B00DTGNSSS

Features:

- Size : 25x25x4 mm
- High radiation efficiency
- Pin-solder process
- RoHS compliant



Applications:

- Navigation device
- Telematics box
- Fleet management

In the effort to improve our products, we reserve the right to make changes judged to be necessary.

CONFIDENTIAL AND PROPRIETARY INFORMATION

This document contains confidential and proprietary information of Pulse Electronics, Inc. (Pulse) and is protected by copyright, trade secret and other state and federal laws. Its receipt or possession does not convey any rights to reproduce, disclose its contents, or to manufacture, use or sell anything it may describe. Reproduction, disclosure or use without specific written authorization of Pulse is strictly forbidden.

For more information:



Description:

25254 GNSS Patch Antenna

PART NUMBER: ANT2525B00DTGNSSS

ELECTRICAL SPECIFICATIONS

Working Frequency

BEIDOU: 1561 MHz

GPS: 1575 MHz

GLONASS: 1602 MHz

Gain

BEIDOU: 5.0 dBic (Typ.)

GPS: 5.4 dBic (Typ.)

GLONASS: 5.6 dBic (Typ.)

VSWR.

3.0 Max.

Polarization

Right Hand Circular Polarization

Axis Ratio

≤ 10 dBi

Impedance

50 Ω

Operating Temperature

- 30~85 °C

NOTE

1. Based on 70×70 mm² square ground plane.
2. Centre frequency will be offset to working frequency while changes of customer's housing and ground plane.

MECHANICAL DRAWING

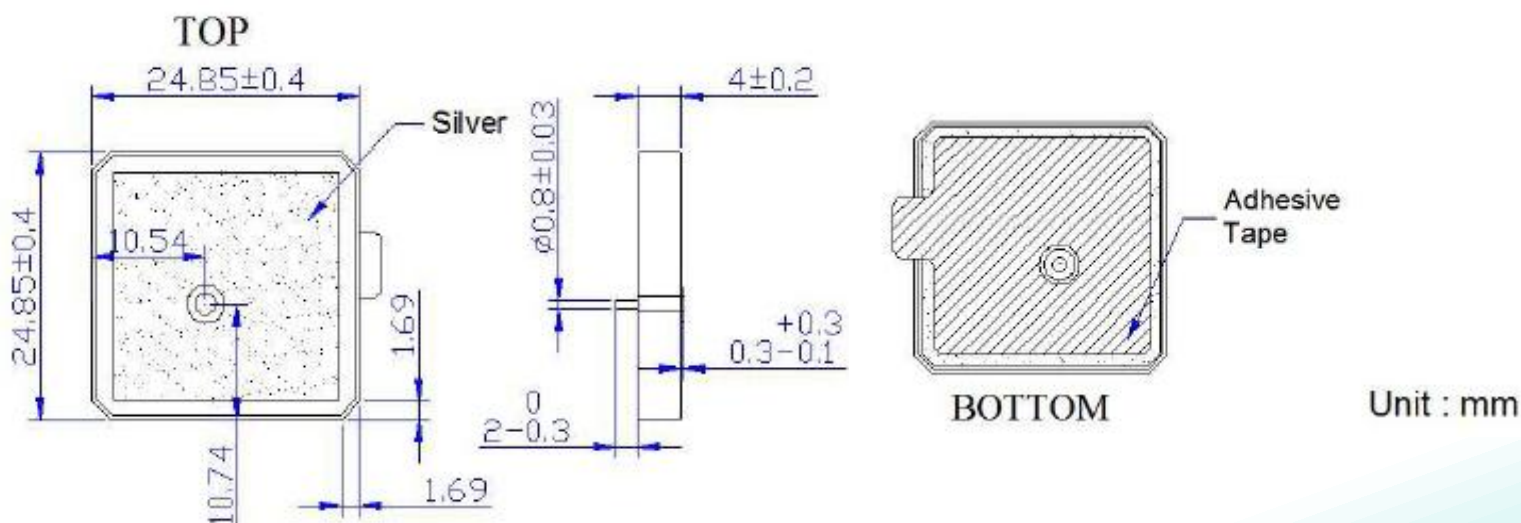

Unit : mm

Mechanical Data

In the effort to improve our products, we reserve the right to make changes judged to be necessary.

CONFIDENTIAL AND PROPRIETARY INFORMATION

This document contains confidential and proprietary information of Pulse Electronics, Inc. (Pulse) and is protected by copyright, trade secret and other state and federal laws. Its receipt or possession does not convey any rights to reproduce, disclose its contents, or to manufacture, use or sell anything it may describe. Reproduction, disclosure or use without specific written authorization of Pulse is strictly forbidden.

Description:

25254 GNSS Patch Antenna

PART NUMBER: ANT2525B00DTGNSSS

REFERENCE DESIGN OF EVALUATION BOARD

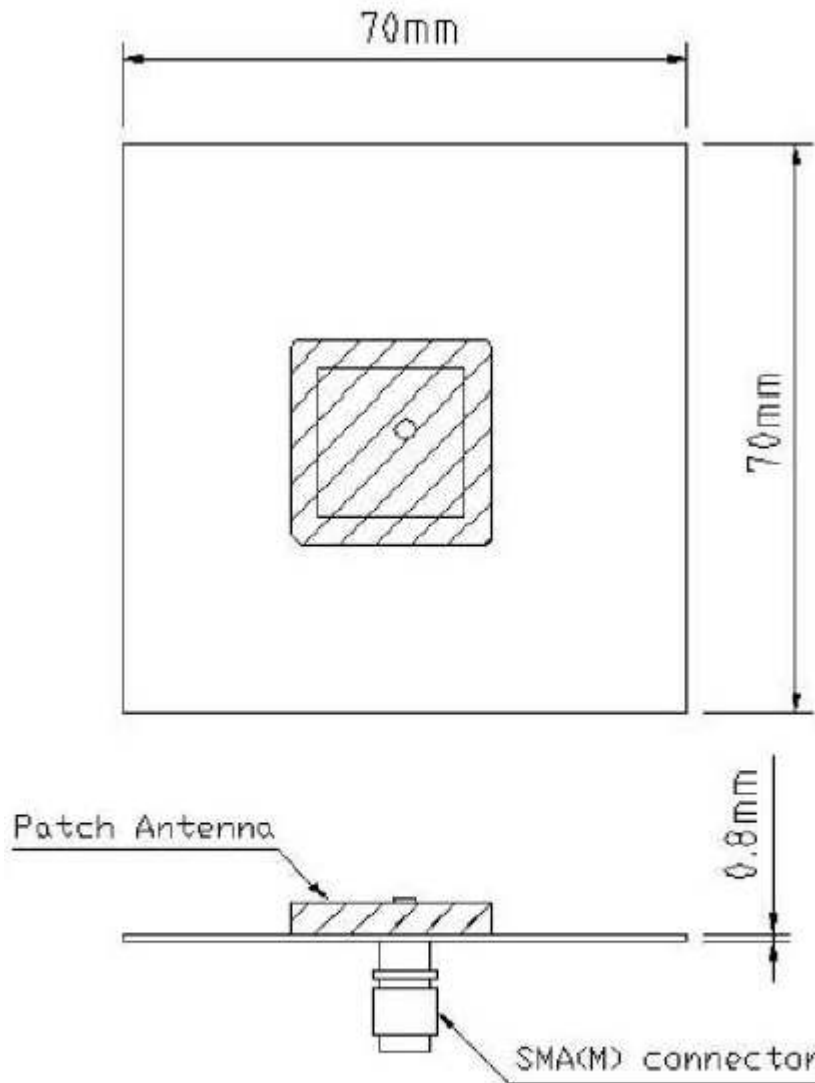

Ground Plane Size: 70x70 mm²

[] Evaluation Board

In the effort to improve our products, we reserve the right to make changes judged to be necessary.

CONFIDENTIAL AND PROPRIETARY INFORMATION

This document contains confidential and proprietary information of Pulse Electronics, Inc. (Pulse) and is protected by copyright, trade secret and other state and federal laws. Its receipt or possession does not convey any rights to reproduce, disclose its contents, or to manufacture, use or sell anything it may describe. Reproduction, disclosure or use without specific written authorization of Pulse is strictly forbidden.

Description:

25254 GNSS Patch Antenna

PART NUMBER: ANT2525B00DTGNSSS

REFERENCE DESIGN OF EVALUATION BOARD

Top View

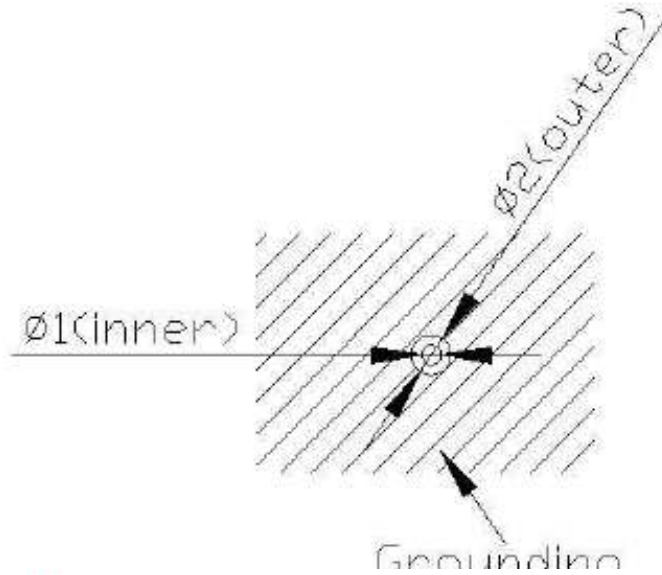

Bottom View

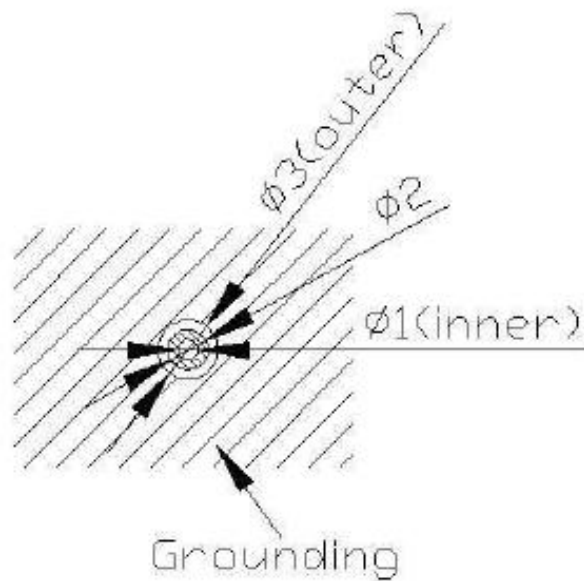

Layout Footprint Recommendation

In the effort to improve our products, we reserve the right to make changes judged to be necessary.

CONFIDENTIAL AND PROPRIETARY INFORMATION

This document contains confidential and proprietary information of Pulse Electronics, Inc. (Pulse) and is protected by copyright, trade secret and other state and federal laws. Its receipt or possession does not convey any rights to reproduce, disclose its contents, or to manufacture, use or sell anything it may describe. Reproduction, disclosure or use without specific written authorization of Pulse is strictly forbidden.

Description:

25254 GNSS Patch Antenna

PART NUMBER: ANT2525B00DTGNSSS

REFERENCE DESIGN OF EVALUATION BOARD

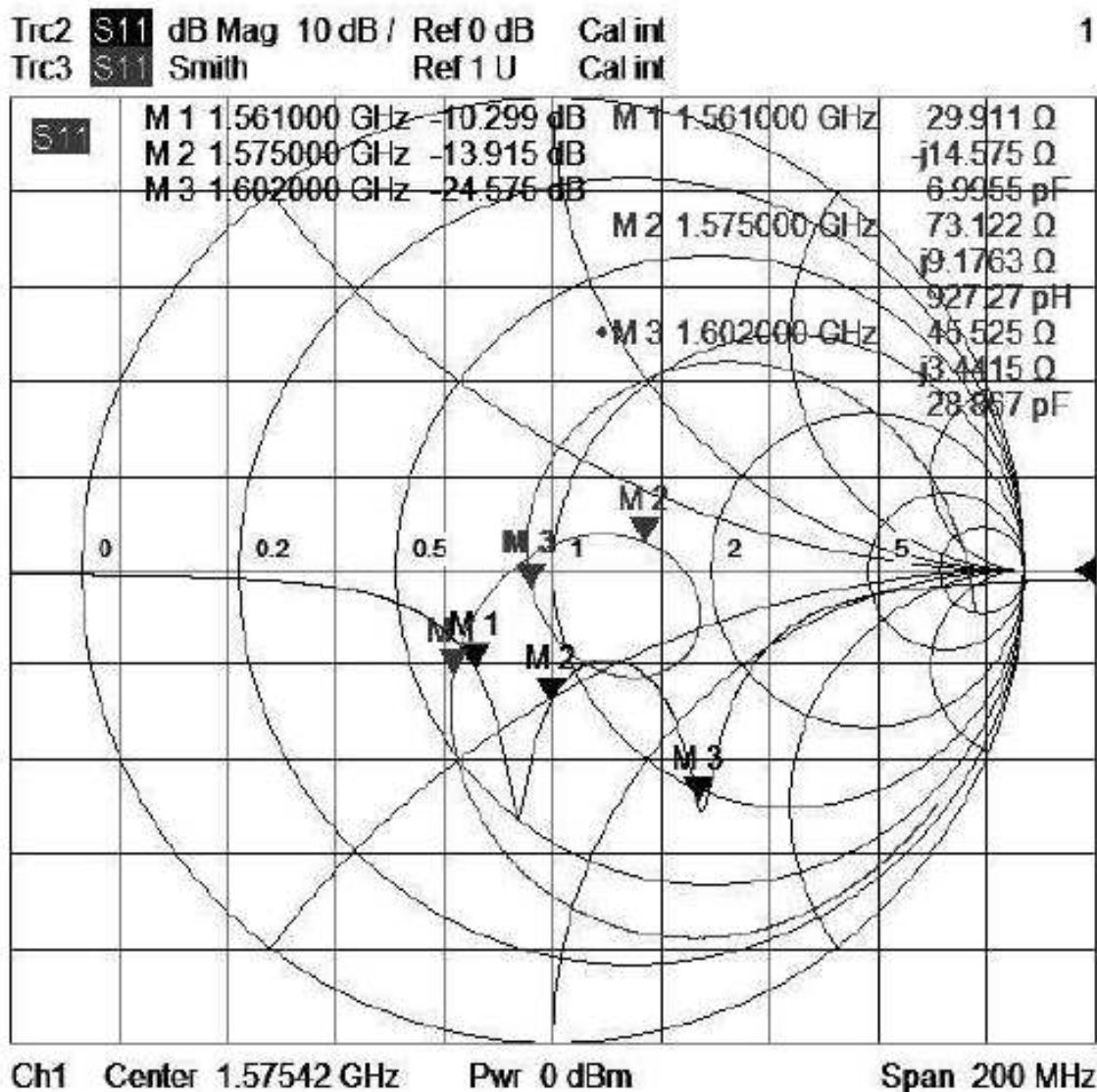

Return Loss

In the effort to improve our products, we reserve the right to make changes judged to be necessary.

CONFIDENTIAL AND PROPRIETARY INFORMATION

This document contains confidential and proprietary information of Pulse Electronics, Inc. (Pulse) and is protected by copyright, trade secret and other state and federal laws. Its receipt or possession does not convey any rights to reproduce, disclose its contents, or to manufacture, use or sell anything it may describe. Reproduction, disclosure or use without specific written authorization of Pulse is strictly forbidden.

Description:

25254 GNSS Patch Antenna

PART NUMBER: ANT2525B00DTGNSSS

REFERENCE DESIGN OF EVALUATION BOARD

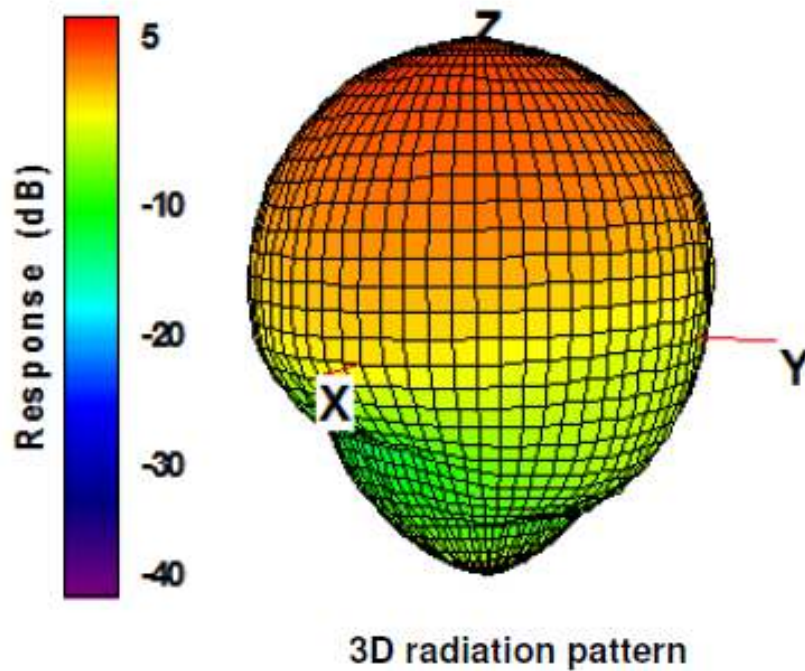
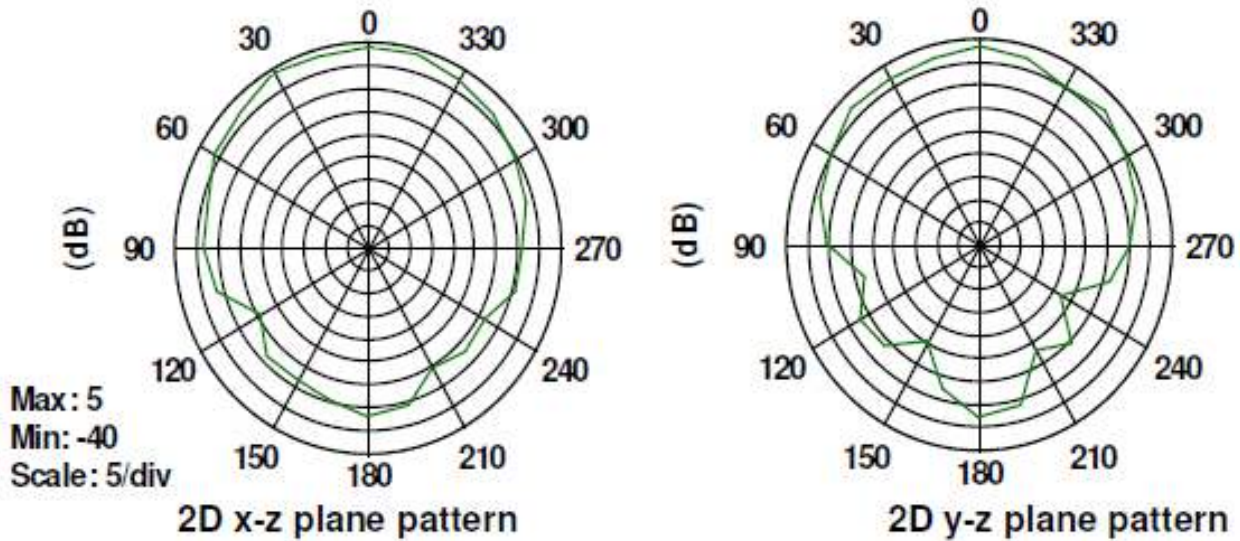

Radiation Pattern (Frequency = 1561MHz)

In the effort to improve our products, we reserve the right to make changes judged to be necessary.

CONFIDENTIAL AND PROPRIETARY INFORMATION

This document contains confidential and proprietary information of Pulse Electronics, Inc. (Pulse) and is protected by copyright, trade secret and other state and federal laws. Its receipt or possession does not convey any rights to reproduce, disclose its contents, or to manufacture, use or sell anything it may describe. Reproduction, disclosure or use without specific written authorization of Pulse is strictly forbidden.

Description:

25254 GNSS Patch Antenna

PART NUMBER: ANT2525B00DTGNSSS

REFERENCE DESIGN OF EVALUATION BOARD

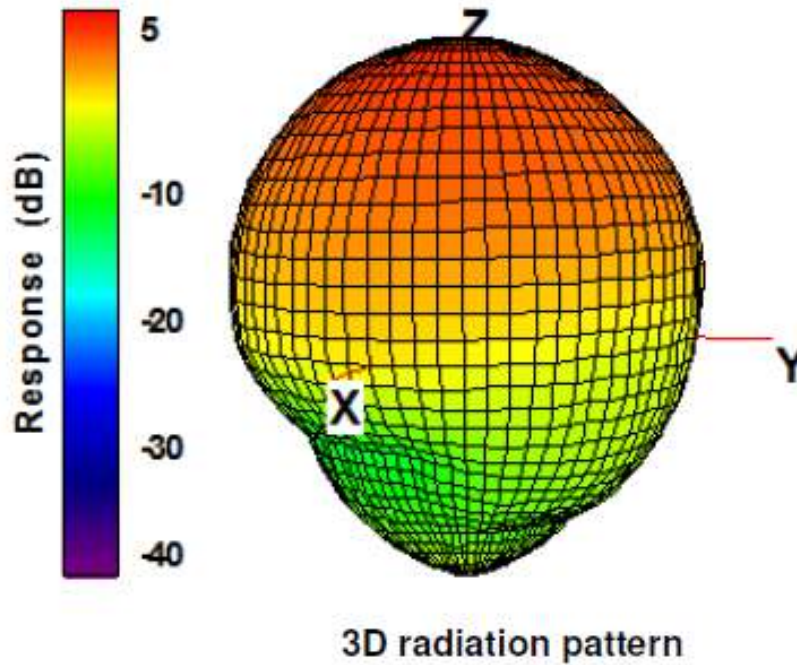
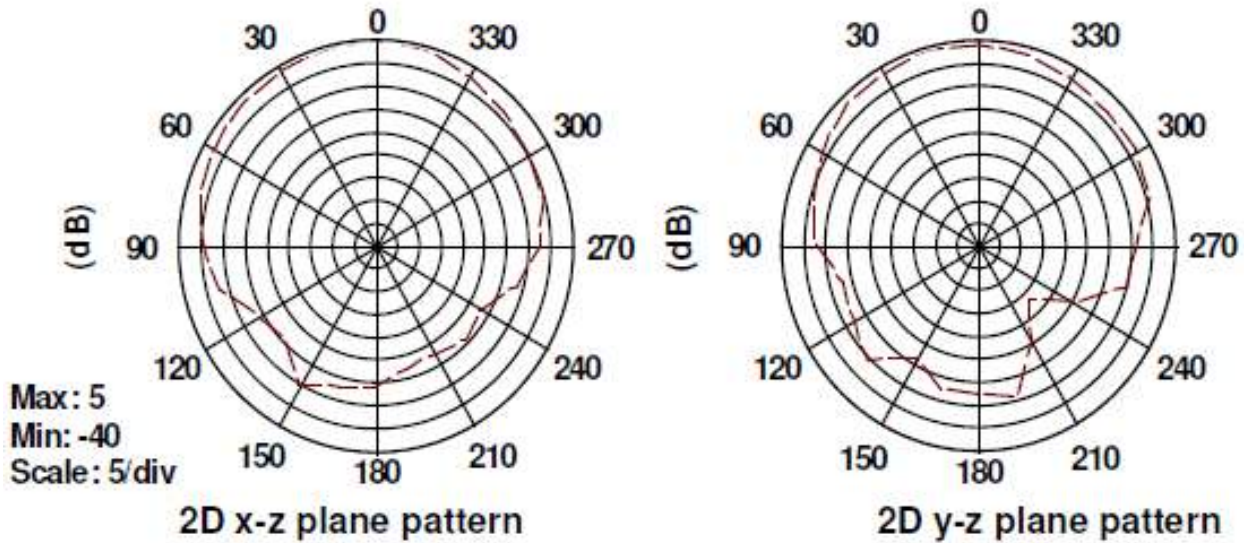

Radiation Pattern (Frequency = 1575MHz)

In the effort to improve our products, we reserve the right to make changes judged to be necessary.

CONFIDENTIAL AND PROPRIETARY INFORMATION

This document contains confidential and proprietary information of Pulse Electronics, Inc. (Pulse) and is protected by copyright, trade secret and other state and federal laws. Its receipt or possession does not convey any rights to reproduce, disclose its contents, or to manufacture, use or sell anything it may describe. Reproduction, disclosure or use without specific written authorization of Pulse is strictly forbidden.

Description:

25254 GNSS Patch Antenna

PART NUMBER: ANT2525B00DTGNSSS

REFERENCE DESIGN OF EVALUATION BOARD

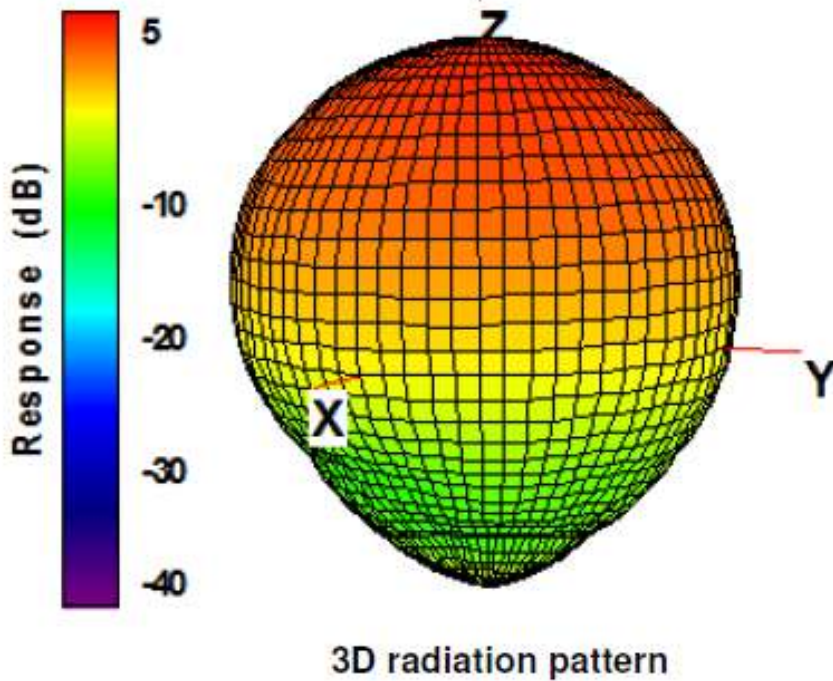
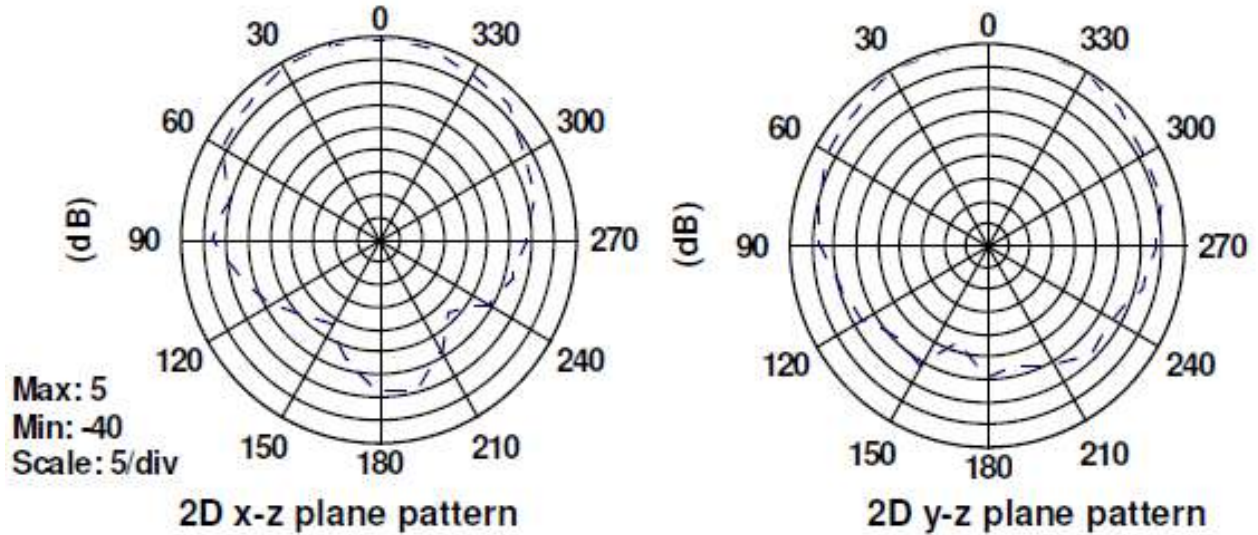

Radiation Pattern (Frequency = 1602MHz)

In the effort to improve our products, we reserve the right to make changes judged to be necessary.

CONFIDENTIAL AND PROPRIETARY INFORMATION

This document contains confidential and proprietary information of Pulse Electronics, Inc. (Pulse) and is protected by copyright, trade secret and other state and federal laws. Its receipt or possession does not convey any rights to reproduce, disclose its contents, or to manufacture, use or sell anything it may describe. Reproduction, disclosure or use without specific written authorization of Pulse is strictly forbidden.

Description:

25254 GNSS Patch Antenna

PART NUMBER: ANT2525B00DTGNSS

REVISION HISTORY

Revision	Date	Description
Version 1	Oct. 14, 2020	- New issue

In the effort to improve our products, we reserve the right to make changes judged to be necessary.

CONFIDENTIAL AND PROPRIETARY INFORMATION

This document contains confidential and proprietary information of Pulse Electronics, Inc. (Pulse) and is protected by copyright, trade secret and other state and federal laws. Its receipt or possession does not convey any rights to reproduce, disclose its contents, or to manufacture, use or sell anything it may describe. Reproduction, disclosure or use without specific written authorization of Pulse is strictly forbidden.

