

**CURRENT LIMITING LOW SIDE DRIVER**

**Features**

- Gate drive supply range from 12 to 18V
- Undervoltage lockout
- Current detection and limiting loop to limit driven power transistor current
- Error lead indicates fault conditions and programs shutdown time
- Output in phase with input
- 2.5V, 5V and 15V input logic compatible
- Also available LEAD-FREE

**Description**

The IR2121 is a high speed power MOSFET and IGBT driver with over-current limiting protection circuitry. Latch immune CMOS technology enables ruggedized monolithic construction. Logic inputs are compatible with standard CMOS or LSTTL outputs, down to 2.5V logic. The output driver features a high pulse current buffer stage designed for minimum cross-conduction. The protection circuitry detects over-current in the driven power transistor and limits the gate drive voltage. Cycle-by-cycle shutdown is programmed by an external capacitor which directly controls the time interval between detection of the over-current limiting condition and latched shutdown. The output can be used to drive an N-channel power MOSFET or IGBT in the low side configuration.

**Product Summary**

<b>V<sub>OFFSET</sub></b>	<b>5V max.</b>
<b>I<sub>O+/-</sub></b>	<b>1A / 2A</b>
<b>V<sub>OUT</sub></b>	<b>12 - 18V</b>
<b>V<sub>CSth</sub></b>	<b>230 mV</b>
<b>t<sub>on/off</sub> (typ.)</b>	<b>150 &amp; 150 ns</b>

**Package**

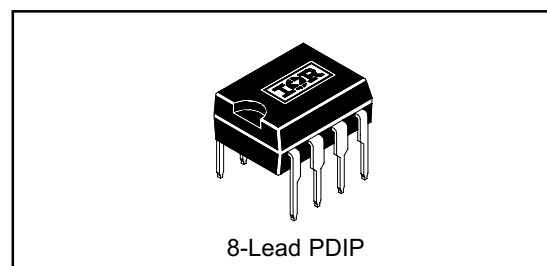

**Typical Connection**

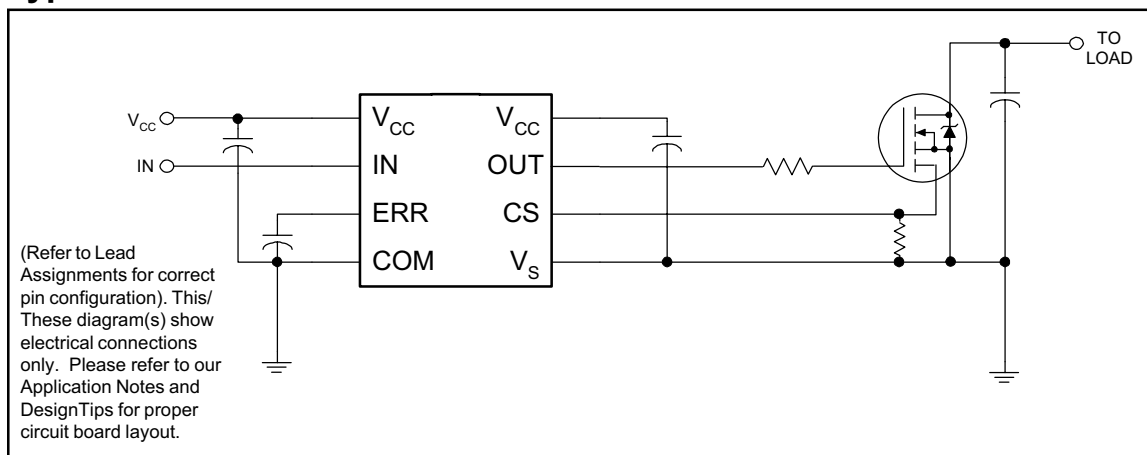

# IR2121 & (PbF)

## Absolute Maximum Ratings

Absolute Maximum Ratings indicate sustained limits beyond which damage to the device may occur. All voltage parameters are absolute voltages referenced to COM. The Thermal Resistance and Power Dissipation ratings are measured under board mounted and still air conditions.

Symbol	Parameter Definition	Value		Units
		Min.	Max.	
V <sub>CC</sub>	Fixed Supply Voltage	-0.3	25	V
V <sub>S</sub>	Gate Drive Return Voltage	V <sub>CC</sub> - 25	V <sub>CC</sub> + 0.3	
V <sub>O</sub>	Output Voltage	V <sub>S</sub> - 0.3	V <sub>CC</sub> + 0.3	
V <sub>IN</sub>	Logic Input Voltage	-0.3	V <sub>CC</sub> + 0.3	
V <sub>ERR</sub>	Error Signal Voltage	-0.3	V <sub>CC</sub> + 0.3	
V <sub>CS</sub>	Current Sense Voltage	V <sub>S</sub> - 0.3	V <sub>CC</sub> + 0.3	
P <sub>D</sub>	Package Power Dissipation @ T <sub>A</sub> ≤ +25°C	—	1.0	W
R <sub>thJA</sub>	Thermal Resistance, Junction to Ambient	—	125	°C/W
T <sub>J</sub>	Junction Temperature	—	150	°C
T <sub>S</sub>	Storage Temperature	-55	150	
T <sub>L</sub>	Lead Temperature (Soldering, 10 seconds)	—	300	

## Recommended Operating Conditions

The Input/Output logic timing diagram is shown in Figure 1. For proper operation the device should be used within the recommended conditions. The V<sub>S</sub> offset rating is tested with all supplies biased at 15V differential.

Symbol	Parameter Definition	Value		Units
		Min.	Max.	
V <sub>CC</sub>	Fixed Supply Voltage	V <sub>S</sub> + 12	V <sub>S</sub> + 18	V
V <sub>S</sub>	Gate Drive Return Voltage	-5	5	
V <sub>O</sub>	Output Voltage	V <sub>S</sub>	V <sub>CC</sub>	
V <sub>IN</sub>	Logic Input Voltage	0	V <sub>CC</sub>	
V <sub>ERR</sub>	Error Signal Voltage	0	V <sub>CC</sub>	
V <sub>CS</sub>	Current Sense Signal Voltage	V <sub>S</sub>	V <sub>CC</sub>	
T <sub>A</sub>	Ambient Temperature	-40	125	°C

## Dynamic Electrical Characteristics

$V_{BIAS}$  ( $V_{CC}$ ) = 15V,  $C_L$  = 3300 pF and  $T_A$  = 25°C unless otherwise specified. The dynamic electrical characteristics are defined in Figures 2 through 5.

Symbol	Parameter Definition	Figure	Value			Units	Test Conditions
			Min.	Typ.	Max.		
$t_{on}$	Turn-On Propagation Delay	7	—	150	200	ns	$V_{IN} = 0 \text{ \& } 5V$
$t_{off}$	Turn-Off Propagation Delay	8	—	200	250		
$t_{sd}$	ERR Shutdown Propagation Delay	9	—	1.7	2.2	$\mu s$	
$t_r$	Turn-On Rise Time	10	—	43	60	ns	
$t_f$	Turn-Off Fall Time	11	—	26	35		
$t_{cs}$	CS Shutdown Propagation Delay	12	—	0.7	1.2	$\mu s$	$C_{ERR} = 270 \text{ pF}$
$t_{err}$	CS to ERR Pull-Up Propagation Delay	13	—	9.0	12		

## Static Electrical Characteristics

$V_{BIAS}$  ( $V_{CC}$ ) = 15V and  $T_A$  = 25°C unless otherwise specified. The  $V_{IN}$ ,  $V_{TH}$  and  $I_{IN}$  parameters are referenced to COM. The  $V_O$  and  $I_O$  parameters are referenced to  $V_S$ .

Symbol	Parameter Definition	Figure	Value			Units	Test Conditions
			Min.	Typ.	Max.		
$V_{IH}$	Logic "1" Input Voltage	14	2.2	—	—	V	
$V_{IL}$	Logic "0" Input Voltage	15	—	—	0.8		
$V_{CSTH+}$	CS Input Positive Going Threshold	16	150	230	320	mV	
$V_{CSTH-}$	CS Input Negative Going Threshold	17	130	210	300		
$V_{OH}$	High Level Output Voltage, $V_{BIAS} - V_O$	18	—	—	100		$I_O = 0A$
$V_{OL}$	Low Level Output Voltage, $V_O$	19	—	—	100		$I_O = 0A$
$I_{QCC}$	Quiescent VCC Supply Current	20	—	1.1	2.2	$mA$	$V_{IN} = V_{CS} = 0V$ or $5V$
$I_{IN+}$	Logic "1" Input Bias Current	21	—	4.5	10	$\mu A$	$V_{IN} = 5V$
$I_{IN-}$	Logic "0" Input Bias Current	22	—	—	1.0		$V_{IN} = 0V$
$I_{CS+}$	"High" CS Bias Current	23	—	4.5	10		$V_{CS} = 3V$ or $5V$
$I_{CS-}$	"Low" CS Bias Current	24	—	—	1.0		$V_{CS} = 0V$
$V_{CCUV+}$	$V_{CC}$ Supply Undervoltage Positive Going Threshold	25	8.3	8.9	9.6	V	
$V_{CCUV-}$	$V_{CC}$ Supply Undervoltage Negative Going Threshold	26	7.3	8.0	8.7		
$I_{ERR}$	ERR Timing Charge Current	27	65	100	130	$\mu A$	$V_{IN} = 5V, V_{CS} = 3V$ $ERR < V_{ERR+}$
$I_{ERR+}$	ERR Pull-Up Current	28	8.0	15	—	$mA$	$V_{IN} = 5V, V_{CS} = 3V$ $ERR > V_{ERR+}$
$I_{ERR-}$	ERR Pull-Down Current	29	16	30	—		$V_{IN} = 0V$
$I_{O+}$	Output High Short Circuit Pulsed Current	30	1.0	1.6	—	A	$V_O = 0V, V_{IN} = 5V$ $PW \leq 10 \mu s$
$I_{O-}$	Output Low Short Circuit Pulsed Current	31	2.0	3.3	—		$V_O = 15V, V_{IN} = 0V$ $PW \leq 10 \mu s$

# IR2121 & (PbF)

## Functional Block Diagram

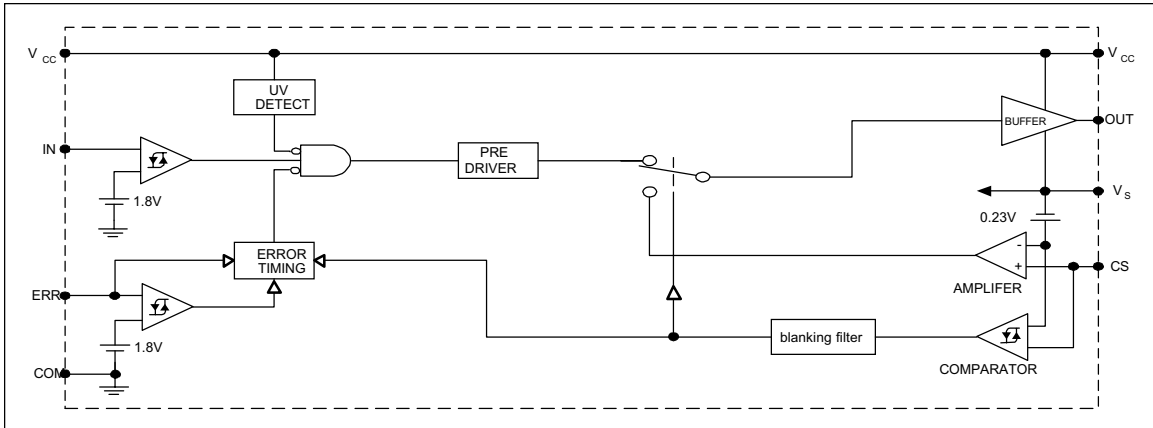

## Lead Definitions

Lead	
Symbol	Description
V <sub>CC</sub>	Logic and gate drive supply
IN	Logic input for gate driver output (OUT), in phase with OUT
ERR	Serves multiple functions; status reporting, linear mode timing and cycle by cycle logic shutdown
COM	Logic ground
OUT	Gate drive output
V <sub>S</sub>	Gate drive supply return
CS	Current sense input to current sense comparator

## Lead Assignments

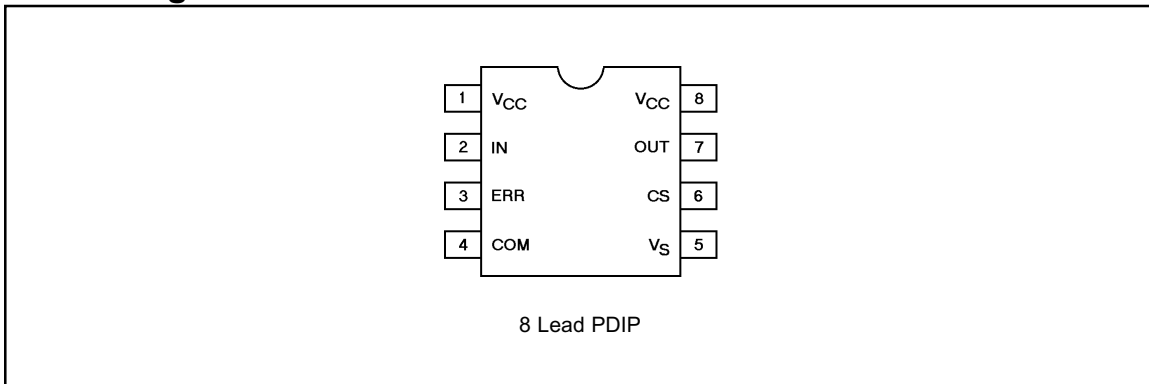

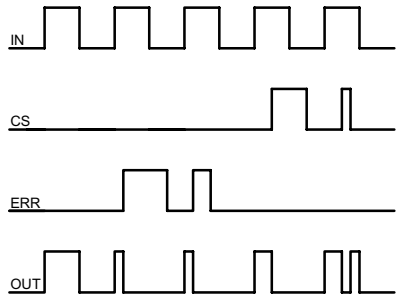

Figure 1. Input/Output Timing Diagram

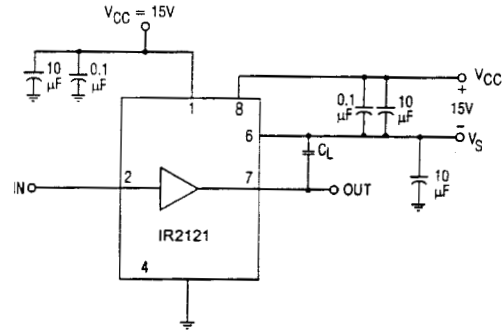

Figure 2. Switching Time Test Circuit

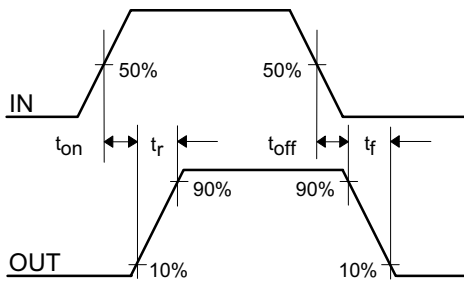

Figure 3. Switching Time Waveform Definitions

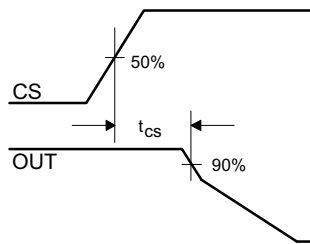

Figure 4. ERR Shutdown Waveform Definitions

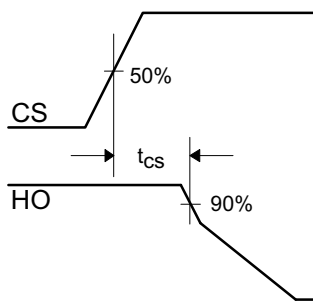

Figure 5. CS Shutdown Waveform Definitions

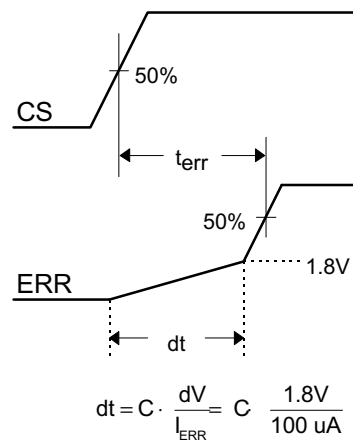
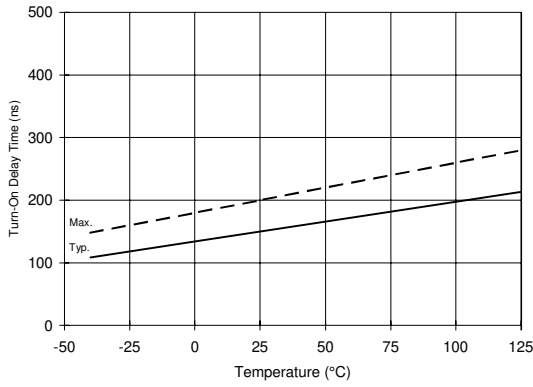
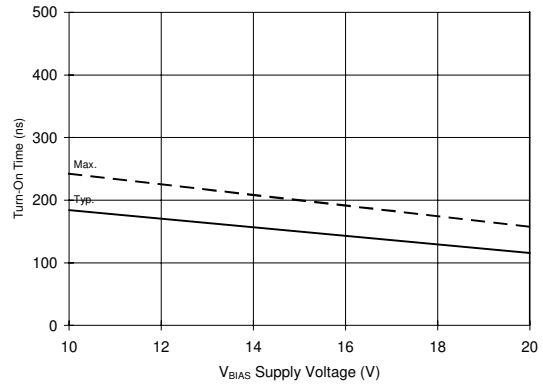

Figure 6. CS to ERR Waveform Definitions

# IR2121 & (PbF)



**Figure 7A. Turn-On Time vs. Temperature**



**Figure 7B. Turn-On Time vs. Voltage**

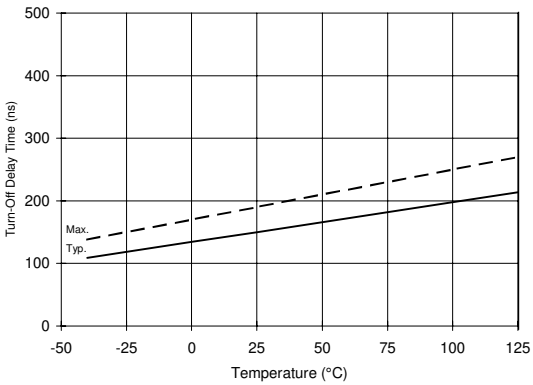

**Figure 8A. Turn-Off Time vs. Temperature**

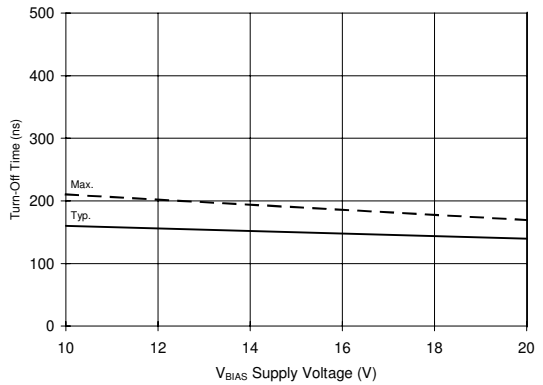

**Figure 8B. Turn-Off Time vs. Voltage**

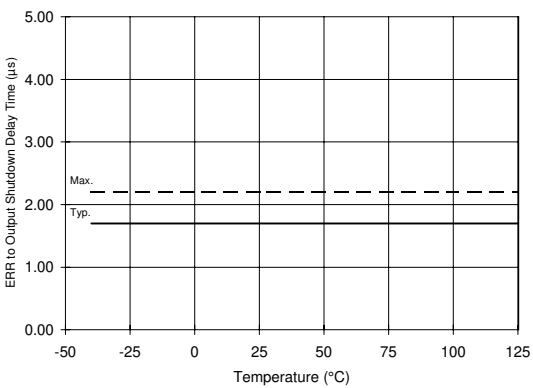

**Figure 9A. ERR to Output Shutdown vs. Temperature**

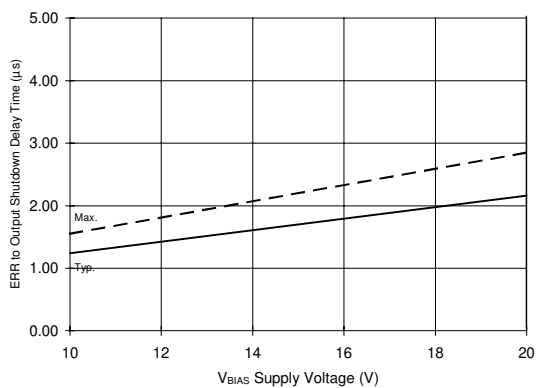

**Figure 9B. ERR to Output Shutdown vs. Voltage**

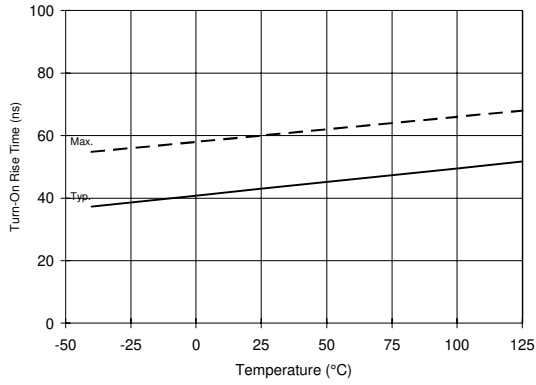

Figure 10A. Turn-On Rise Time vs. Temperature

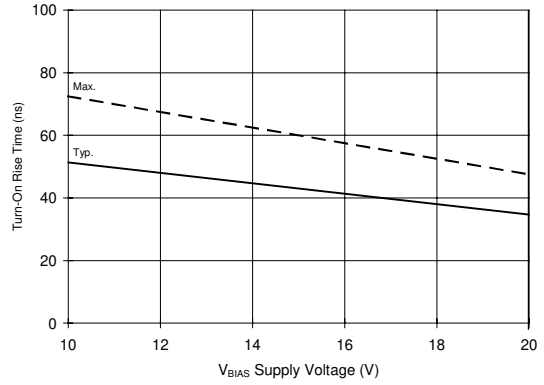

Figure 10B. Turn-On Rise Time vs. Voltage

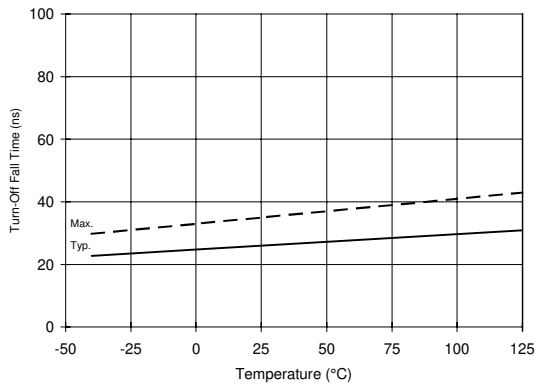

Figure 11A. Turn-Off Fall Time vs. Temperature

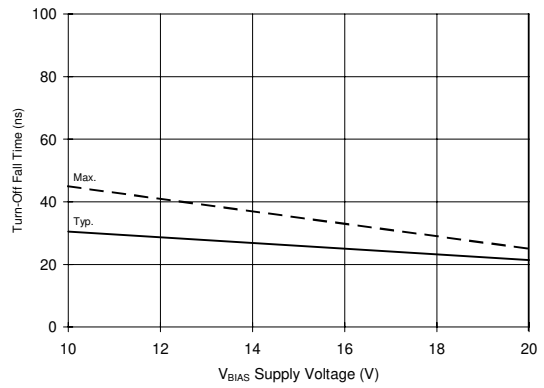

Figure 11B. Turn-Off Fall Time vs. Voltage

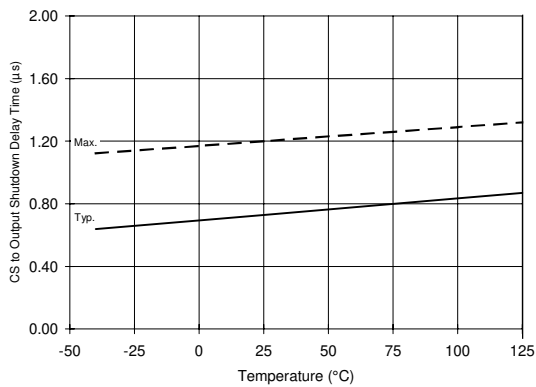

Figure 12A. CS to Output Shutdown vs. Temperature

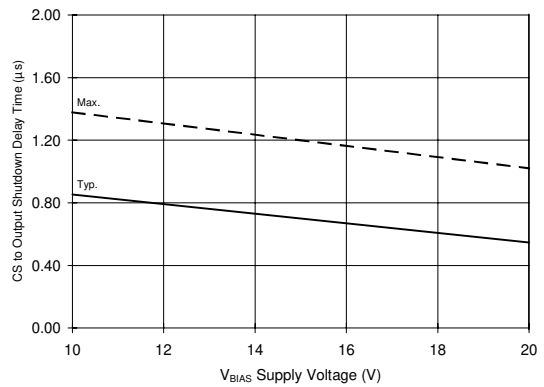

Figure 12B. CS to Output Shutdown vs. Voltage

# IR2121 & (PbF)

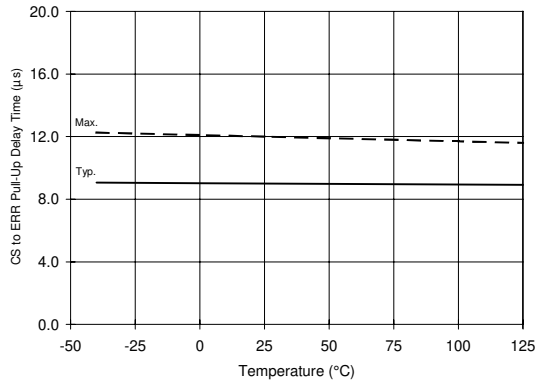

Figure 13A. CS to ERR Pull-Up vs. Temperature

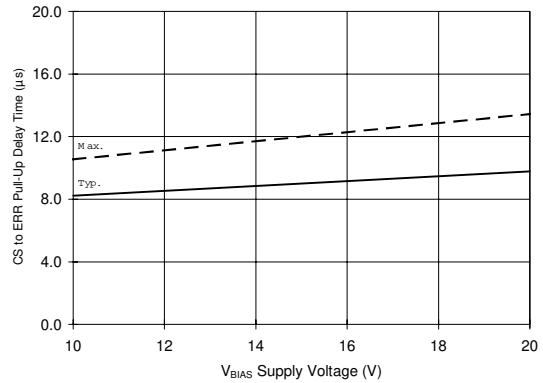

Figure 13B. CS to ERR Pull-Up vs. Voltage

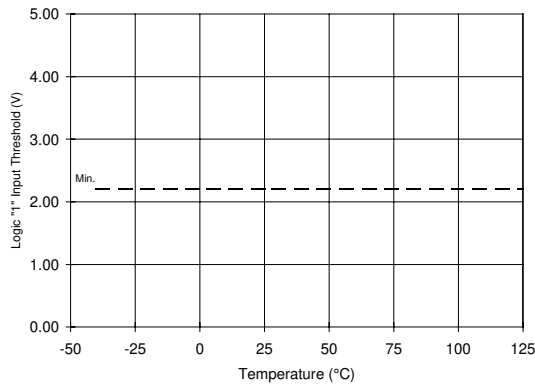

Figure 14A. Logic "1" Input Threshold vs. Temperature

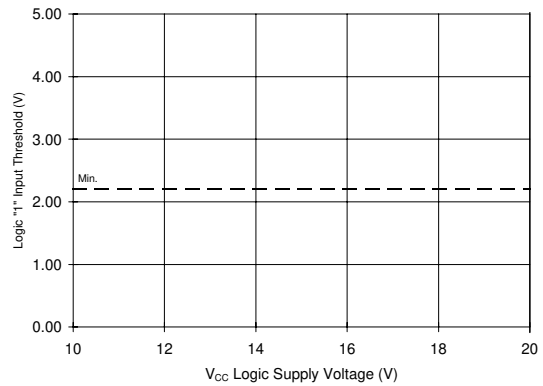

Figure 14B. Logic "1" Input Threshold vs. Voltage

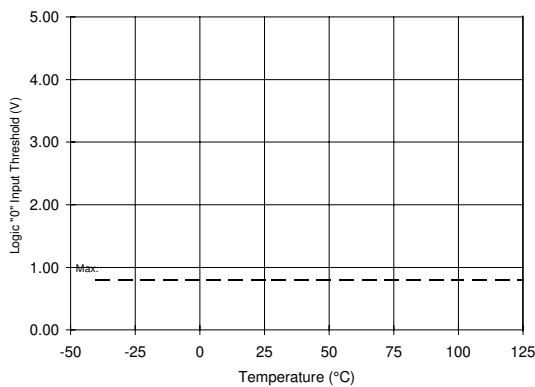

Figure 15A. Logic "0" Input Threshold vs. Temperature

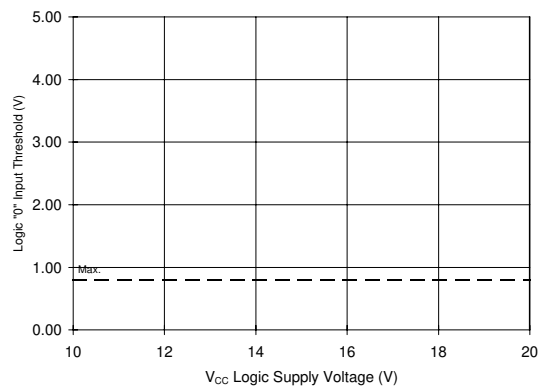

Figure 15B. Logic "0" Input Threshold vs. Voltage



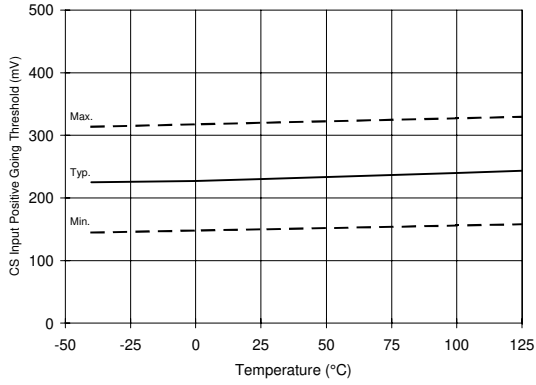

Figure 16A. CS Input Threshold (+) vs. Temperature

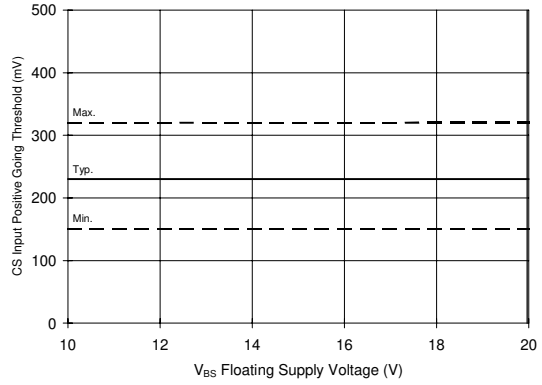

Figure 16B. CS Input Threshold (+) vs. Voltage

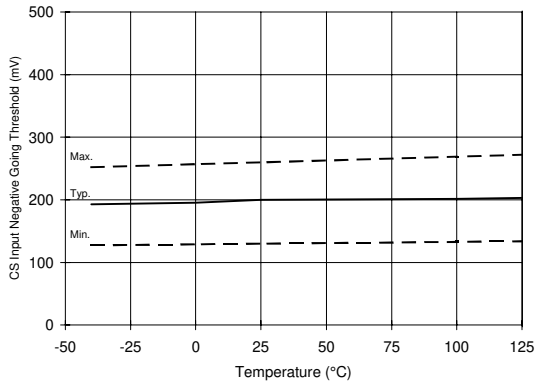

Figure 17A. CS Input Threshold (-) vs. Temperature

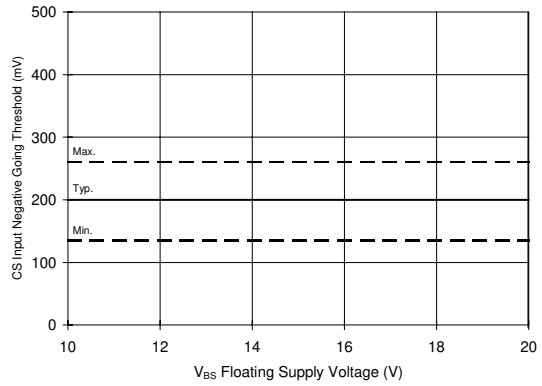

Figure 17B. CS Input Threshold (-) vs. Voltage

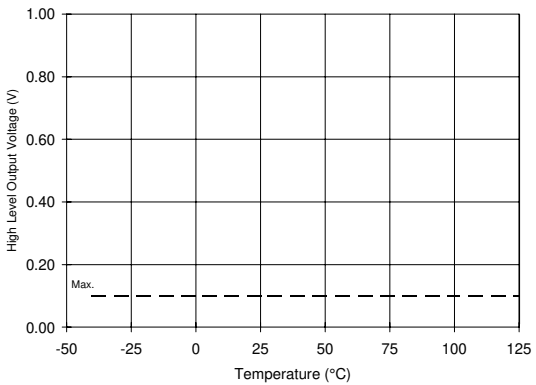

Figure 18A. High Level Output vs. Temperature

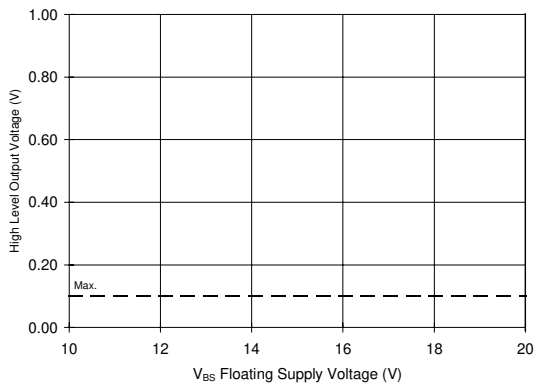

Figure 18B. High Level Output vs. Voltage

# IR2121 & (PbF)

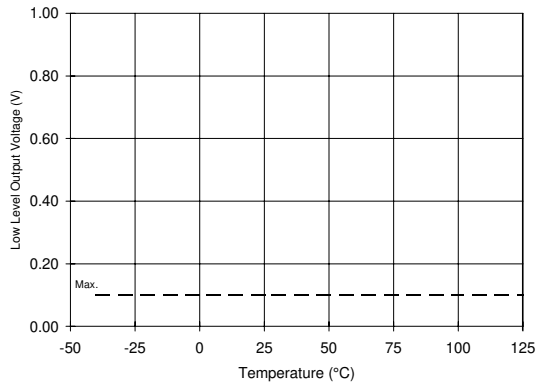

Figure 19A. Low Level Output vs. Temperature

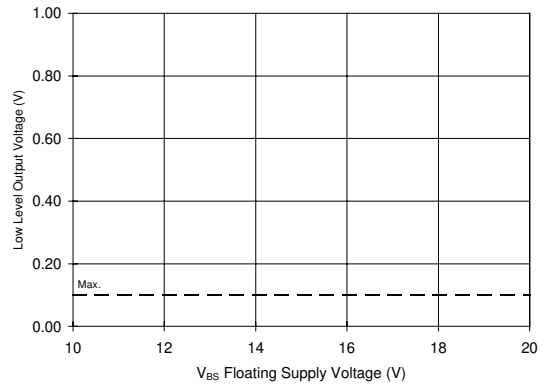

Figure 19B. Low Level Output vs. Voltage

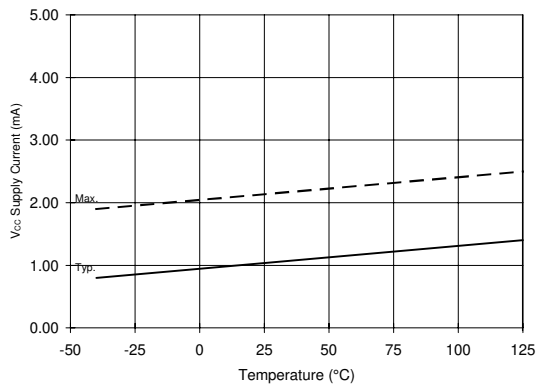

Figure 20A. V<sub>CC</sub> Supply Current vs. Temperature

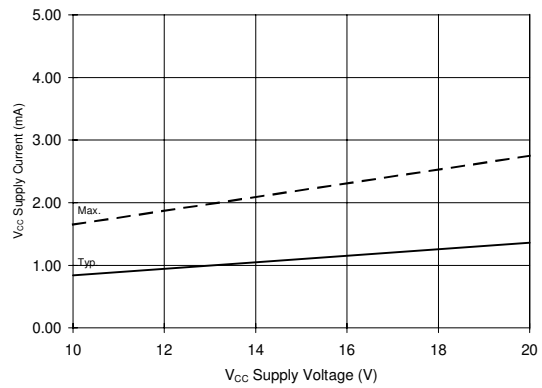

Figure 20B. V<sub>CC</sub> Supply Current vs. Voltage

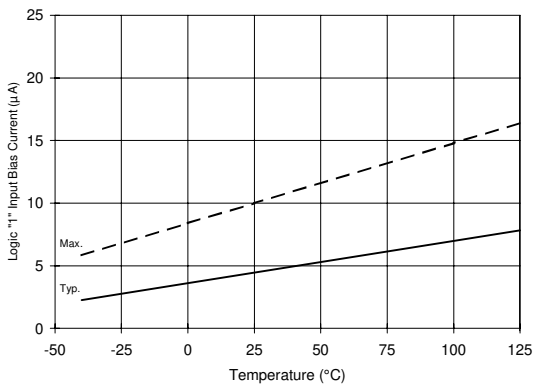

Figure 21A. Logic "1" Input Current vs. Temperature

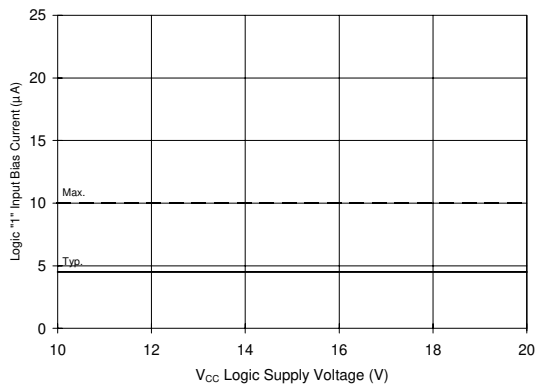

Figure 21B. Logic "1" Input Current vs. Voltage

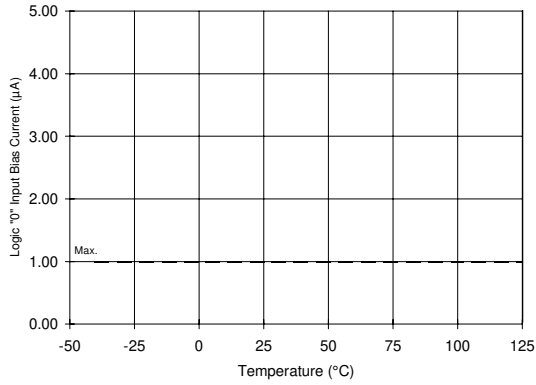

Figure 22A. Logic "0" Input Current vs. Temperature

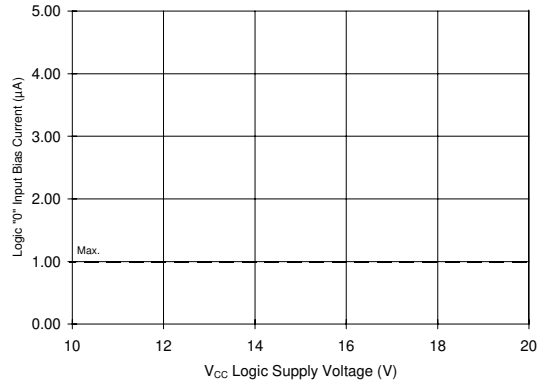

Figure 22B. Logic "0" Input Current vs. Voltage

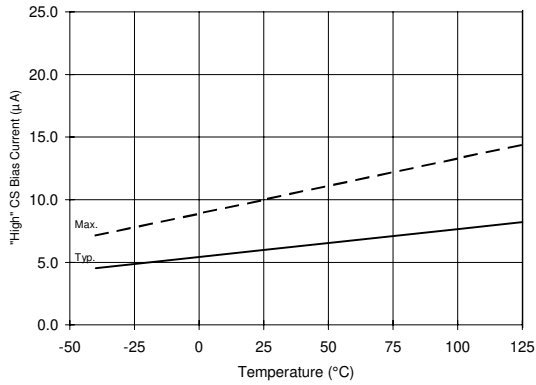

Figure 23A. "High" CS Bias Current vs. Temperature

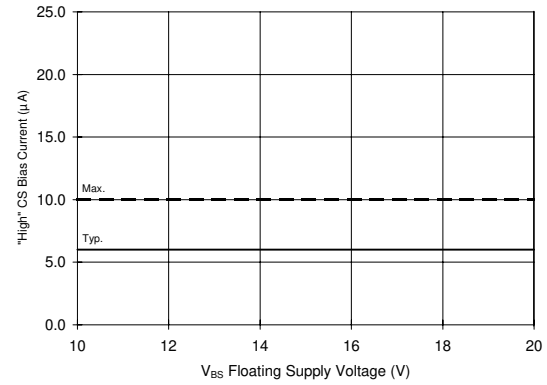

Figure 23B. "High" CS Bias Current vs. Voltage

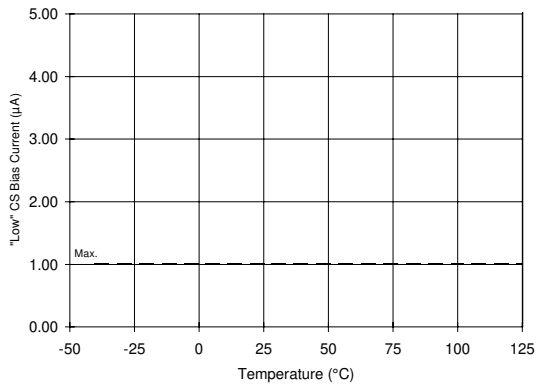

Figure 24A. "Low" CS Bias Current vs. Temperature

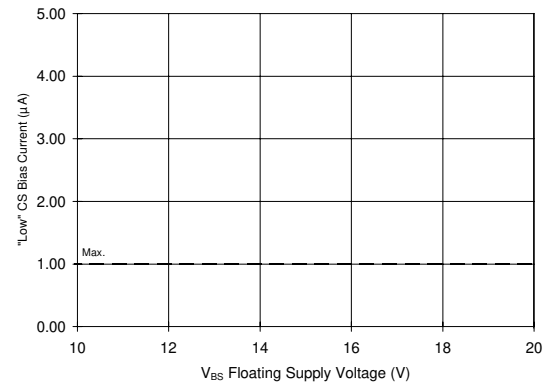

Figure 24B. "Low" CS Bias Current vs. Voltage

# IR2121 & (PbF)

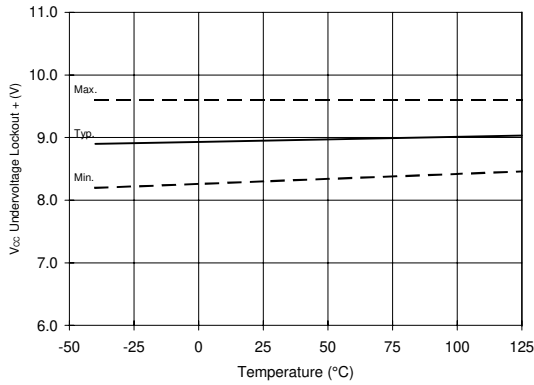

Figure 25.  $V_{CC}$  Undervoltage (+) vs. Temperature

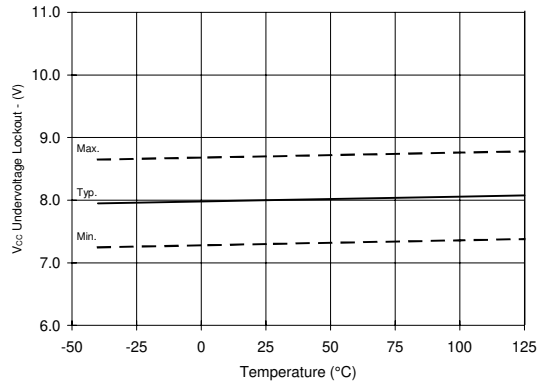

Figure 26.  $V_{CC}$  Undervoltage (-) vs. Temperature

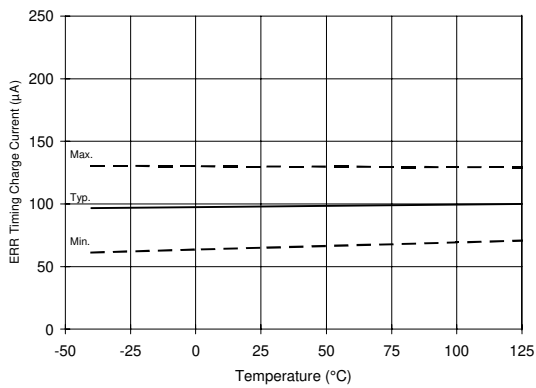

Figure 27A. ERR Timing Charge Current vs. Temperature

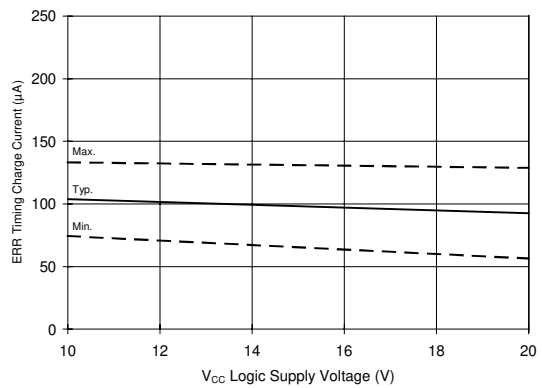

Figure 27B. ERR Timing Charge Current vs. Voltage

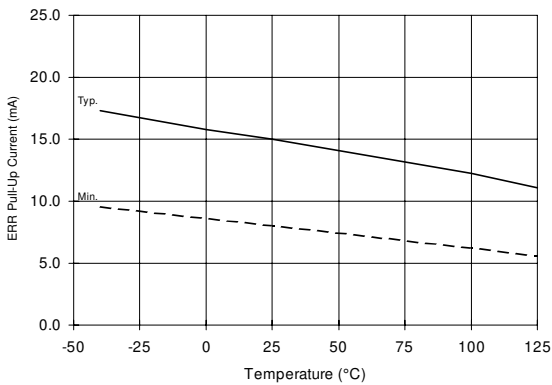

Figure 28A. ERR Pull-Up Current vs. Temperature

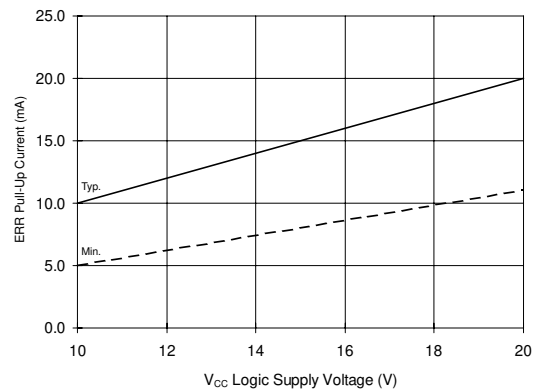

Figure 28B. ERR Pull-Up Current vs. Voltage

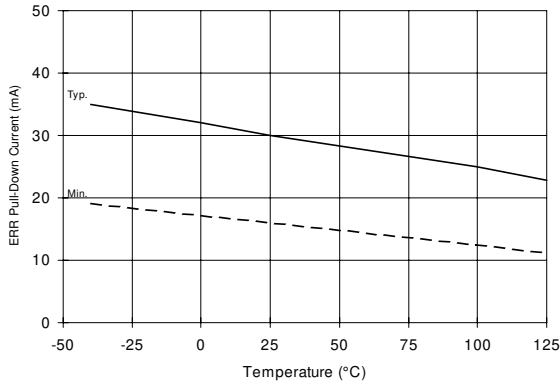

Figure 29A. ERR Pull-Down Current vs. Temperature

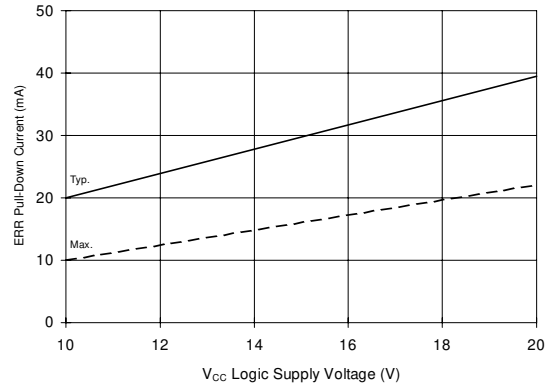

Figure 29B. ERR Pull-Down Current vs. Voltage

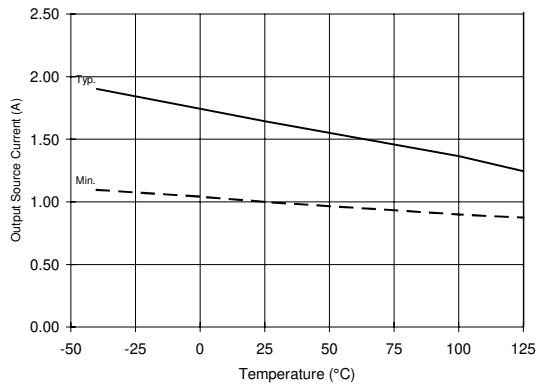

Figure 30A. Output Source Current vs. Temperature

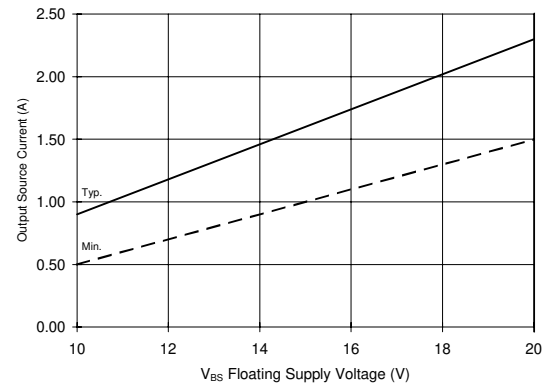

Figure 30B. Output Source Current vs. Voltage

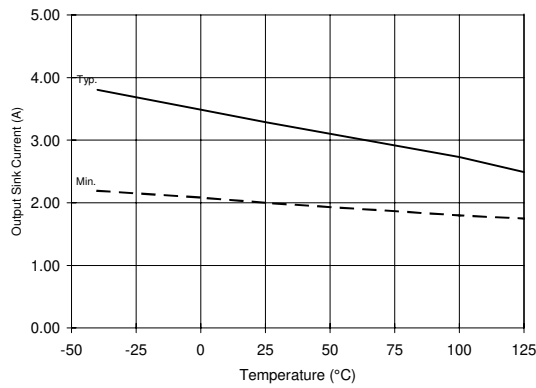

Figure 31A. Output Sink Current vs. Temperature

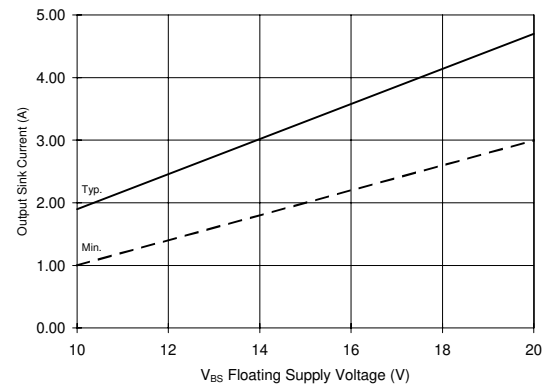

Figure 31B. Output Sink Current vs. Voltage

# IR2121 & (PbF)

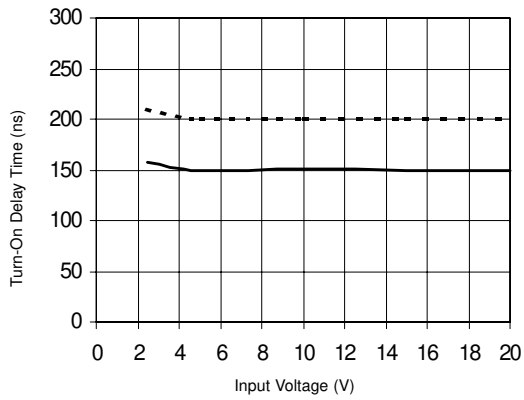

Figure 32A. Turn-On Time vs. Input Voltage

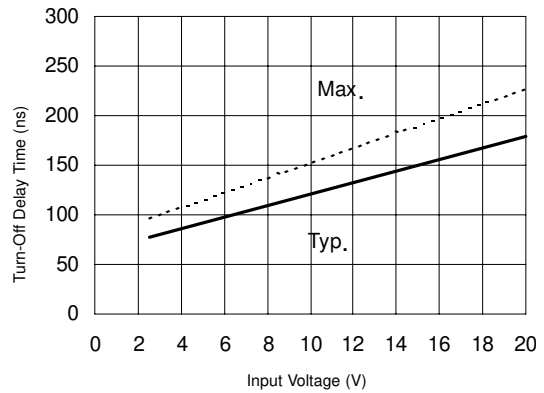

Figure 32B. Turn-Off Time vs. Input Voltage

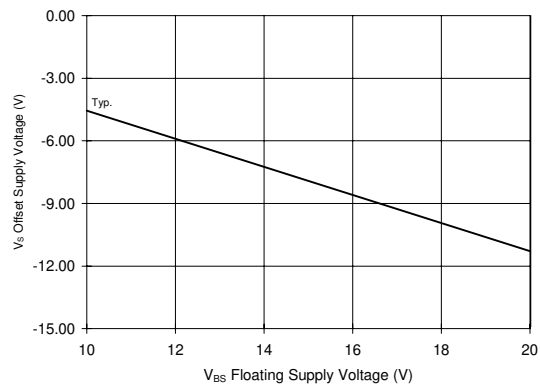
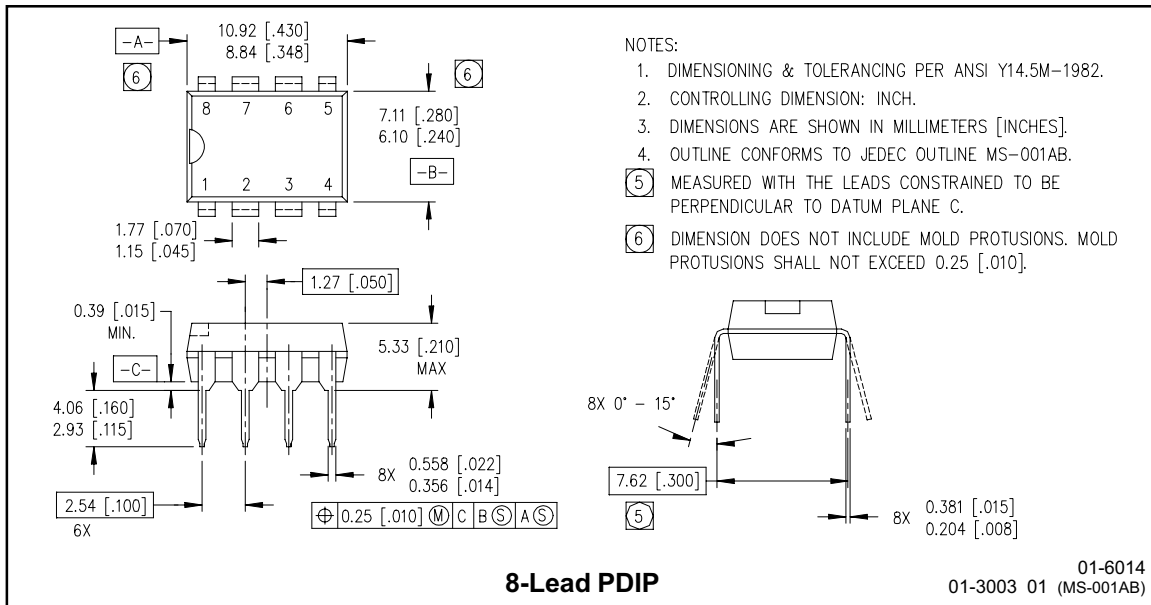

Figure 33. Maximum V<sub>S</sub> Negative Offset vs. Supply Voltage

## Case outline



# IR2121 & (PbF)

## LEADFREE PART MARKING INFORMATION

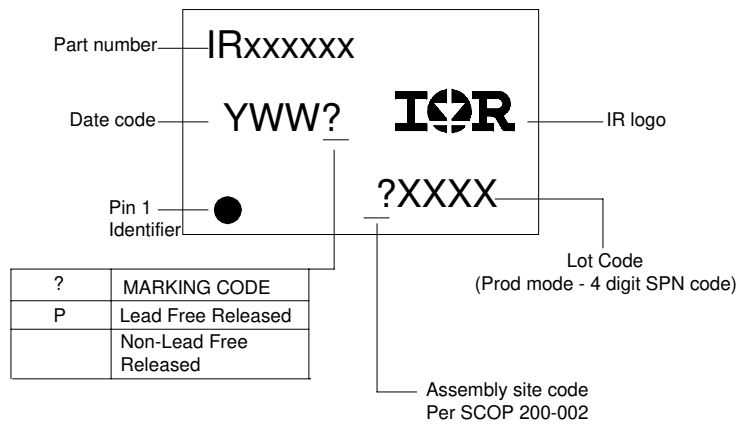

## ORDER INFORMATION

Basic Part (Non-Lead Free)  
8-Lead PDIP IR2121 order IR2121

Leadfree Part  
8-Lead PDIP IR2121 order IR2121PbF