

REVISIONS				
REV	DATE	DESCRIPTION	BY	APP'D
A1	22DEC2017	REVISED PER ECO-17-018762	J.Z	D.Z

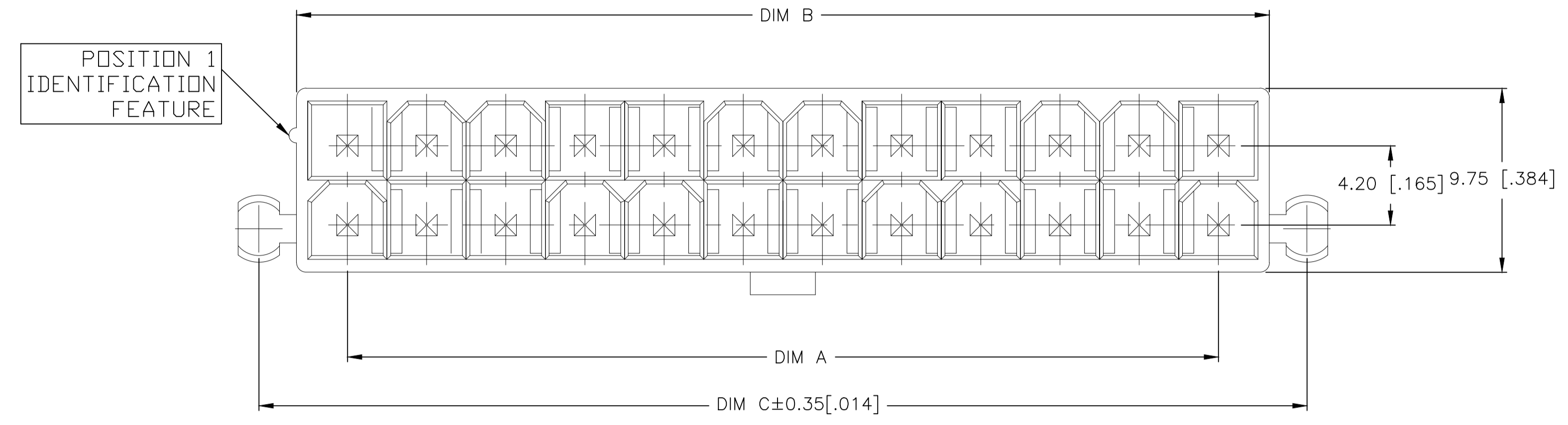

- 1 MATERIAL:
HOUSING: POLYAMIDE, UL94V-0, NATURAL
CONTACTS: HIGH PERFORMANCE COPPER ALLOY, TIN PLATED
- 2 GLOW WIRE APPROVED, CONTACT TE ENGINEERING FOR SPECIFICATION.
- 3 MATES WITH VAL-U-LOK(TM) RECEPTACLE HOUSINGS:
X-1586019-X(UL94-V0)
X-1586765-X(UL94-V2,GLOW WIRE)

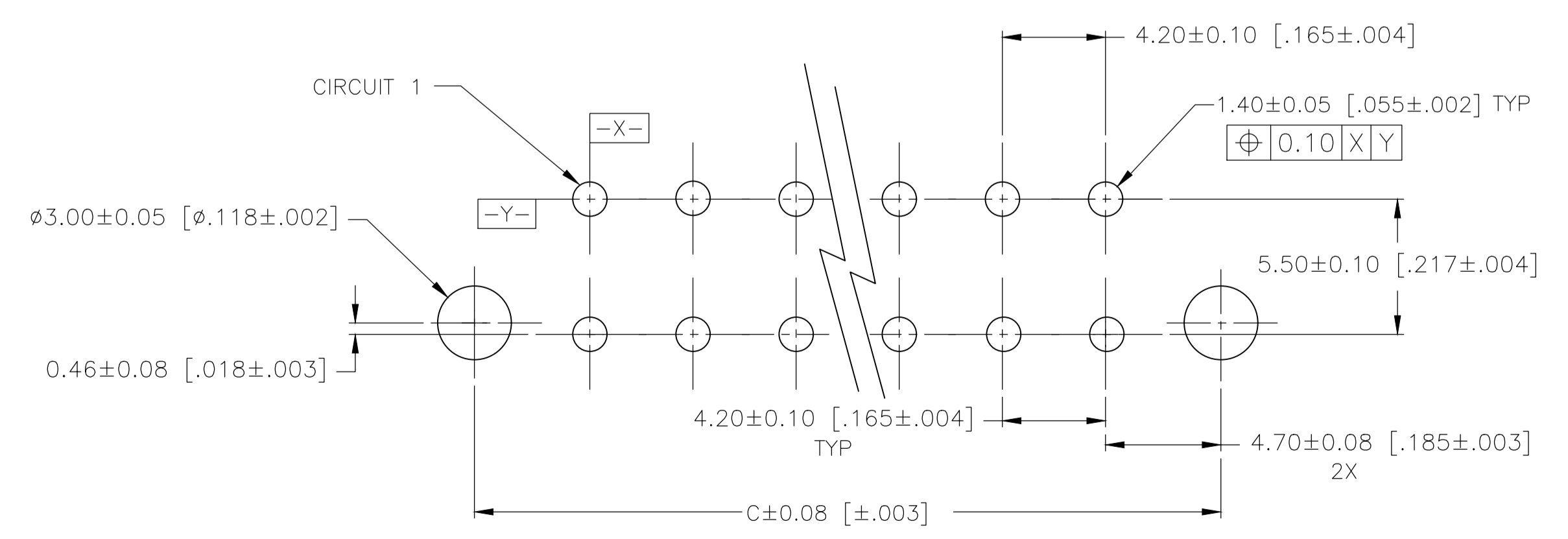
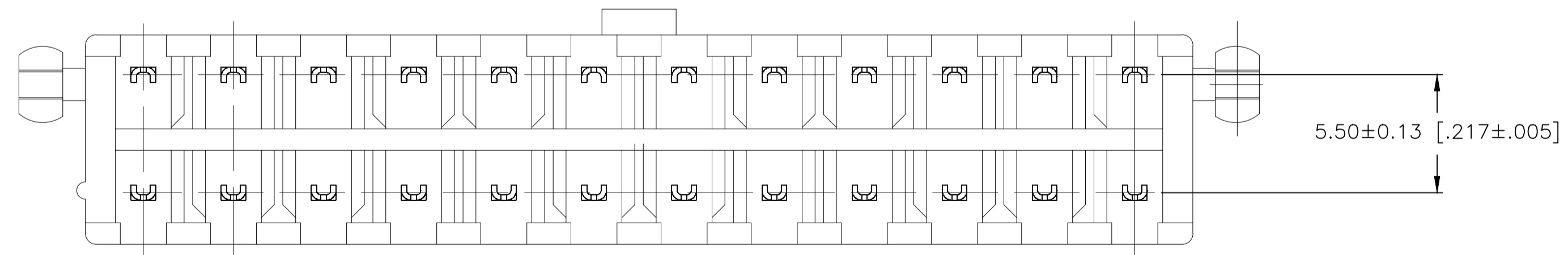
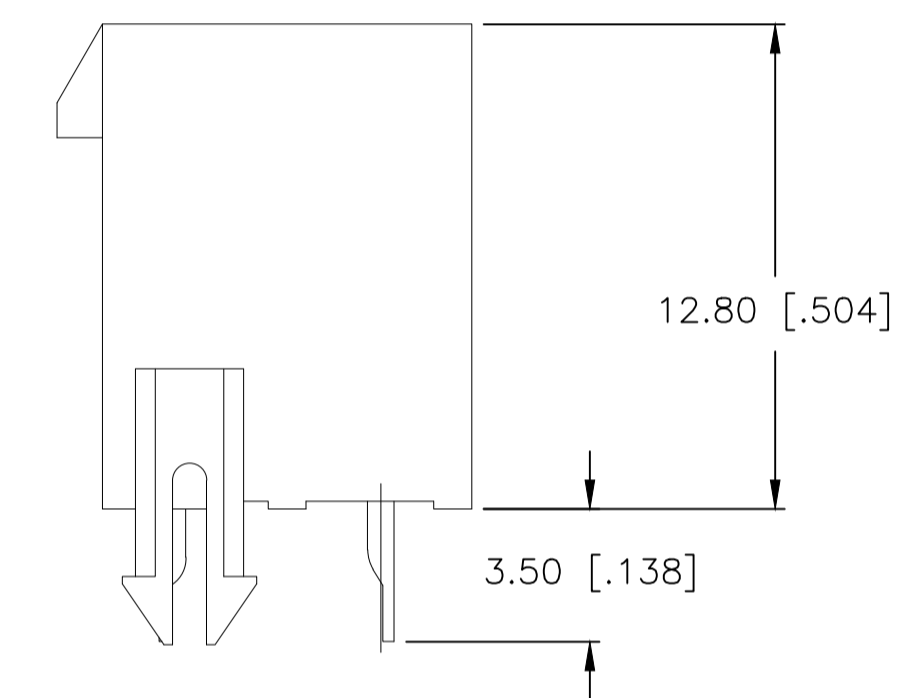
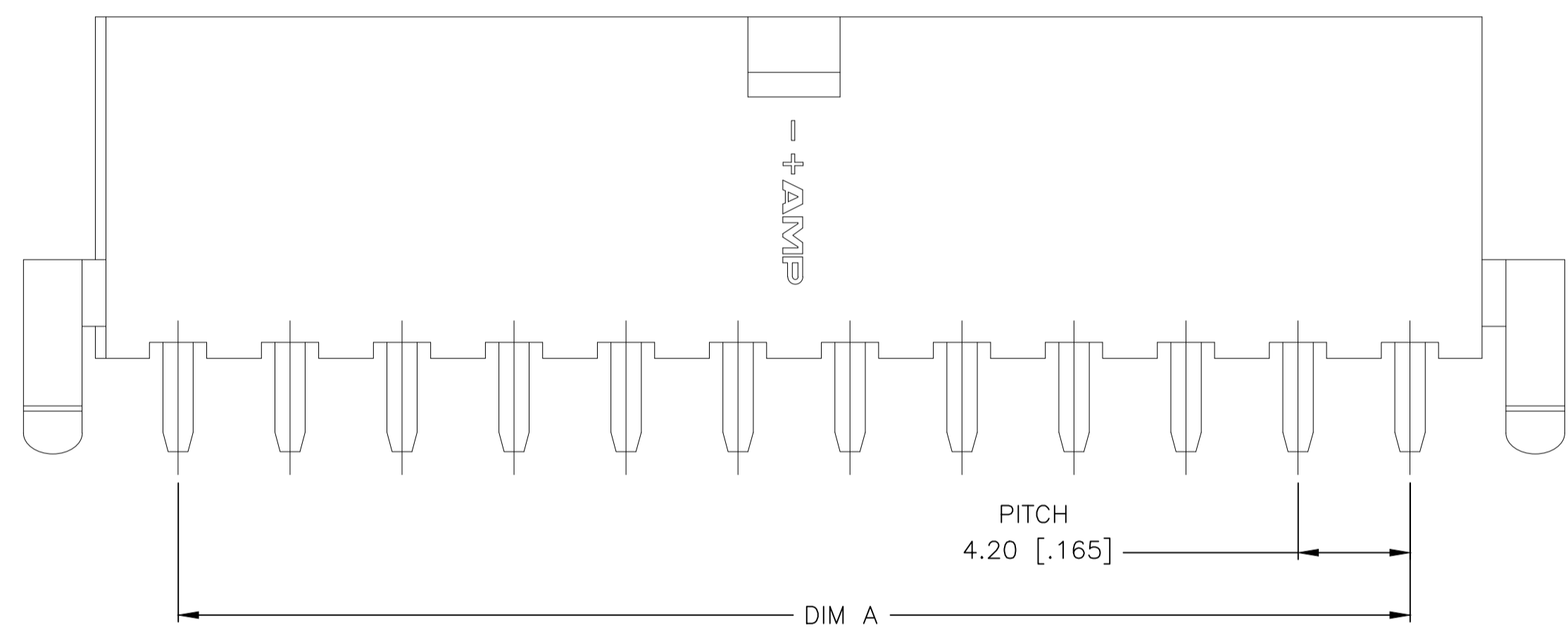
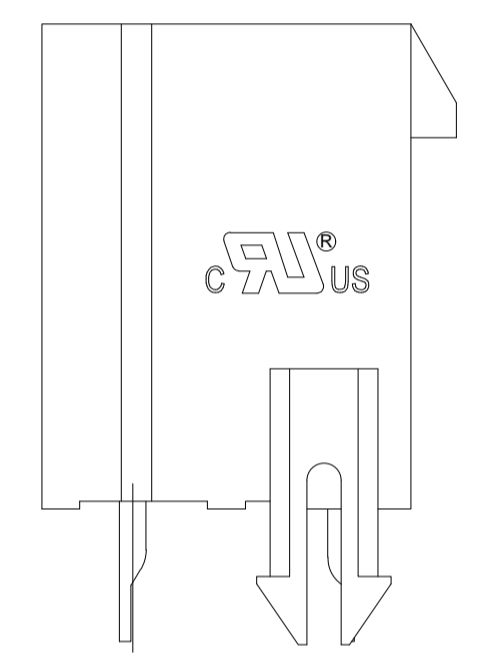

PCB LAYOUT: COMPONENT SIDE
RECOMMENDED BOARD THICKNESS 1.78 [.070]

POS	DIM A	DIM B	DIM C	PART NUMBER
24	46.2 ± 0.2 [1.819 ± .008]	51.6 ± 0.5 [2.031 ± 0.02]	55.6 [2.189]	2-2825274-4
22	42.0 ± 0.2 [1.654 ± .008]	47.4 ± 0.5 [1.866 ± 0.02]	51.4 [2.024]	2-2825274-2
20	37.8 ± 0.2 [1.488 ± .008]	43.2 ± 0.5 [1.701 ± 0.02]	47.2 [1.858]	2-2825274-0
18	33.6 ± 0.2 [1.323 ± .008]	39.0 ± 0.5 [1.536 ± 0.02]	43.0 [1.693]	1-2825274-8
16	29.4 ± 0.2 [1.157 ± .008]	34.8 ± 0.5 [1.370 ± 0.02]	38.8 [1.528]	1-2825274-6
14	25.2 ± 0.2 [.992 ± .008]	30.6 ± 0.5 [1.205 ± 0.02]	34.6 [1.362]	1-2825274-4
12	21.0 ± 0.2 [.827 ± .008]	26.4 ± 0.2 [1.039 ± .008]	30.4 [1.197]	1-2825274-2
10	16.8 ± 0.1 [.661 ± .004]	22.2 ± 0.2 [.874 ± .008]	26.2 [1.031]	1-2825274-0
8	12.6 ± 0.1 [.496 ± .004]	18.0 ± 0.2 [.709 ± .008]	22.0 [.866]	2825274-8
6	8.4 ± 0.1 [.331 ± .004]	13.8 ± 0.2 [.543 ± .008]	17.8 [.701]	2825274-6
4	4.2 ± 0.1 [.165 ± .004]	9.6 ± 0.2 [.378 ± .008]	13.6 [.535]	2825274-4
2		5.4 ± 0.2 [.213 ± .008]	9.4 [.370]	2825274-2

THIS DRAWING IS A CONTROLLED DOCUMENT.

DIMENSIONS: mm [INCHES]

TOLERANCES UNLESS OTHERWISE SPECIFIED:

0 PL	±	
1 PL	±	0.5 [0.2]
2 PL	±	0.25 [0.10]
3 PL	±	
4 PL	±	
ANGLES	±	

MATERIAL: 1

FINISH:

WARREN HUO 15AUG2017
DANIEL ZHANG 15AUG2017

DANIEL ZHANG 15AUG2017

NAME: VERTICAL HEADER WITH PEGS, WITHOUT DRAIN HOLES, VAL-U-LOK(TM), HCS

PRODUCT SPEC: 108-150000

APPLICATION SPEC: 114-13172

SIZE: A1

SCALE: N/A

SHEET: 1 OF 2

REV: A1

CUSTOMER DRAWING

SCALE: N/A

SHEET: 1 OF 2

REV: A1

REVISIONS				
#	LR	DESCRIPTION	DATE	OWN
-	-	SEE SHEET 1	-	-

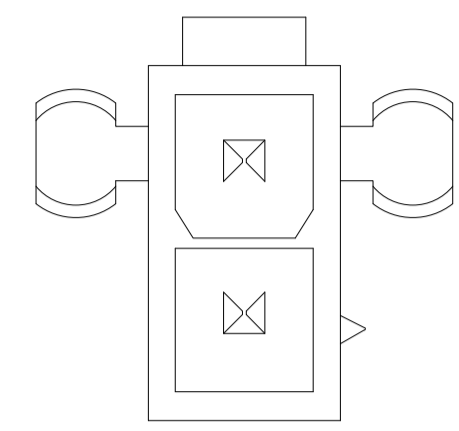

2825274-2

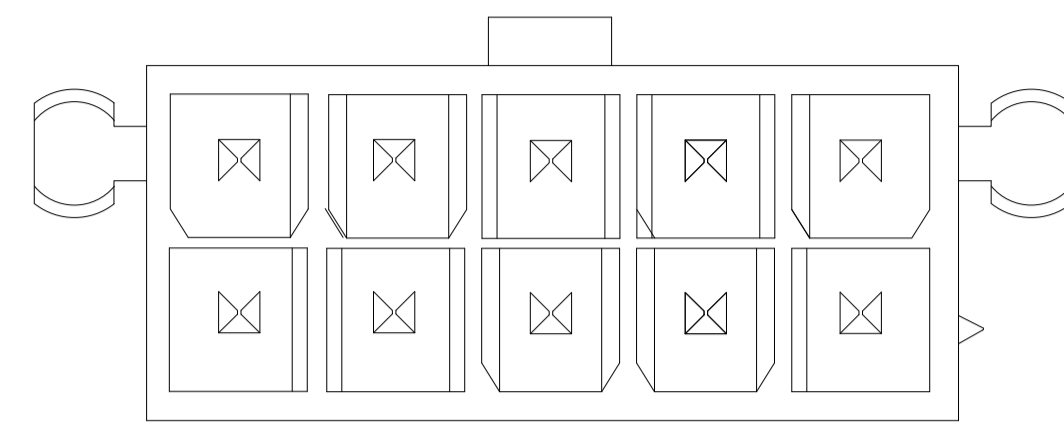

1-2825274-0

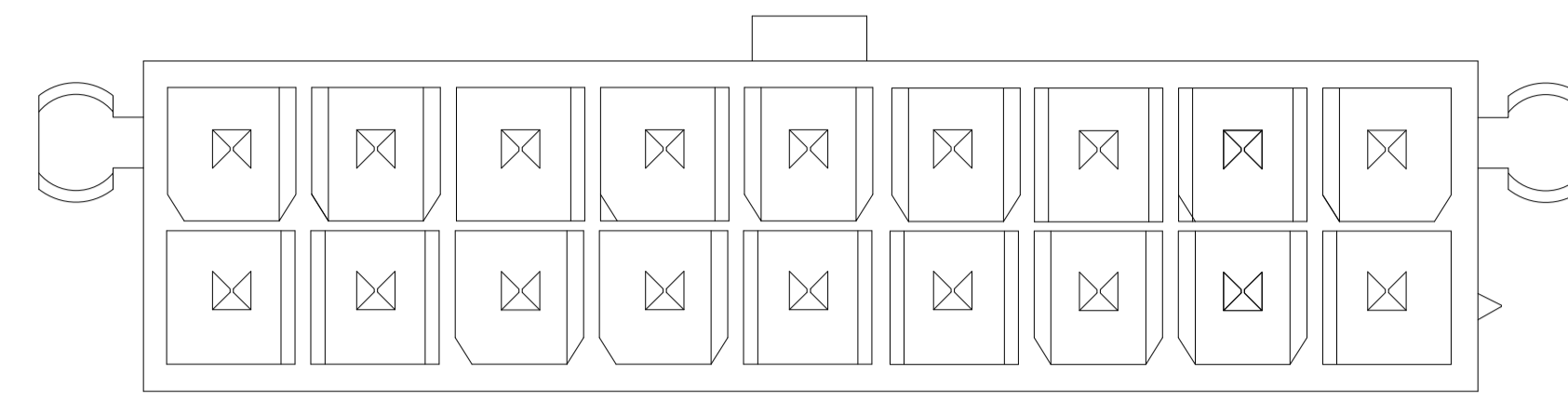

1-2825274-8

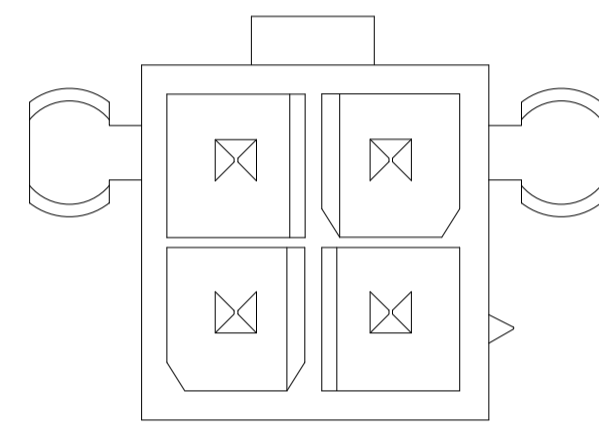

2825274-4

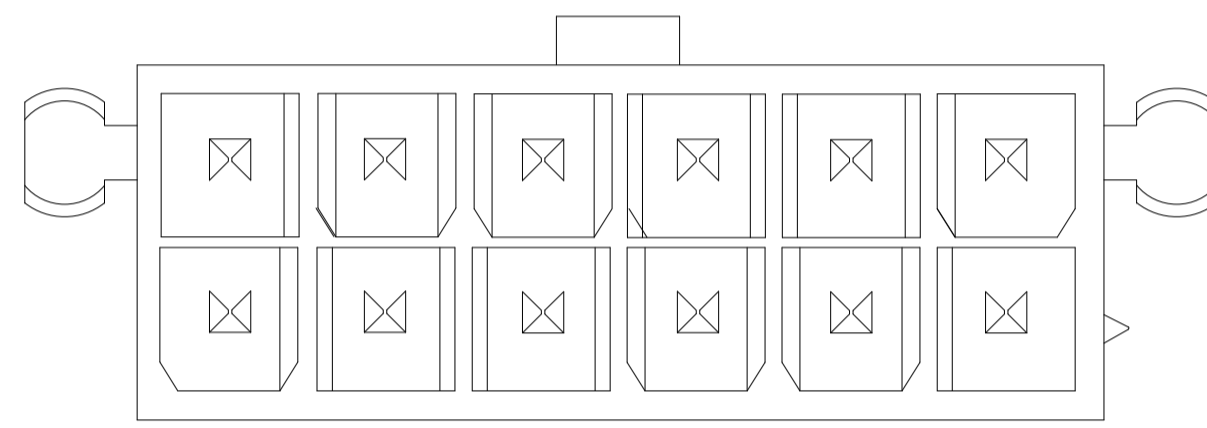

1-2825274-2

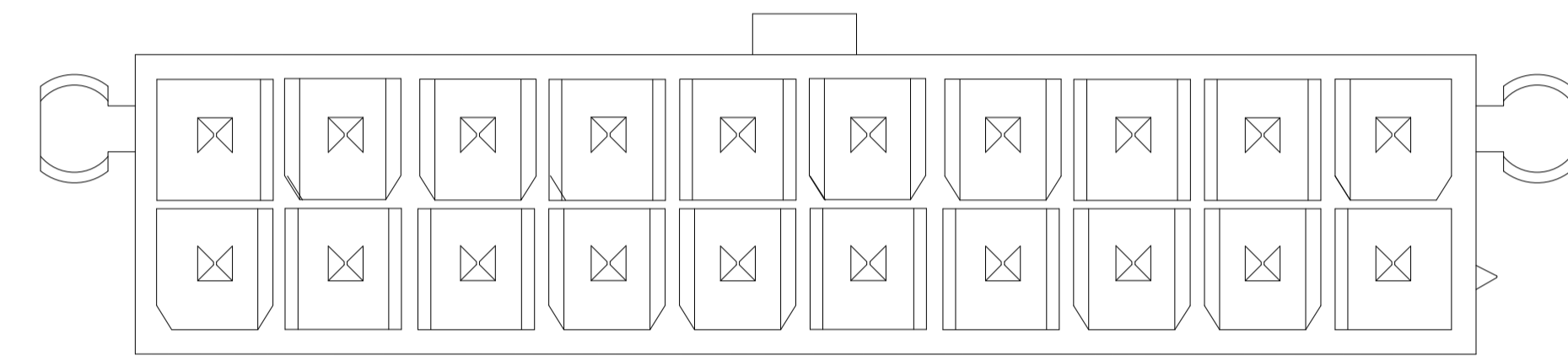

2-2825274-0

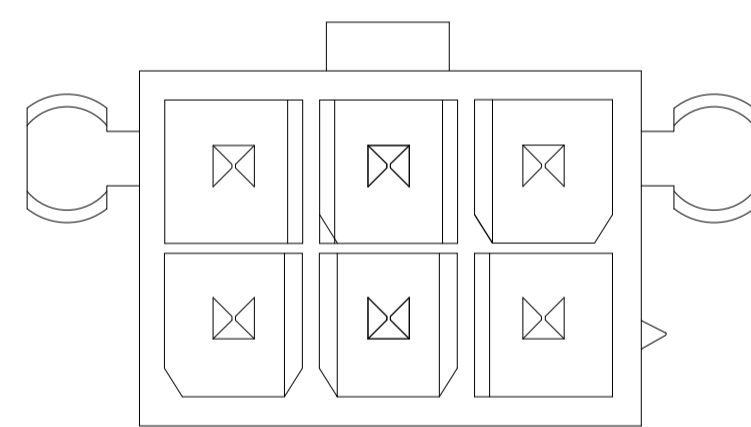

2825274-6

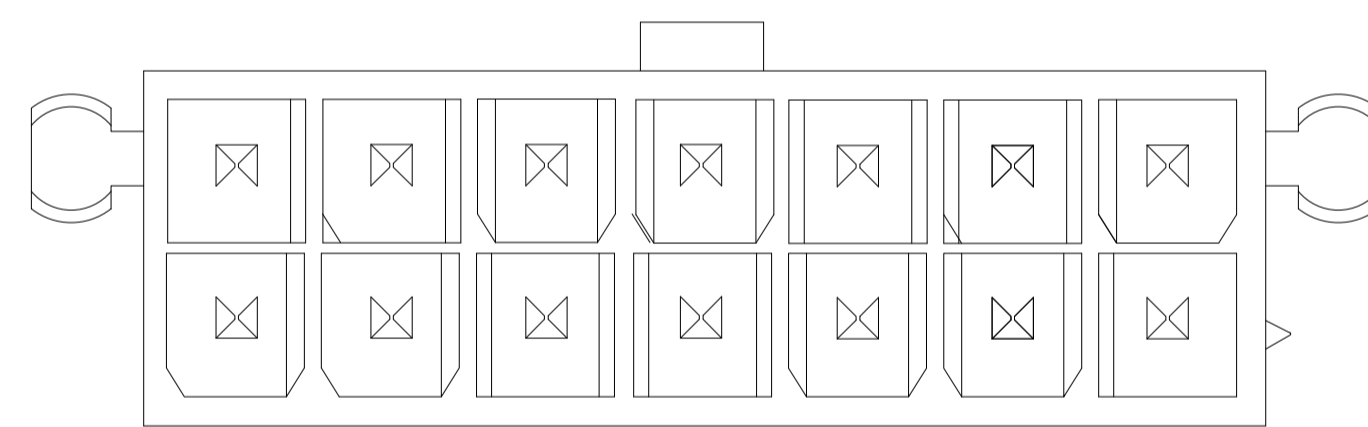

1-2825274-4

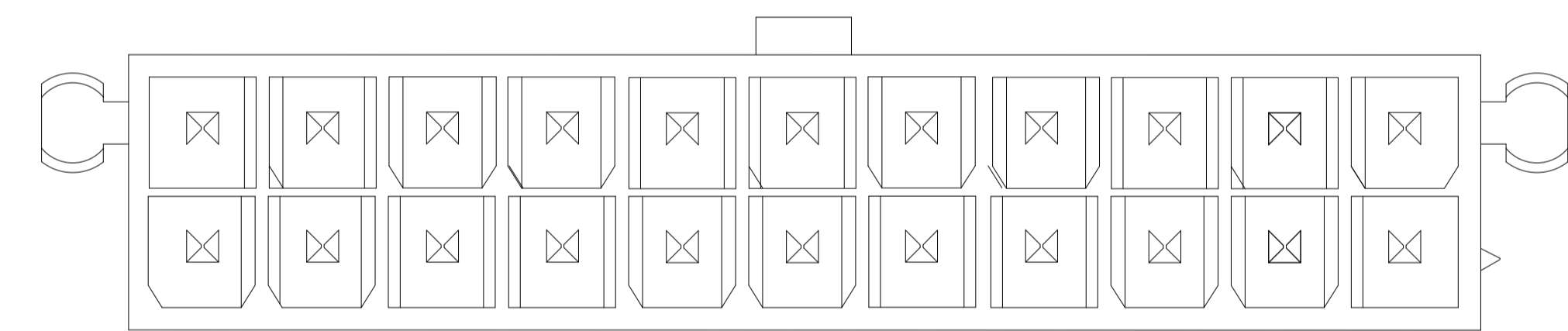

2-2825274-2

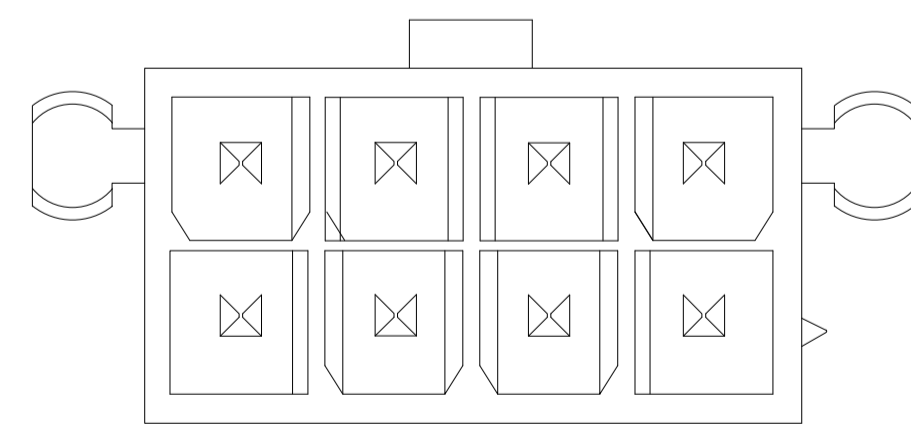

2825274-8

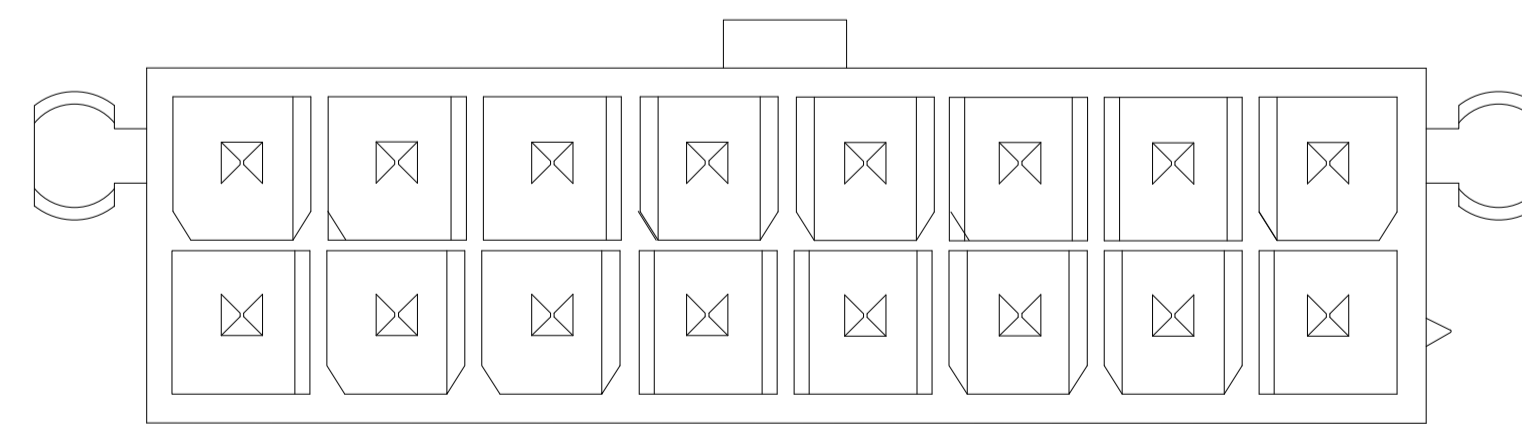

1-2825274-6

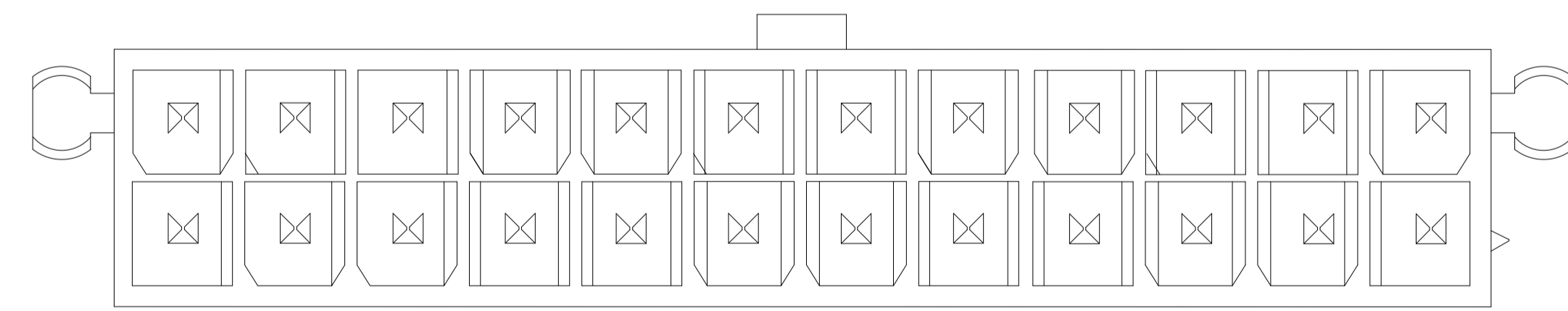

2-2825274-4

THIS DRAWING IS A CONTROLLED DOCUMENT.		DWN WARREN_HUO 15AUG2017	TE Connectivity	
DIMENSIONS: mm [INCHES]		CHK DANIEL_ZHANG 15AUG2017	NAME	
TOLERANCES UNLESS OTHERWISE SPECIFIED:		APRO DANIEL_ZHANG 15AUG2017	PRODUCT SPEC	
0 PLC ±		PRODUCT SPEC	108-150000	
1 PLC ± 0.5 [02]		APPLICATION SPEC	114-13172	
2 PLC ± 0.25 [010]		WEIGHT	A1 00779 ©=2825274	
3 PLC ±		CUSTOMER DRAWING	SCALE N/A SHEET 2 OF 2 REV A1	
4 PLC ±				
ANGLES ±				
FINISH				