

Sound Processors for AV Receiver Systems

# 7.1ch Sound Processor with Built-in Micro-step Volume

## BD34705KS2

### General description

The BD34705KS2 is an 8ch independent volume system. The system is designed to allow 7.1ch surround system application. It is improvement that sound quality more than the conventional products. Micro-step volume can reduce the switching pop noise during volume attenuation, so a high quality audio system could be achieved. 8ch triple input selectors for zone 3 and multi channel input enable the connection with a number of sources.

### Features

- 8ch input selectors  
(It is extendable to up to 14 by other functions and exclusion)
- Micro-step volume can reduce the switching pop noise during volume attenuation.
- Zone 3 is supported.
- Built-in 2ch Volume for ZONE output
- 2-wire serial bus control, corresponding to 3.3/5V.

### Applications

- Suitable for the AV receiver, home theater system, etc.

### Key Specifications

- Total harmonic distortion: 0.0004%(Typ.)
- Maximum output voltage: 4.2Vrms(Typ.)
- Output noise voltage: 1.2μVrms(Typ.)
- Residual output noise voltage: 1.0μVrms(Typ.)
- Cross-talk between channels: -105dB(Typ.)
- Cross-talk between selectors: -105dB(Typ.)

### Package

SQFP-T64

W(Typ.) x D(Typ.) x H(Max.)  
14.00mm x 14.00mm x 1.50mm



SQFP-T64

### Typical Application Circuit

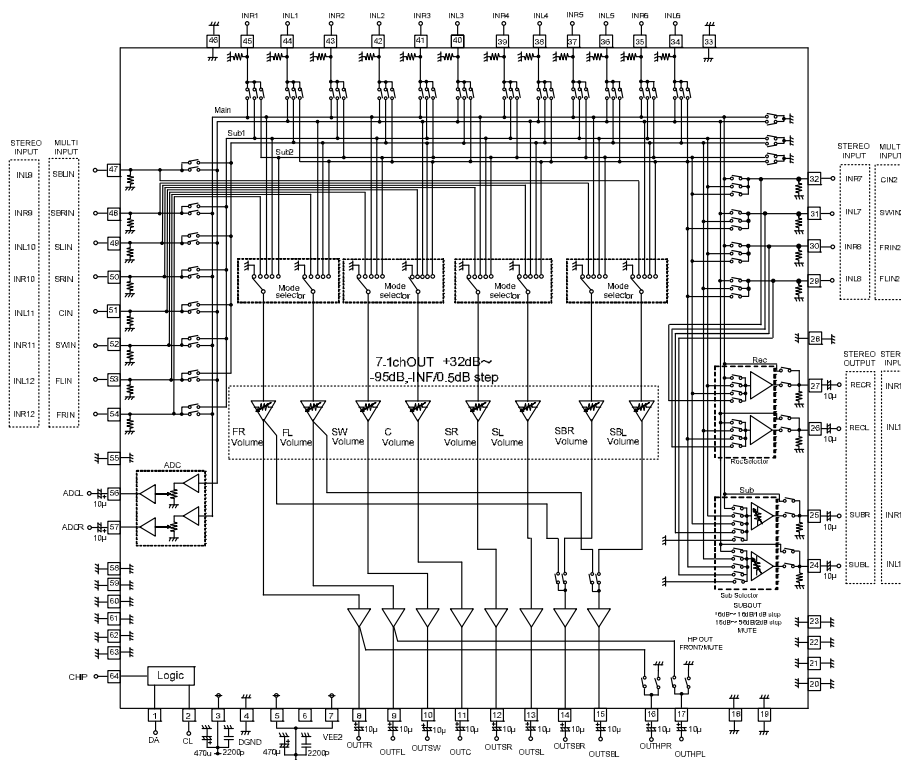

Figure 1. Application Circuit

○Product structure : Silicon monolithic integrated circuit ○This product is not designed protection against radioactive rays

www.rohm.com

© 2015 ROHM Co., Ltd. All rights reserved.  
TSZ22111 · 15 · 001

Pin Configuration

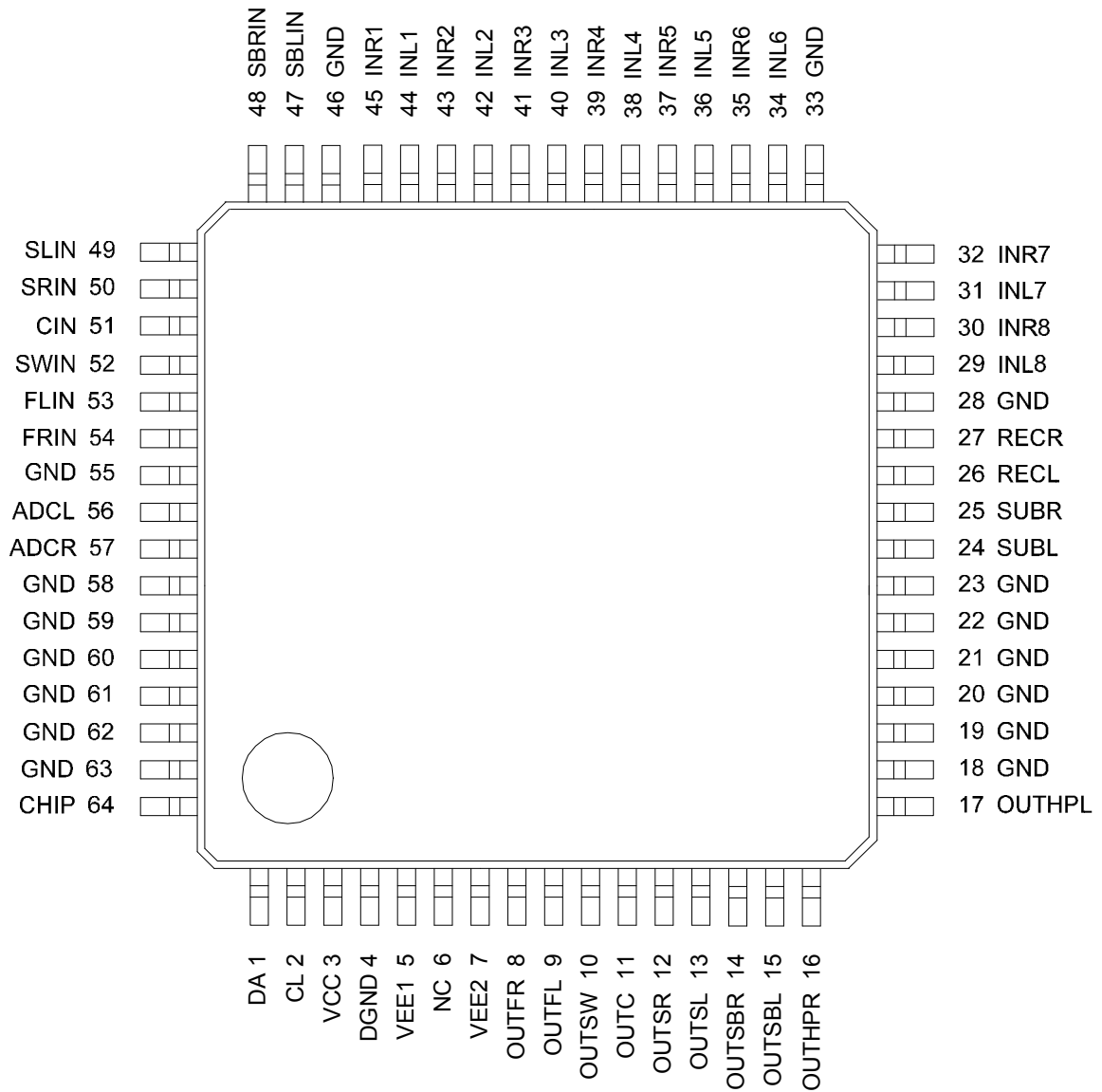

Figure 2. Pin Configuration

## Description of terminal

Terminal Number	Symbol	Function	Terminal Number	Symbol	Function
1	DA	Data and latch input terminal	33	GND	Analog ground terminal
2	CL	Clock input terminal	34	INL6	Lch input terminal 6
3	VCC	Positive power supply terminal	35	INR6	Rch input terminal 6
4	DGND	Digital ground terminal	36	INL5	Lch input terminal 5
5	VEE1	Negative power supply terminal 1	37	INR5	Rch input terminal 5
6	NC	No connect	38	INL4	Lch input terminal 4
7	VEE2	Negative power supply terminal 2	39	INR4	Rch input terminal 4
8	OUTFR	FRch Output terminal	40	INL3	Lch input terminal 3
9	OUTFL	FLch Output terminal	41	INR3	Rch input terminal 3
10	OUTSW	SWch Output terminal	42	INL2	Lch input terminal 2
11	OUTC	Cch Output terminal	43	INR2	Rch input terminal 2
12	OUTSR	SRch Output terminal	44	INL1	Lch input terminal 1
13	OUTSL	SLch Output terminal	45	INR1	Rch input terminal 1
14	OUTSBR	SBRch Output terminal	46	GND	Analog ground terminal
15	OUTSBL	SBLch Output terminal	47	SBLIN	SBLch DSP input terminal
16	OUTHPR	HPRch Output terminal	48	SBRLIN	SBRch DSP input terminal
17	OUTHPL	HPLch Output terminal	49	SLIN	SLch DSP input terminal
18	GND	Analog ground terminal	50	SRIN	SRch DSP input terminal
19	GND	Analog ground terminal	51	CIN	Cch DSP input terminal
20	GND	Analog ground terminal	52	SWIN	SWch DSP input terminal
21	GND	Analog ground terminal	53	FLIN	FLch DSP input terminal
22	GND	Analog ground terminal	54	FRIN	FRch DSP input terminal
23	GND	Analog ground terminal	55	GND	Analog ground terminal
24	SUBL	Lch SUB Output terminal	56	ADCL	Lch ADC Output terminal
25	SUBR	Rch SUB Output terminal	57	ADCR	Rch ADC Output terminal
26	RECL	Lch REC Output terminal	58	GND	Analog ground terminal
27	RECR	Rch REC Output terminal	59	GND	Analog ground terminal
28	GND	Analog ground terminal	60	GND	Analog ground terminal
29	INL8	Lch input terminal 8	61	GND	Analog ground terminal
30	INR8	Rch input terminal 8	62	GND	Analog ground terminal
31	INL7	Lch input terminal 7	63	GND	Analog ground terminal
32	INR7	Rch input terminal 7	64	CHIP	Chip select terminal

Block Diagram

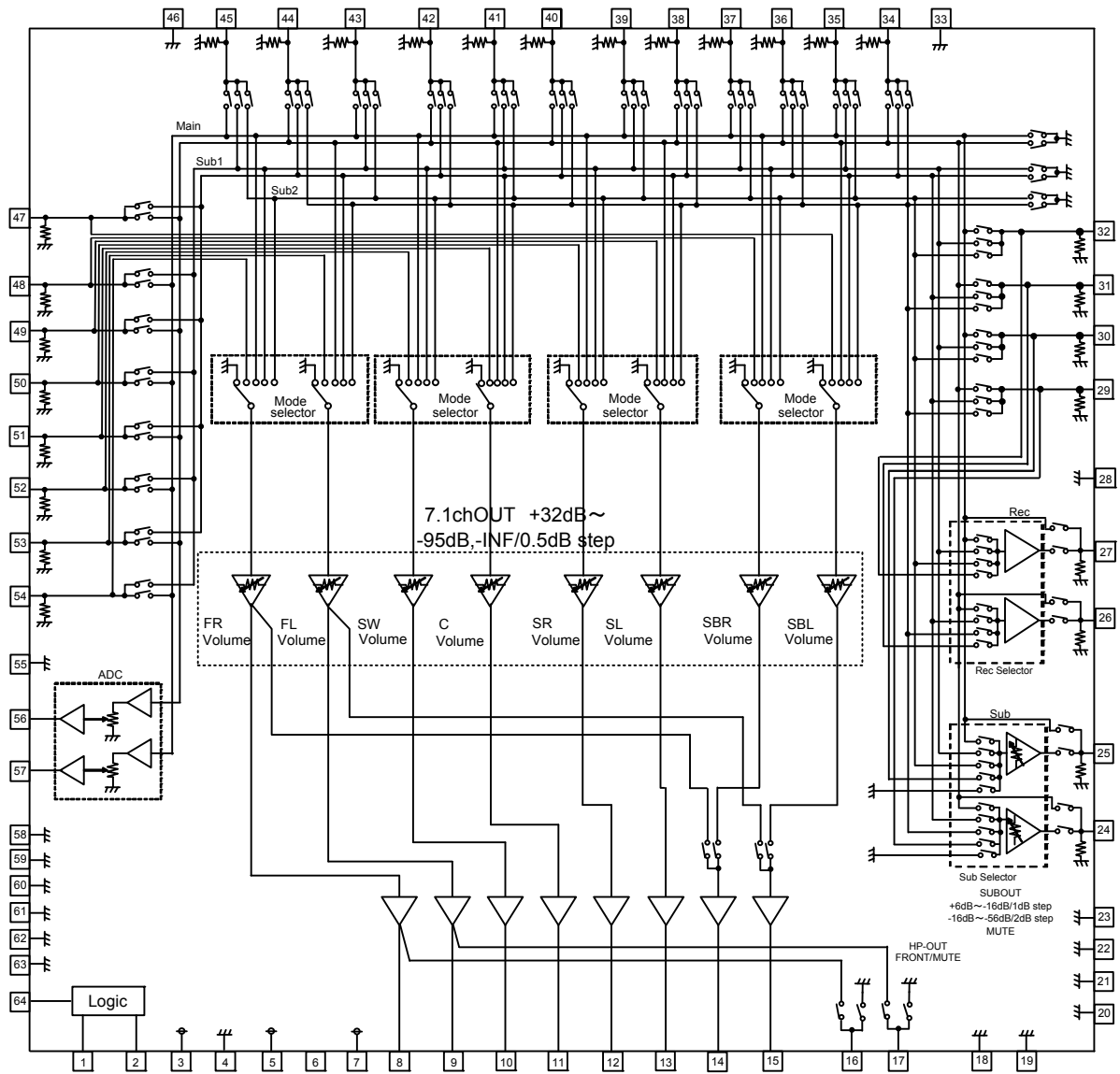

Figure 3. Block Diagram

**Absolute Maximum Ratings**

Item	Symbol	Rating	Unit
Positive power supply	VCC	+7.75 (Note1)	V
Negative power supply	VEE	-7.75 (Note1)	V
Power dissipation	Pd	1.50 (Note2)	W
Input voltage	Vin	VEE-0.2 to VCC+0.2	V
Operating temperature	Topr	-40 to +85 (Note3)	°C
Storage temperature	Tstg	-55 to +150	°C

(Note1) The maximum voltage that can be applied based on GND.

(Note2) Derating at 12.0mW/°C for operating above Ta≥25°C (mounted on 70×70×1.6mm ROHM standard board)

(Note3) If it is within the operation voltage range, circuit functions operation is guaranteed within operation temp.

**Caution:** Operating the IC over the absolute maximum ratings may damage the IC. The damage can either be a short circuit between pins or an open circuit between pins and the internal circuitry. Therefore, it is important to consider circuit protection measures, such as adding a fuse, in case the IC is operated over the absolute maximum ratings.

**Operating Condition**

Item	Symbol	Rating	Unit
Positive power supply	VCC	+6.5 to +7.5 (Note4,5)	V
Negative power supply	VEE	-6.5 to -7.5 (Note4,5)	V

(Note4) Applying voltage based on GND.

(Note5) Within the operating temperature range, basic circuit function and operation are guaranteed within this operation voltage range. But please confirm the setting of the constants, temperature, etc. Please take note that electrical characteristics other than defined values cannot be guaranteed, however original function will retain.

**Electrical characteristic**

Unless otherwise specified, Ta=25°C, VCC=7V, VEE=-7V, f=1kHz, Vin=1Vrms, RL=10kΩ,  
 Stereo input selector(MAIN, SUB1, SUB2)=IN1, Mode selector(FL, FRch)=MAIN,  
 Mode selector(SW, C, SL, SRch)=MULTI, Mode selector(SBL, SBRch)=MULTI, SB OUTSEL=SB,  
 Input Att=0dB, Input gain=0dB, Volume=0dB.

	Item	Symbol	Limit			Unit	Conditions
			Min.	Typ.	Max.		
TOTAL	Positive circuit current	Iqp	-	32	45	mA	No signal
	Negative circuit current	Iqn	-45	-32	-	mA	No signal
	Output voltage gain	Gv	-1.5	0	1.5	dB	8 to 15pin output
	Channel balance	CB	-0.5	0	0.5	dB	C Channel reference, 8 to 15pin output
	Total harmonic distortion	THD	-	0.0004	0.02	%	BW=400 to 30kHz 8 to 15pin output
	Maximum output voltage	Vom	3.8	4.2	-	Vrms	THD=1%, VOLUME=+10dB 8 to 15pin output
	Output noise voltage *	Vno	-	1.2	10	μVrms	Rg=0Ω, BW=IHF-A 8 to 15pin output
	Residual output noise voltage *	Vnor	-	1	8	μVrms	Volume=Mute, Rg=0Ω, BW=IHF-A 8 to 15pin output
	Cross-talk between channels *	CT	-	-105	-80	dB	Rg=0Ω, BW=IHF-A 8, 9pin output
	Cross-talk between selectors *	CS	-	-105	-80	dB	Rg=0Ω, BW=IHF-A 8, 9pin output
	Input impedance	Rin	32	47	62	kΩ	24 to 27, 29 to 32 34 to 35, 47 to 54 pin input
VOLUME	Maximum attenuation *	ATTmax	-	-115	-100	dB	Volume=Mute, BW=IHF-A
REC OUT	Total harmonic distortion	THDR	-	0.0005	0.02	%	BW=400 to 30kHz, RL=6.8kΩ 24 to 27pin output
HPOUT	Output impedance	Ron	520	800	1080	Ω	16,17pin output

※VP-9690(Average detection value, effective value display) filter by Panasonic is used for \* measurement.

Typical Performance Curve(s) (Reference data)

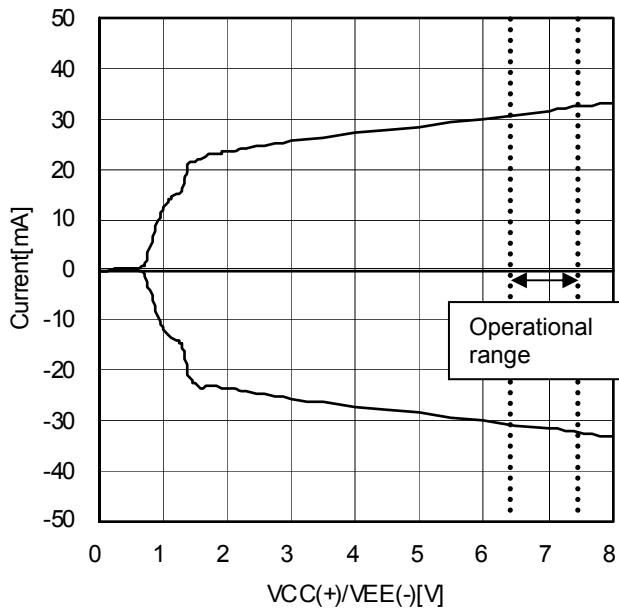

Figure 4. Circuit Currents vs. Circuit Voltage

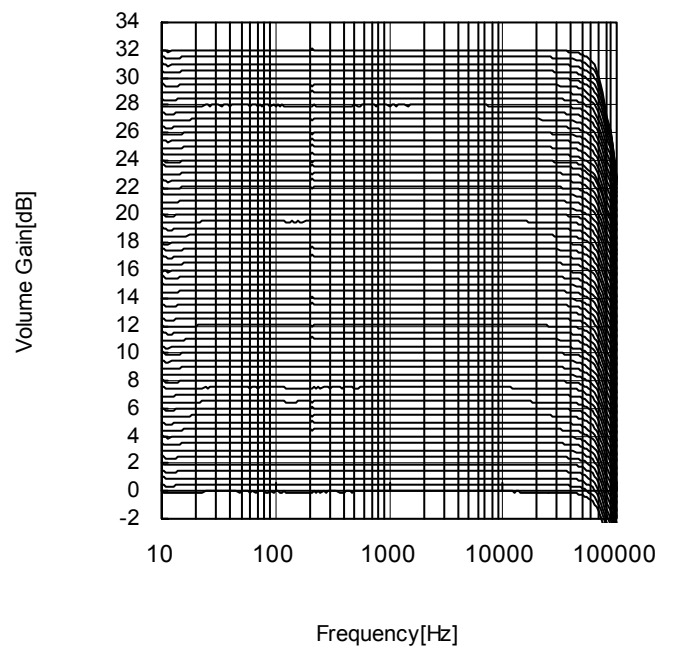

Figure 5. Volume Gain vs. Input Frequency (32dB to 0 dB setting)

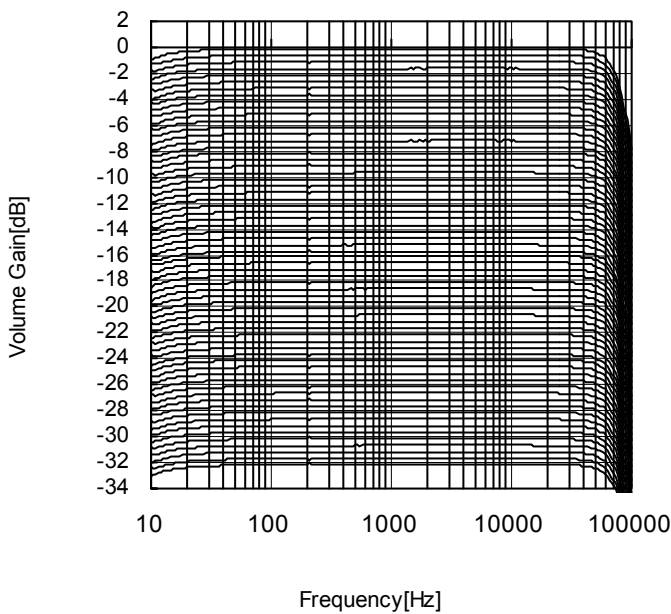

Figure 6. Volume Gain vs. Input Frequency (0dB to -32 dB setting)

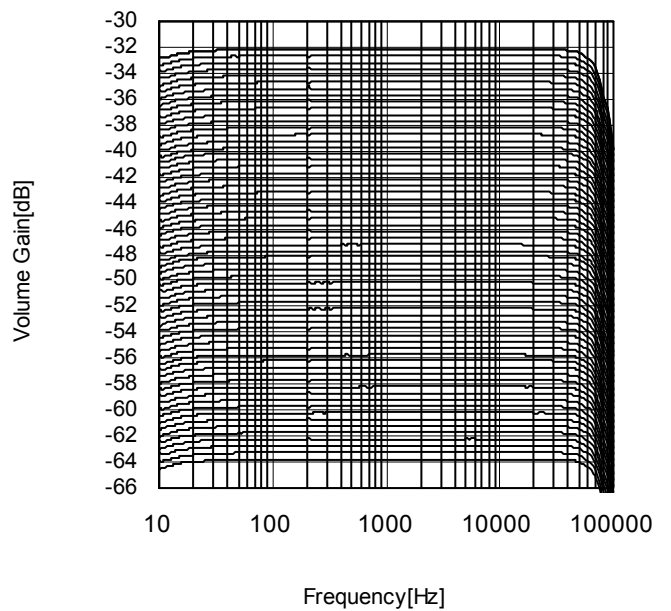

Figure 7. Volume Gain vs. Input Frequency (-32dB to -64 dB setting)

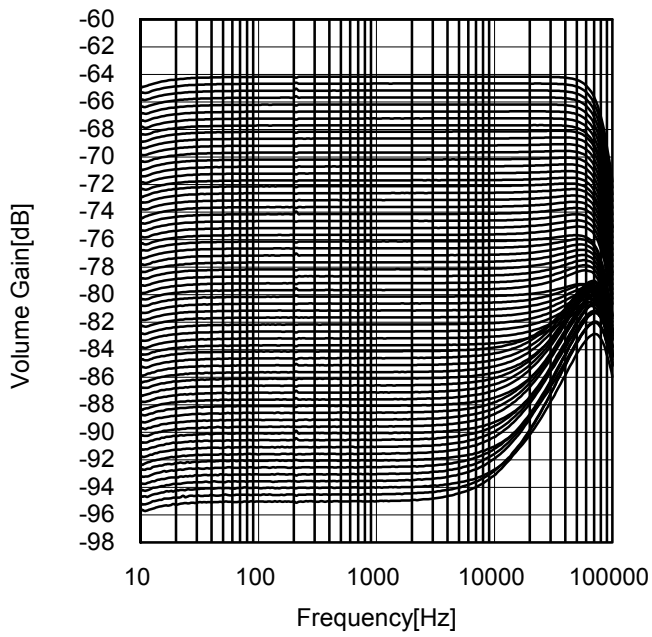

Figure 8. Volume Gain vs. Input Frequency (-64dB to -95 dB setting)

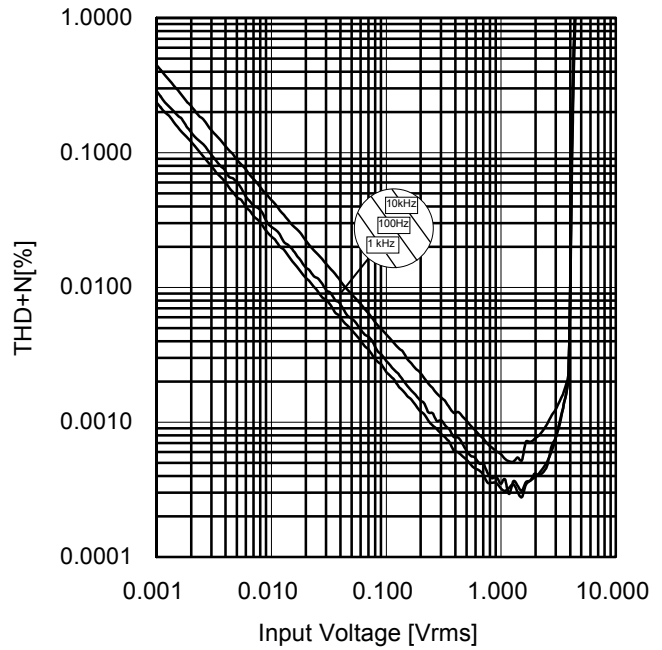

Figure 9. THD + N vs. Input Voltage

(Note) The measurement results of Figure 4 to Figure 8 used by 80kHz LPF.



**Specifications for Control Signal**

(1) Timing of control signal

Data is read at the rising edge of clock.

Latch is read at the falling edge of clock. Data on the latest 16bit is taken inside the IC.

Ensure to set DA and CL to LOW after Latch.

1byte=16bit

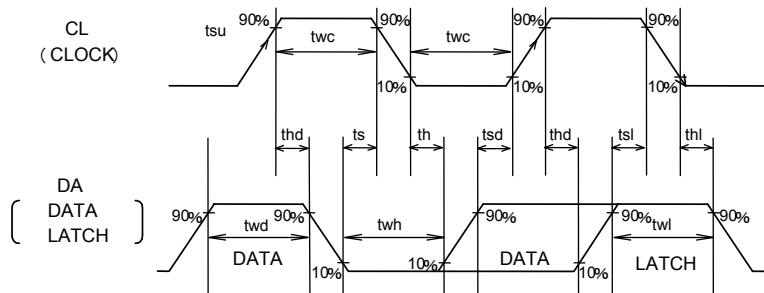

Figure 10. The timing definition of the control signal

Item	Symbol	Limit			Unit
		Min.	Typ.	Max.	
Clock width	twc	1.0	-	-	μsec
Data width	twd	1.0	-	-	μsec
Latch width	twl	1.0	-	-	μsec
Low hold width	twh	1.0	-	-	μsec
Data setup time (DATA→CLK)	tsd	0.5	-	-	μsec
Data hold time (CLK→DATA)	thd	0.5	-	-	μsec
Latch setup time (CLK→LATCH)	tsl	0.5	-	-	μsec
Latch hold time	thl	0.5	-	-	μsec
Latch Low setup time	ts	0.5	-	-	μsec
Latch Low hold time	th	0.5	-	-	μsec

(2) Voltage of control signal (CL, DA, CHIP)

Item	Conditions	Limit			Unit
		Min.	Typ.	Max. (<VCC)	
High input voltage	Vcc=+6.5 to +7.5V	2.3	-	5.5	V
Low input voltage	Vee=-6.5 to -7.5V	0	-	1.0	V

(3) Basic Structure of Control Data

← Input Direction

D15	D14	D13	D12	D11	D10	D9	D8	D7	D6	D5	D4	D3	D2	D1	D0
Data												Select Address			

(4) Table of Control Data

←Input Direction

Select Address No.	D15	D14	D13	D12	D11	D10	D9	D8	D7	D6	D5	D4	D3	D2	D1	D0	
0	Input Selector (MAIN)						REC ON/OFF	0	0	SUB ON/OFF	1	0	0	Chip Select	0	0	
1	Input Selector (SUB1)						0	0	Input Selector (SUB2)			0	0		1		
2	Mode Select FL, FRch		Mode Select C, SWch		Mode Select SL, SRch		Mode Select SBL, SBRch		0	ADC ATT			0		1	0	
3	Volume channel Select			Volume											0	1	1
4	0	HPOUT SEL	MSEL FRONT	MSEL C,SW	MSEL SUR	MSEL SURB	SB OUTSEL	SUB MUTE	0	0	0	0	1		0	0	
6	Mode Select REC		Mode Select SUB		1	Volume2						1	1		0		
7	A→B switch-time			B→A switch-time			Base Clock	0	0	System Reset	0	0	1		1	1	
													*	1	0	0	
													*	1	0	1	
													*	1	1	*	

BD3471KS2, BD3473KS2 and BD3474KS2 could be controlled using same serial control line.  
 (In case of using the serial bus as common, please set chip select as “1” )  
 BD3843FS, BD3841FS and BD3812F could be controlled using same serial control line.  
 (In case of using the serial bus as common, please set chip select as “0” )  
 All data need to be initialized every time when turning on the power supply.

(Example)

← Input direction

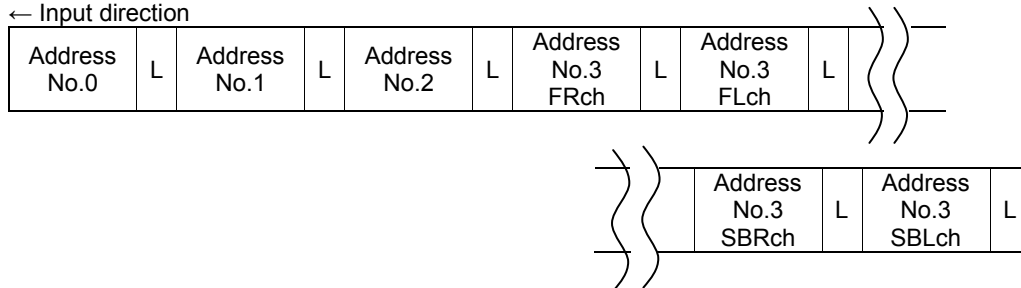

As for second time onwards, after turning on the power supply, sending data of any address could be changed.

(5) Chip Select Setting Table

CHIP terminal condition	D2
0 (LOW)	0
1 (HIGH)	1

BD34705KS2 can operate in combination with another by setting the CHIP terminal.

Select Address No.0 Setting Table

Function & Setting		D15	D14	D13	D12	D11	D10	D9	D8	D7	D6	D5	D4	D3	D2	D1	D0	
Input Selector (MAIN)	MUTE	0	0	0	0	0	0	Rec on/off	0	0	Sub on/off	1	0	0	Chip Select	0	0	
	IN1	0	0	0	0	0	1											
	IN2	0	0	0	0	1	0											
	IN3	0	0	0	0	1	1											
	IN4	0	0	0	1	0	0											
	IN5	0	0	0	1	0	1											
	IN6	0	0	0	1	1	0											
	IN7	0	0	0	1	1	1											
	IN8	0	0	1	0	0	0											
	IN9	0	0	1	0	0	1											
	IN10	0	0	1	0	1	0											
	IN11	0	0	1	0	1	1											
	IN12	0	0	1	1	0	0											
	IN13(REC)	0	0	1	1	0	1											
	IN14(SUB)	0	0	1	1	1	0											
Prohibition		0	1	0	0	0	0											
	⋮	⋮	⋮	⋮	⋮	⋮												
		1	1	1	1	1	1											
REC ON/OFF	OFF	Input Selector (MAIN)						0										
	ON							1										
SUB ON/OFF	OFF												0					
	ON												1					

 : Initial condition

Select Address No.1 Setting Table

Function & Setting	D15	D14	D13	D12	D11	D10	D9	D8	D7	D6	D5	D4	D3	D2	D1	D0	
Input Selector (SUB1)	MUTE	0	0	0	0	0	0	0	Input Selector (SUB2)				0	Chip Select	0	1	
	IN1	0	0	0	0	0											1
	IN2	0	0	0	0	1											0
	IN3	0	0	0	0	1											1
	IN4	0	0	0	1	0											0
	IN5	0	0	0	1	0											1
	IN6	0	0	0	1	1											0
	IN7	0	0	0	1	1											1
	IN8	0	0	1	0	0											0
	IN9	0	0	1	0	0											1
	IN10	0	0	1	0	1											0
	IN11	0	0	1	0	1											1
	IN12	0	0	1	1	0											0
	Prohibition	0	0	1	0	0											1
	∴	∴	∴	∴	∴	∴											
	1	1	1	1	1	1											
Input Selector (SUB2)	MUTE	Input Selector (SUB1)						0	0	0	0						
	IN1							0	0	0	1						
	IN2							0	0	1	0						
	IN3							0	0	1	1						
	IN4							0	1	0	0						
	IN5							0	1	0	1						
	IN6							0	1	1	0						
	IN7							0	1	1	1						
	IN8							1	0	0	0						
	Prohibition							1	0	0	1						
	∴	∴	∴	∴													
	1	1	1	1													

: Initial condition

Select Address No.2 Setting Table ※Select Address No.4 MSEL="0"(Front,C,SW,SR,SRB)

Function & Setting		D15	D14	D13	D12	D11	D10	D9	D8	D7	D6	D5	D4	D3	D2	D1	D0
Mode Selector FL, FRCh	MUTE	0	0	Mode Selector C, SWCh		Mode Selector SL, SRCh		Mode Selector SBL, SBRCh		0	ADC ATT			0	Chip Select	1	0
	MAIN	0	1														
	MULTI	1	0														
	SUB1	1	1														
Mode Selector C, SWCh	MUTE	Mode Selector FL, FRCh		0	0	Mode Selector SL, SRCh		Mode Selector SBL, SBRCh		0	ADC ATT			0	Chip Select	1	0
	MAIN			0	1												
	MULTI			1	0												
	SUB1			1	1												
Mode Selector SL, SRCh	MUTE	Mode Selector FL, FRCh		Mode Selector C, SWCh		0	0	Mode Selector SBL, SBRCh		0	ADC ATT			0	Chip Select	1	0
	MAIN					0	1										
	MULTI					1	0										
	SUB1					1	1										
Mode Selector SBL, SBRCh	MUTE	Mode Selector FL, FRCh		Mode Selector C, SWCh		Mode Selector SL, SRCh		0	0	0	ADC ATT			0	Chip Select	1	0
	MULTI							0	1								
	SUB1							1	0								
	MAIN							1	1								

Select Address No.2 Setting Table ※Select Address No.4 MSEL="1"(Front,C,SW,SR,SRB)

Function & Setting		D15	D14	D13	D12	D11	D10	D9	D8	D7	D6	D5	D4	D3	D2	D1	D0
Mode Selector FL, FRCh	MUTE	0	0	Mode Selector C, SWCh		Mode Selector SL, SRCh		Mode Selector SBL, SBRCh		0	ADC ATT			0	Chip Select	1	0
	SUB2	0	1														
Mode Selector C, SWCh	MUTE	Mode Selector FL, FRCh		0	0	Mode Selector SL, SRCh		Mode Selector SBL, SBRCh		0	ADC ATT			0	Chip Select	1	0
	SUB2			0	1												
Mode Selector SL, SRCh	MUTE	Mode Selector FL, FRCh		Mode Selector C, SWCh		0	0	Mode Selector SBL, SBRCh		0	ADC ATT			0	Chip Select	1	0
	SUB2					0	1										
Mode Selector SBL, SBRCh	MUTE	Mode Selector FL, FRCh		Mode Selector C, SWCh		Mode Selector SL, SRCh		0	0	0	ADC ATT			0	Chip Select	1	0
	SUB2							0	1								

Select Address No.2 Setting Table

Function & Setting		D15	D14	D13	D12	D11	D10	D9	D8	D7	D6	D5	D4	D3	D2	D1	D0
ADC ATT	MUTE	Mode Selector FL, FRCh		Mode Selector C, SWCh		Mode Selector SL, SRCh		Mode Selector SBL, SBRCh		0	0	0	0	0	Chip Select	1	0
	0dB										0	0	1				
	-6dB										0	1	0				
	-6.5dB										0	1	1				
	-7.5dB										1	0	0				
	-9dB										1	0	1				
	-12dB										1	1	0				
	Prohibition										1	1	1				

 : Initial condition

Select Address No.3 Setting Table

Function & Setting		D15	D14	D13	D12	D11	D10	D9	D8	D7	D6	D5	D4	D3	D2	D1	D0			
Volume channel Select	FL	0	0	0	Volume												0	Chip Select	1	1
	FR	0	0	1																
	SW	0	1	0																
	C	0	1	1																
	SL	1	0	0																
	SR	1	0	1																
	SBL	1	1	0																
	SBR	1	1	1																
Volume	MUTE	Volume Channel Select			1	1	1	1	1	1	1	1	1	0	Chip Select	1	1			
	Prohibition					1	1	1	1	1	1	1	0							
						⋮	⋮	⋮	⋮	⋮	⋮	⋮	⋮							
						0	1	0	0	0	0	0	1							
	+32.0dB					0	1	0	0	0	0	0	0							
	+31.5dB					0	0	1	1	1	1	1	1							
	+31.0dB					0	0	1	1	1	1	1	0							
	+30.5dB					0	0	1	1	1	1	0	1							
	+30.0dB					0	0	1	1	1	1	0	0							
	+29.5dB					0	0	1	1	1	0	1	1							
	+29.0dB					0	0	1	1	1	0	1	0							
	+28.5dB					0	0	1	1	1	0	0	1							
	+28.0dB					0	0	1	1	1	0	0	0							
	+27.5dB					0	0	1	1	0	1	1	1							
	+27.0dB					0	0	1	1	0	1	1	0							
	+26.5dB					0	0	1	1	0	1	0	1							
	+26.0dB					0	0	1	1	0	1	0	0							
	+25.5dB					0	0	1	1	0	0	1	1							
	+25.0dB					0	0	1	1	0	0	1	0							
	+24.5dB					0	0	1	1	0	0	0	1							
	+24.0dB					0	0	1	1	0	0	0	0							
	+23.5dB					0	0	1	0	1	1	1	1							
	+23.0dB					0	0	1	0	1	1	1	0							
	+22.5dB					0	0	1	0	1	1	0	1							
	+22.0dB					0	0	1	0	1	1	0	0							
	+21.5dB					0	0	1	0	1	0	1	1							
	+21.0dB					0	0	1	0	1	0	1	0							
	+20.5dB					0	0	1	0	1	0	0	1							
	+20.0dB					0	0	1	0	1	0	0	0							
	+19.5dB					0	0	1	0	0	1	1	1							
	+19.0dB					0	0	1	0	0	1	1	0							
	+18.5dB					0	0	1	0	0	1	0	1							
+18.0dB	0	0	1	0	0	1	0	0												
+17.5dB	0	0	1	0	0	0	1	1												
+17.0dB	0	0	1	0	0	0	1	0												
+16.5dB	0	0	1	0	0	0	0	1												
+16.0dB	0	0	1	0	0	0	0	0												
+15.5dB	0	0	0	1	1	1	1	1												

: Initial condition

Select Address No.3 Setting Table

Function & Setting		D15	D14	D13	D12	D11	D10	D9	D8	D7	D6	D5	D4	D3	D2	D1	D0			
Volume	+15.0dB	Volume Channel Select			1	0	0	0	1	1	1	1	0	0	Chip Select	1	1			
	+14.5dB					0	0	0	1	1	1	0	1							
	+14.0dB					0	0	0	1	1	1	0	0							
	+13.5dB					0	0	0	1	1	0	1	1							
	+13.0dB					0	0	0	1	1	0	1	0							
	+12.5dB					0	0	0	1	1	0	0	1							
	+12.0dB					0	0	0	1	1	0	0	0							
	+11.5dB					0	0	0	1	0	1	1	1							
	+11.0dB					0	0	0	1	0	1	1	0							
	+10.5dB					0	0	0	1	0	1	0	1							
	+10.0dB					0	0	0	1	0	1	0	0							
	+9.5dB					0	0	0	1	0	0	1	1							
	+9.0dB					0	0	0	1	0	0	1	0							
	+8.5dB					0	0	0	1	0	0	0	1							
	+8.0dB					0	0	0	1	0	0	0	0							
	+7.5dB					0	0	0	0	1	1	1	1							
	+7.0dB					0	0	0	0	1	1	1	0							
	+6.5dB					0	0	0	0	1	1	0	1							
	+6.0dB					0	0	0	0	1	1	0	0							
	+5.5dB					0	0	0	0	1	0	1	1							
	+5.0dB				0	0	0	0	1	0	1	0								
	+4.5dB				0	0	0	0	1	0	0	1								
	+4.0dB				0	0	0	0	1	0	0	0								
	+3.5dB				0	0	0	0	0	1	1	1								
	+3.0dB				0	0	0	0	0	1	1	0								
	+2.5dB				0	0	0	0	0	1	0	1								
	+2.0dB				0	0	0	0	0	1	0	0								
	+1.5dB				0	0	0	0	0	0	1	1								
	+1.0dB				0	0	0	0	0	0	1	0								
	+0.5dB				0	0	0	0	0	0	0	1								
	Prohibition				0	0	0	0	0	0	0	0								
	-0dB				0	0	0	0	0	0	0	0	0					0	0	0
	-0.5dB					0	0	0	0	0	0	0	0					1		
	-1.0dB					0	0	0	0	0	0	0	1					0		
	-1.5dB					0	0	0	0	0	0	0	1					1		
	-2.0dB					0	0	0	0	0	0	1	0					0		
	-2.5dB					0	0	0	0	0	0	1	0					1		
	-3.0dB					0	0	0	0	0	0	1	1					0		
	-3.5dB					0	0	0	0	0	0	1	1					1		
	-4.0dB					0	0	0	0	1	0	0	0							
-4.5dB	0	0	0	0		1	0	0	1											
-5.0dB	0	0	0	0		1	0	1	0											
-5.5dB	0	0	0	0		1	0	1	1											
-6.0dB	0	0	0	0		1	1	0	0											
-6.5dB	0	0	0	0		1	1	0	1											
-7.0dB	0	0	0	0		1	1	1	0											
-7.5dB	0	0	0	0		1	1	1	1											

Select Address No.3 Setting Table

Function & Setting	D15	D14	D13	D12	D11	D10	D9	D8	D7	D6	D5	D4	D3	D2	D1	D0
Volume	-8.0dB	Volume Channel Select	0	0	0	0	0	1	0	0	0	0	0	Chip Select	1	1
	-8.5dB				0	0	0	1	0	0	0	1				
	-9.0dB				0	0	0	1	0	0	1	0				
	-9.5dB				0	0	0	1	0	0	1	1				
	-10.0dB				0	0	0	1	0	1	0	0				
	-10.5dB				0	0	0	1	0	1	0	1				
	-11.0dB				0	0	0	1	0	1	1	0				
	-11.5dB				0	0	0	1	0	1	1	1				
	-12.0dB				0	0	0	1	1	0	0	0				
	-12.5dB				0	0	0	1	1	0	0	1				
	-13.0dB				0	0	0	1	1	0	1	0				
	-13.5dB				0	0	0	1	1	0	1	1				
	-14.0dB				0	0	0	1	1	1	0	0				
	-14.5dB				0	0	0	1	1	1	0	1				
	-15.0dB				0	0	0	1	1	1	1	0				
	-15.5dB				0	0	0	1	1	1	1	1				
	-16.0dB				0	0	1	0	0	0	0	0				
	-16.5dB				0	0	1	0	0	0	0	1				
	-17.0dB				0	0	1	0	0	0	1	0				
	-17.5dB				0	0	1	0	0	0	1	1				
	-18.0dB				0	0	1	0	0	1	0	0				
	-18.5dB				0	0	1	0	0	1	0	1				
	-19.0dB				0	0	1	0	0	1	1	0				
	-19.5dB				0	0	1	0	0	1	1	1				
	-20.0dB				0	0	1	0	1	0	0	0				
	-20.5dB				0	0	1	0	1	0	0	1				
	-21.0dB				0	0	1	0	1	0	1	0				
	-21.5dB				0	0	1	0	1	0	1	1				
	-22.0dB				0	0	1	0	1	1	0	0				
	-22.5dB				0	0	1	0	1	1	0	1				
	-23.0dB				0	0	1	0	1	1	1	0				
-23.5dB	0	0	1	0	1	1	1	1								
-24.0dB	0	0	1	1	0	0	0	0								
-24.5dB	0	0	1	1	0	0	0	1								
-25.0dB	0	0	1	1	0	0	1	0								
-25.5dB	0	0	1	1	0	0	1	1								
-26.0dB	0	0	1	1	0	1	0	0								
-26.5dB	0	0	1	1	0	1	0	1								
-27.0dB	0	0	1	1	0	1	1	0								
-27.5dB	0	0	1	1	0	1	1	1								
-28.0dB	0	0	1	1	1	0	0	0								
-28.5dB	0	0	1	1	1	0	0	1								
-29.0dB	0	0	1	1	1	0	1	0								
-29.5dB	0	0	1	1	1	0	1	1								
-30.0dB	0	0	1	1	1	1	0	0								
-30.5dB	0	0	1	1	1	1	0	1								
-31.0dB	0	0	1	1	1	1	1	0								



Select Address No.3 Setting Table

Function & Setting	D15	D14	D13	D12	D11	D10	D9	D8	D7	D6	D5	D4	D3	D2	D1	D0		
Volume	-31.5dB	Volume Channel Select	0	0	0	0	1	1	1	1	1	1	0	Chip Select	1	1		
	-32.0dB				0	1	0	0	0	0	0	0						
	-32.5dB				0	1	0	0	0	0	0	0					1	
	-33.0dB				0	1	0	0	0	0	0	1					0	
	-33.5dB				0	1	0	0	0	0	0	1					1	
	-34.0dB				0	1	0	0	0	0	1	0					0	
	-34.5dB				0	1	0	0	0	0	1	0					1	
	-35.0dB				0	1	0	0	0	0	1	1					0	
	-35.5dB				0	1	0	0	0	0	1	1					1	
	-36.0dB				0	1	0	0	1	0	0	0					0	
	-36.5dB				0	1	0	0	1	0	0	0					1	
	-37.0dB				0	1	0	0	1	0	1	0					0	
	-37.5dB				0	1	0	0	1	0	1	0					1	
	-38.0dB				0	1	0	0	1	1	1	0					0	
	-38.5dB				0	1	0	0	1	1	1	0					1	
	-39.0dB				0	1	0	0	1	1	1	1					0	
	-39.5dB				0	1	0	0	1	1	1	1					1	
	-40.0dB				0	1	0	1	0	0	0	0					0	
	-40.5dB				0	1	0	1	0	0	0	0					1	
	-41.0dB				0	1	0	1	0	0	0	1					0	
	-41.5dB				0	1	0	1	0	0	0	1					1	
	-42.0dB				0	1	0	1	0	1	0	1					0	0
	-42.5dB				0	1	0	1	0	1	0	1					0	1
	-43.0dB				0	1	0	1	0	1	0	1					1	0
	-43.5dB				0	1	0	1	0	1	0	1					1	1
	-44.0dB				0	1	0	1	1	1	0	0					0	0
	-44.5dB				0	1	0	1	1	1	0	0					0	1
	-45.0dB				0	1	0	1	1	1	0	1					0	0
	-45.5dB				0	1	0	1	1	1	0	1					1	1
	-46.0dB				0	1	0	1	1	1	1	0					0	0
	-46.5dB				0	1	0	1	1	1	1	0					0	1
	-47.0dB				0	1	0	1	1	1	1	1					1	0
	-47.5dB				0	1	0	1	1	1	1	1					1	1
	-48.0dB				0	1	1	0	0	0	0	0					0	0
-48.5dB	0	1	1	0	0	0	0	0	0	1								
-49.0dB	0	1	1	0	0	0	0	1	0	0								
-49.5dB	0	1	1	0	0	0	0	1	1	1								
-50.0dB	0	1	1	0	0	1	0	0	0	0								
-50.5dB	0	1	1	0	0	1	0	0	1	0								
-51.0dB	0	1	1	0	0	1	1	1	0	0								
-51.5dB	0	1	1	0	0	1	1	1	1	1								
-52.0dB	0	1	1	0	1	0	0	0	0	0								
-52.5dB	0	1	1	0	1	0	0	0	0	1								
-53.0dB	0	1	1	0	1	0	1	0	1	0								
-53.5dB	0	1	1	0	1	0	1	0	1	1								
-54.0dB	0	1	1	0	1	1	1	0	0	0								
-54.5dB	0	1	1	0	1	1	1	0	0	1								

Select Address No.3 Setting Table

Function & Setting	D15	D14	D13	D12	D11	D10	D9	D8	D7	D6	D5	D4	D3	D2	D1	D0	
Volume	Volume Channel Select			0	0	1	1	0	1	1	1	0	0	Chip Select	1	1	
					-55.5dB	0	1	1	0	1	1	1					1
					-56.0dB	0	1	1	1	0	0	0					0
					-56.5dB	0	1	1	1	0	0	0					1
					-57.0dB	0	1	1	1	0	0	1					0
					-57.5dB	0	1	1	1	0	0	1					1
					-58.0dB	0	1	1	1	0	1	0					0
					-58.5dB	0	1	1	1	0	1	0					1
					-59.0dB	0	1	1	1	0	1	1					0
					-59.5dB	0	1	1	1	0	1	1					1
					-60.0dB	0	1	1	1	1	0	0					0
					-60.5dB	0	1	1	1	1	0	0					1
					-61.0dB	0	1	1	1	1	0	1					0
					-61.5dB	0	1	1	1	1	0	1					1
					-62.0dB	0	1	1	1	1	1	0					0
					-62.5dB	0	1	1	1	1	1	0					1
					-63.0dB	0	1	1	1	1	1	1					0
					-63.5dB	0	1	1	1	1	1	1					1
					-64.0dB	1	0	0	0	0	0	0					0
					-64.5dB	1	0	0	0	0	0	0					1
					-65.0dB	1	0	0	0	0	0	1					0
					-65.5dB	1	0	0	0	0	0	1					1
					-66.0dB	1	0	0	0	0	1	0					0
					-66.5dB	1	0	0	0	0	1	0					1
					-67.0dB	1	0	0	0	0	1	1					0
					-67.5dB	1	0	0	0	0	1	1					1
					-68.0dB	1	0	0	0	1	0	0					0
					-68.5dB	1	0	0	0	1	0	0					1
					-69.0dB	1	0	0	0	1	0	1					0
					-69.5dB	1	0	0	0	1	0	1					1
					-70.0dB	1	0	0	0	1	1	0					0
					-70.5dB	1	0	0	0	1	1	0					1
					-71.0dB	1	0	0	0	1	1	1					0
					-71.5dB	1	0	0	0	1	1	1					1
					-72.0dB	1	0	0	1	0	0	0					0
					-72.5dB	1	0	0	1	0	0	0					1
					-73.0dB	1	0	0	1	0	0	1					0
					-73.5dB	1	0	0	1	0	0	1					1
					-74.0dB	1	0	0	1	0	1	0					0
					-74.5dB	1	0	0	1	0	1	0					1
-75.0dB	1	0	0	1	0	1	1	0									
-75.5dB	1	0	0	1	0	1	1	1									
-76.0dB	1	0	0	1	1	0	0	0									
-76.5dB	1	0	0	1	1	0	0	1									
-77.0dB	1	0	0	1	1	0	1	0									
-77.5dB	1	0	0	1	1	0	1	1									
-78.0dB	1	0	0	1	1	1	0	0									



Select Address No.4 Setting Table ※ON/OFF of each MSEL is reflected by Address No. 2 mode selector

Function & Setting		D15	D14	D13	D12	D11	D10	D9	D8	D7	D6	D5	D4	D3	D2	D1	D0	
HPOUT SEL	MUTE	0	0	MSEL FRONT	MSEL C,SW	MSEL SUR	MSEL SURB	SB SELECT	SUB MUTE	0	0	0	0	0	Chip Select	1	1	
	FRONT		1															
MSEL FRONT	OFF		HPOUT SEL	0														1
	ON																	
MSEL C,SW	OFF		MSEL FRONT	0														1
	ON																	
MSEL SUR	OFF		MSEL C,SW	0														1
	ON																	
MSEL SURB	OFF		MSEL SUR	0														1
	ON																	
SB Select	SURB		MSEL SURB	0														1
	FRONT																	
SUB MUTE	OFF		SB SELECT	0														1
	ON																	

Select Address No.6 Setting Table

Function & Setting		D15	D14	D13	D12	D11	D10	D9	D8	D7	D6	D5	D4	D3	D2	D1	D0																							
Mode Selector REC	MAIN	0	0	Mode Selector SUB	1	1	1	Volume2						1	Chip Select	1	0																							
	SUB1	0	1																																					
	SUB2	1	0																																					
	MULTI	1	1																																					
Mode Selector SUB	MAIN	Mode Selector REC	0	1	0			0	0	1	1	1	1					1	1	1	1	1	1																	
	SUB1				0			1																																
	SUB2				1			0																																
	MULTI				1			1																																
Volume2	MUTE	Mode Selector REC	0	1	1			0																1	1	1	1	1	1	1	1	1	1	1						
	Prohibition																																		1	1	1	1	1	0
																																			⋮	⋮	⋮	⋮	⋮	⋮
																																			0	0	0	1	1	1
	+6.0dB																																		0	0	0	1	1	0
	+5.0dB																																		0	0	0	1	0	1
	+4.0dB																																		0	0	0	1	0	0
	+3.0dB																																		0	0	0	0	1	1
	+2.0dB					0	0							0	0	1	0																							
	+1.0dB					0	0							0	0	0	1																							
	+0.0dB					0	0							0	0	0	0																							
	-1.0dB					0	0							0	0	0	1																							
	-2.0dB					0	0		0	0	1	0																												
	-3.0dB					0	0		0	0	1	1																												
-4.0dB	0	0	0	1	0	0																																		
-5.0dB	0	0	0	1	0	1																																		

Select Address No.6 Setting Table

Function & Setting	D15	D14	D13	D12	D11	D10	D9	D8	D7	D6	D5	D4	D3	D2	D1	D0	
Volume2	Mode Selector REC				1	0	0	0	0	1	1	0	1	Chip Select	1	0	
							-6.0dB	0	0	0	1	1					0
							-7.0dB	0	0	0	1	1					1
							-8.0dB	0	0	1	0	0					0
							-9.0dB	0	0	1	0	0					1
							-10.0dB	0	0	1	0	1					0
							-11.0dB	0	0	1	0	1					1
							-12.0dB	0	0	1	1	0					0
							-13.0dB	0	0	1	1	0					1
							-14.0dB	0	0	1	1	1					0
							-15.0dB	0	0	1	1	1					1
							-16.0dB	0	1	0	0	0					0
							-18.0dB	0	1	0	0	0					1
							-20.0dB	0	1	0	0	1					0
							-22.0dB	0	1	0	0	1					1
							-24.0dB	0	1	0	1	0					0
							-26.0dB	0	1	0	1	0					1
							-28.0dB	0	1	0	1	1					0
							-30.0dB	0	1	0	1	1					1
							-32.0dB	0	1	1	0	0					0
							-34.0dB	0	1	1	0	0					1
							-36.0dB	0	1	1	0	1					0
							-38.0dB	0	1	1	0	1					1
							-40.0dB	0	1	1	1	0					0
							-42.0dB	0	1	1	1	0					1
							-44.0dB	0	1	1	1	1					0
							-46.0dB	0	1	1	1	1					1
-48.0dB	1	0	0	0	0	0											
-50.0dB	1	0	0	0	0	1											
-52.0dB	1	0	0	0	1	0											
-54.0dB	1	0	0	0	1	1											
-56.0dB	1	0	0	1	0	0											
Prohibition							1	0	0	1	0	1					
							∴	∴	∴	∴	∴	∴					
							1	1	1	1	1	1					

Select Address No.7 Setting Table

Function & Setting		D15	D14	D13	D12	D11	D10	D9	D8	D7	D6	D5	D4	D3	D2	D1	D0
A→B switching-time	11msec	0	0	0	B→A switching-time			Base Clock	0	0	System Reset	0	0	1	Chip Select	1	1
	5msec	0	0	1													
	7msec	0	1	0													
	14msec	0	1	1													
	3msec	1	0	0													
	2msec	1	0	1													
	Prohibition	1	1	0													
B→A switching-time	11msec	A→B switching-time			0	0	0	0	0	System Reset	0	0	1	Chip Select	1	1	
	5msec				0	0	1										
	7msec				0	1	0										
	14msec				0	1	1										
	3msec				1	0	0										
	2msec				1	0	1										
	Prohibition				1	1	0										
Base Clock	x1	B→A switching-time			0			0									
	x1/2							1									
System Reset	Normal	B→A switching-time			Base Clock			0									
	Reset							1									

: Initial condition

Select Address No.7, Data = D15-D13 : Below A → B switching time is adjustable.  
 Select Address No.7, Data = D12-D10 : Below B → A switching time is adjustable.

- ※Switching time over 11.2msec is recommended for both A→B and B→A.
- ※Set to same switching time for both A→B, B→A is recommended if the switching times need to be changed.

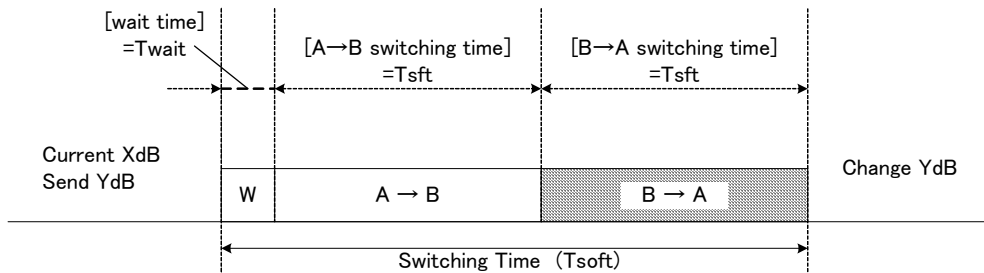

Figure 11. Micro step volume switching time

If the base clock is set to x1/2, the switching time will be doubled.

**Micro step volume circuit**

- 1. Micro step volume technology.
  - 1-1. Micro step volume effects.

Micro step volume is ROHM original switching pop noise prevention technology. The audible signal is discontinuous during the gain switching instantly which cause the noise to occur. This micro step volume will prevent this discontinuous signal by completing the signal waveform and will significantly reduce the noise.

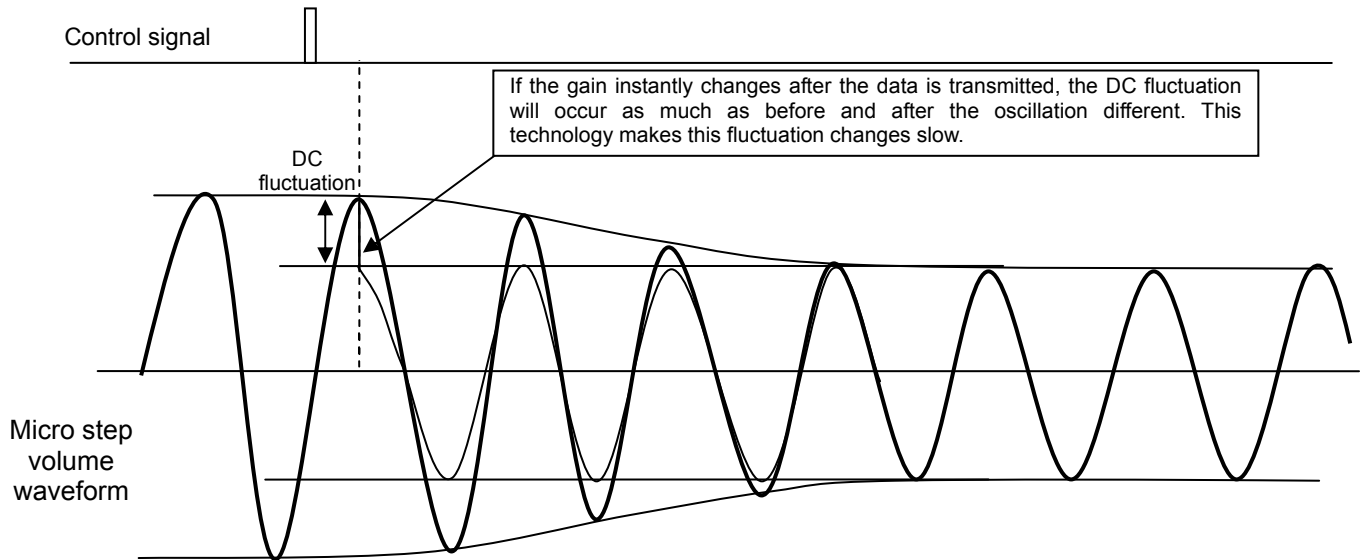

Figure 12. Micro step volume waveform

This micro step volume will start the switching when received the signal sent from the micon.  
 At any constant time, the switching waveform is shown as above figure. This IC will optimally operates by internally processes the data sent from the micon to prevent the switching shock.  
 However, sometimes the switching waveform is not like the intended form depends on the transmission timing. Therefore, below is the example of the relationship between the transmission timing and actual switching time. Please consider this relationship for the setting.

1-2. Micro step volume application target block

- Micro step volume application target blocks are 7.1ch volume and SUB volume.

2. About data transmission of Micro step volume circuit

2-1. Switching time of Micro step volume

This switching time includes [Wait time], [A→B switching time] and [B→A switching time]. Every switching time needs around 25msec. ( $T_{soft} = T_{wait} + 2 * T_{sft}$ ,  $T_{wait}=2.3msec$ ,  $T_{sft}=11.2msec$ )

Please take note that  $T_{wait}$  is wait time for starting switching and the setting is 2.3msec. ( $T_{wait}$  considers the internal IC tolerance, therefore this time need to be set within 1.3msec (Min.) to 4.6msec (Max.).

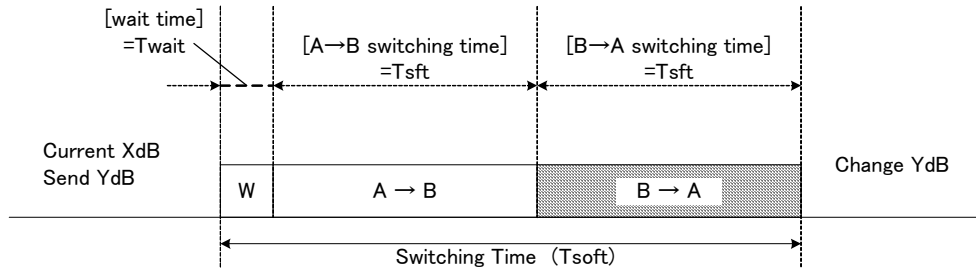

Figure 13. [A→B switching time] and [B→A switching time]

In addition, base clock can change the frequency using the internal oscillation device. For example, when base clock x1/2 is selected, [Wait time], [A→B switching time] and [B→A switching time] are doubled.

2-2. Same block data transmission timing and switching operation.

■ Transmission example 1

The time chart from data transmission to switching start time is shown as below. At first, below figure shows transmitted data with the same block which is separated with enough interval. This enough interval refers to the tolerance margin time of  $T_{soft}$  multiplied by 1.4.

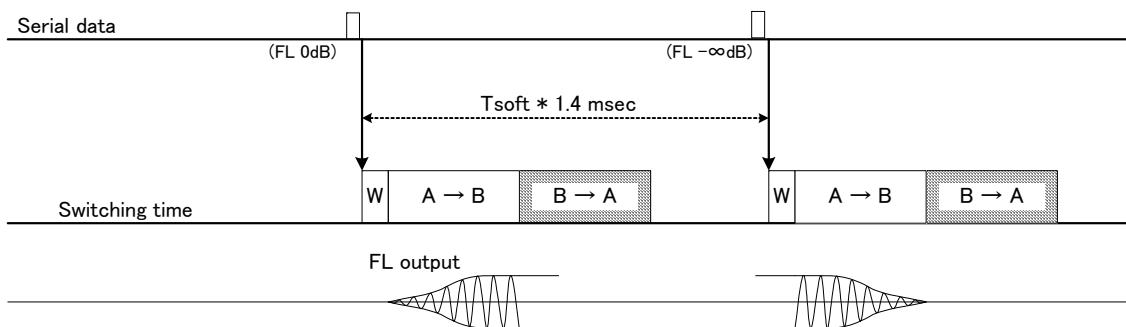

■ Transmission example 2

Next, below figure shows the example of when the transmission interval is not enough (smaller than above interval). When the data transmitted during the first operation of the switching, the second data transmission will continue after complete the first operation. In this case, there is no wait time ( $T_{wait}$ ) before the second transmission.

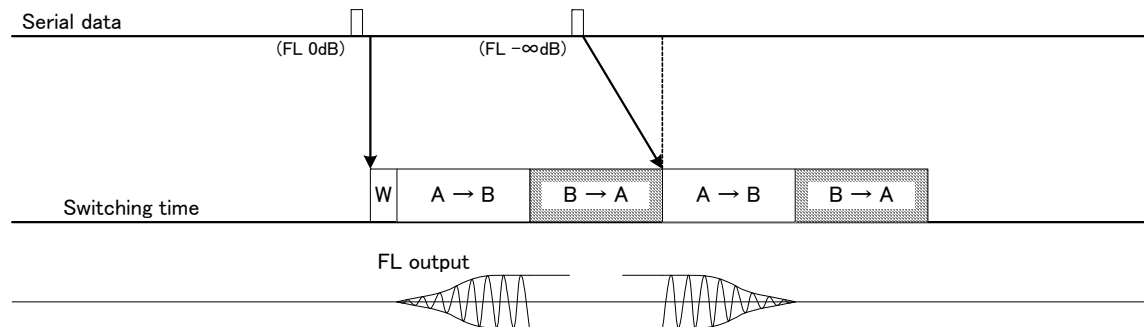



■ Transmission example 3

Next is the example for switching operation with smaller data transmission interval.

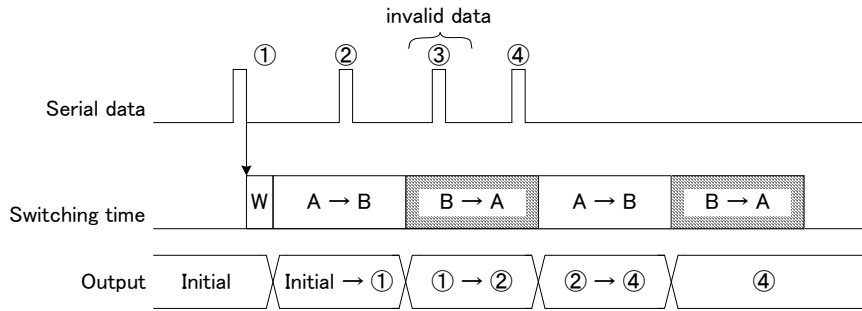

Data ② is the data during the A→B operation, so this data is valid, and then during B→A operation, data ① promptly switches to data ②.  
 Data ③ and data ④ are data during B→A operation, therefore these data are valid for the next switching, but data ③ got overwritten by data ④ so data ③ will become invalid. Only data ④ is valid.  
 There is no regulation on the transmission timing.

For data transmission to multi-channels, there is a caution. The combination of Lch and Rch for same block will make the switching is possible to change at same timing. When the setting is data ① for FL (Lch) and data ② for FR (Rch), same switching timing is possible if the data transmission is set as below figure.

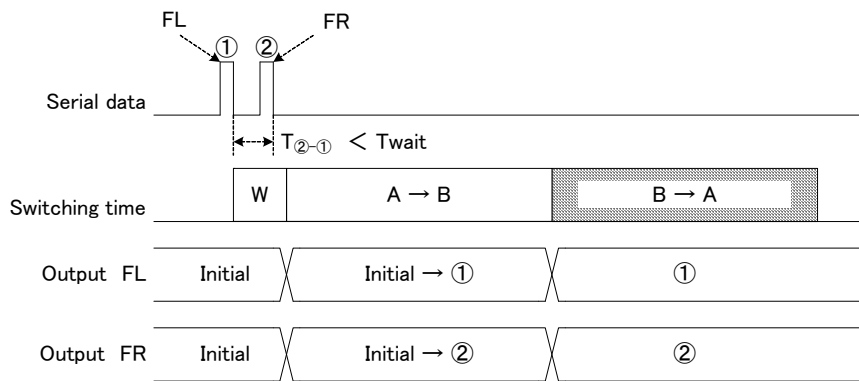

Figure 14. The operation during multi-channels (Lch, Rch) data transmission (smaller than Twait interval).

Next, when data ② is not transmitted during the Twait, the switching operation is as following figure.

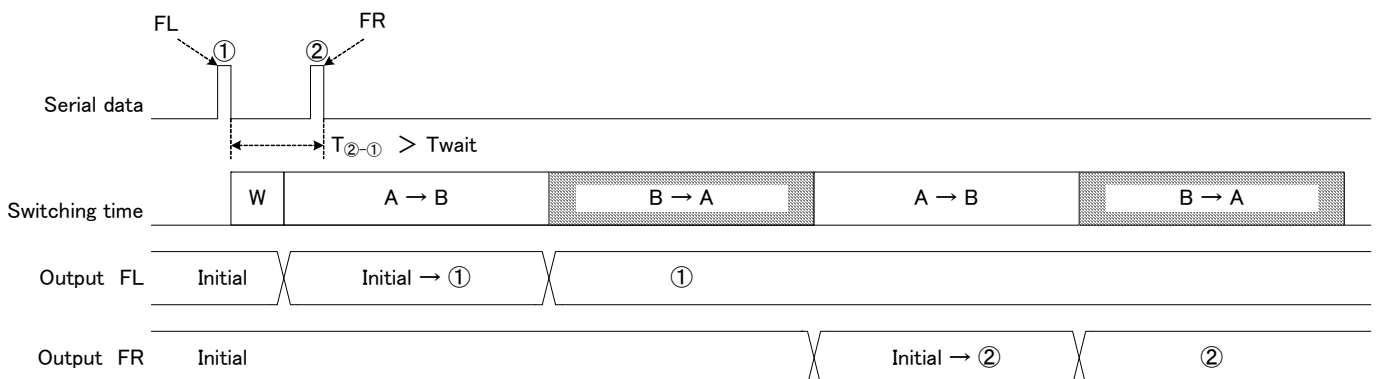

Figure 15. The operation during multi-channels (Lch, Rch) data transmission (larger than Twait interval).

2-3. Multi-blocks data transmission timing and switching operation.

In case of the data is transmitted to the multi-blocks, the processing is performed to each sequence which is defined by the IC internally.  
 This sequence determines the Micro step volume starting order operation.

■Transmission example 1

In case of multi-channels operates as transmission order (during 3 channels transmission).

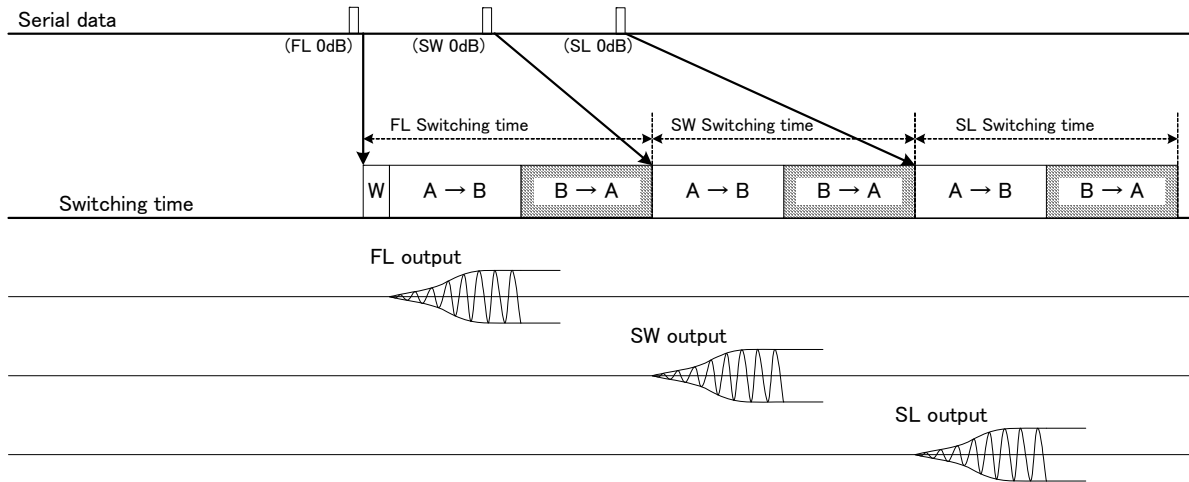

There is no constraint for the data transmission timing, however the timing of switching start becomes to switching after the current timing is ended.

Please take note that the timing of switching start is not depending on data setting order but only based on the regulated order by Figure16. (Transmission example 2)

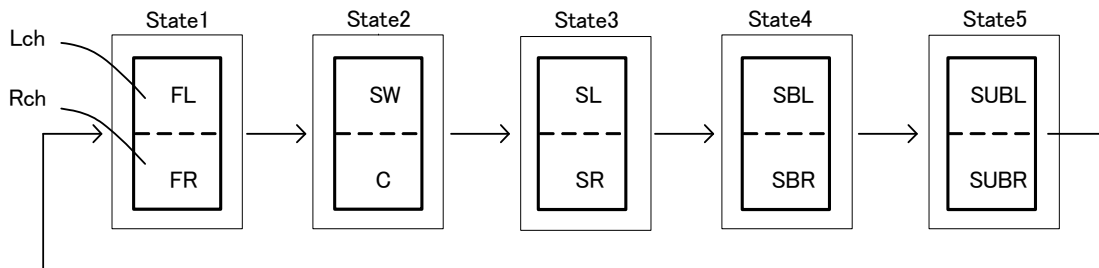
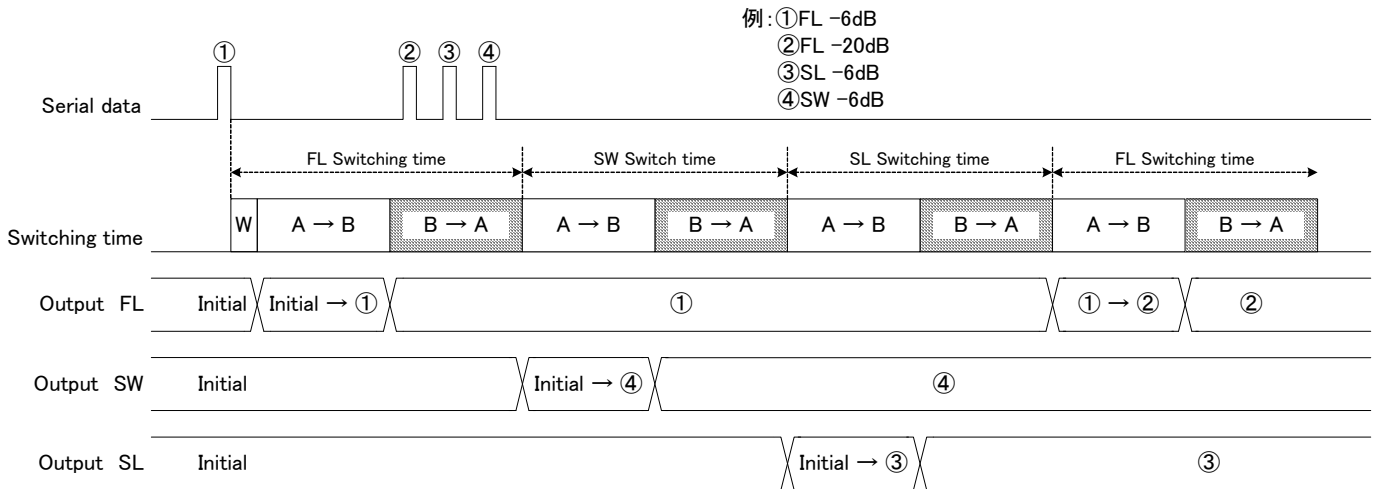

Figure 16. Volume switching stage

※ Blocks in the same stage is possible to start the switching at the same timing.

■Transmission example 2

In case of the transmission order is different with actual switching order.



During FL switching, in case of FL/SW/SL continuously received, SW and SL switching are the priority. If you want the switching starts as the data transmission order, please transmit the next data after current switching is ended.

■Transmission example 3

For same data transmission, the IC will internally judge that there is no difference with the current data setting and therefore gain switching operation will not start.

Continuing the same data transmission and transmit the other block data.

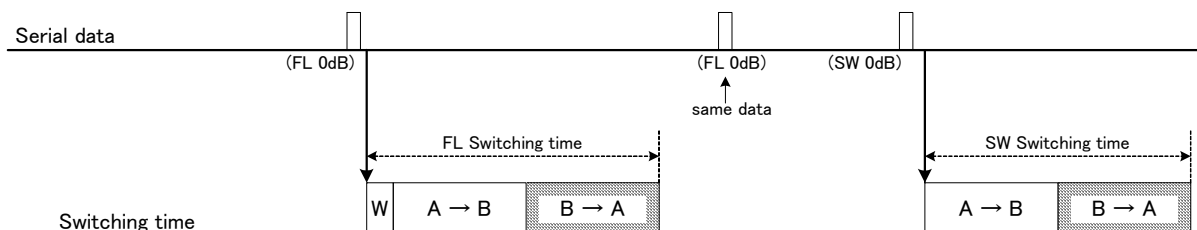

2-4. How to reduce pop noise

Pop noise level is different base on the Micro step internal state A and B output DC offset difference. To reduce the pop noise level, set for longer switching time might solve this problem. Change the setting for [A→B switching time] and [B→A switching time], and confirm pop the noise level. At this time, if [A→B switching time] and [A→B switching time] setting is different, the pop noise reduction effect will decrease. Therefore, it is recommended to set these switching with same time.

Application Circuit Diagram

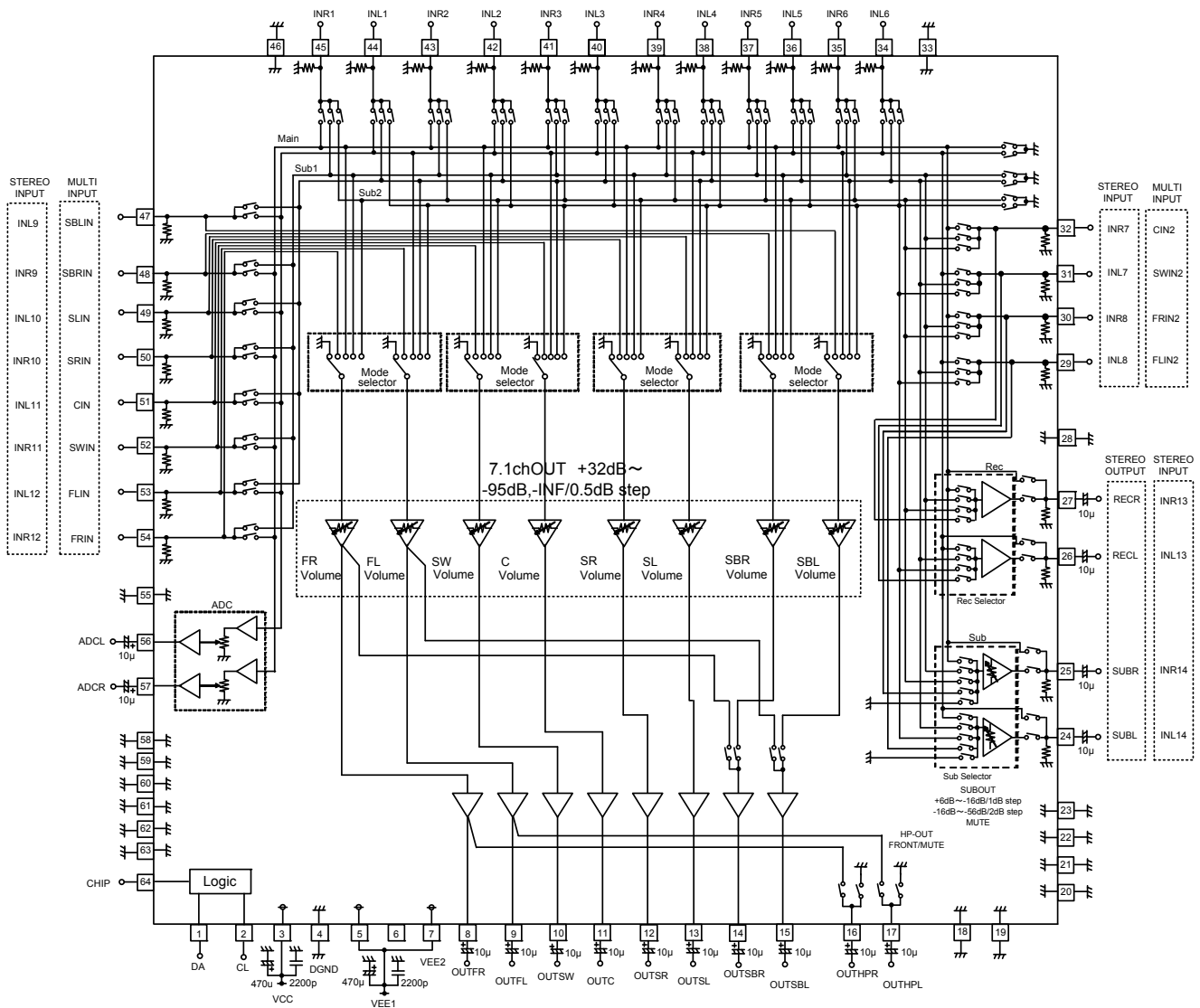

Figure 17. Application Circuit Diagram

Notes on wiring

- ① GND has to be wired from reference point and it should be thick.
- ② Wiring pattern of CL and DA shall be away from the analog unit and cross-talk is not acceptable.
- ③ If possible, lines of CL and DA are not parallel. If they are adjacent to each other, the lines should be shielded.
- ④ Please concentrate on wiring pattern of the input terminal for input selector to the crosstalk. It is recommended that it is shielded during wiring period.
- ⑤ Please connect the decoupling capacitor of the power supply in the shortest distance as much as possible to VCC, GND and VEE.

**Power Dissipation**

Thermal design for the IC

Temperature has great influence to the IC characteristics, and exceeding the absolute maximum ratings may degrade and damage the IC. A proper consideration must be given from two points, immediate damage and long-term reliability of operation.

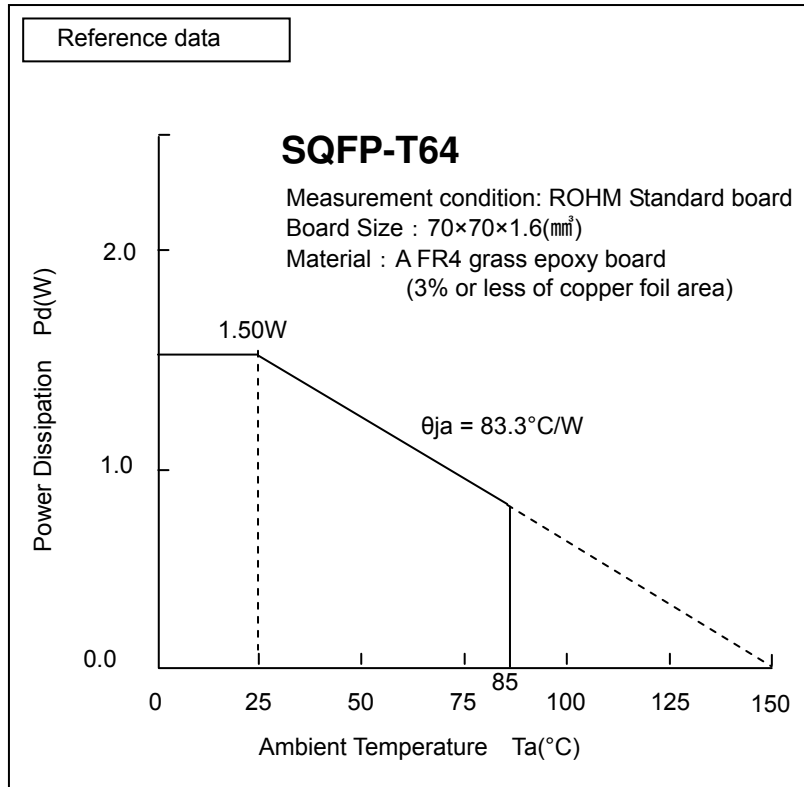
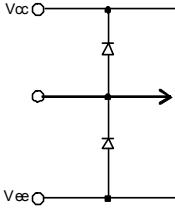
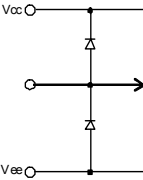
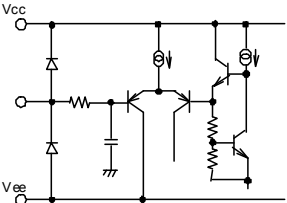
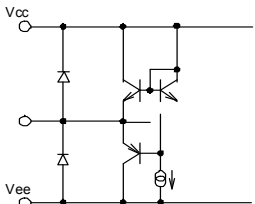
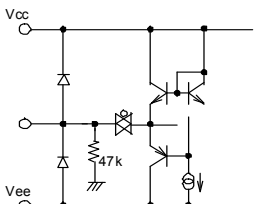

Figure 18. Temperature Derating Curve

Note) Values mentioned above are based on actual measurement, and not guaranteed.

Power dissipation value varies depending to the board on which the IC is mounted.

I/O equivalence circuit(s)

Terminal Number	Terminal Name	Terminal Voltage (V)	Equivalent Circuit	Terminal Description
18~23 28 33 46 55 58~63	GND	0		Analog ground terminals.
3 5 7	VCC VEE1 VEE2	+7 -7		Positive power supply terminal Negative power supply terminal
4	DGND	0		Digital ground terminal.
1 2 64	DA CL CHIP	-		Input terminals for a clock and data.
8 9 10 11 12 13 14 15 56 57	OUTFRL OUTFL OUTSW OUTC OUTSR OUTSL OUTSBR OUTSBL ADCL ADCR	0		Output terminals for analog sound signal.
24 25 26 27	SUBL SUBR RECL RECR	0		Output terminals for analog sound signal. (SUB/REC)

Terminal Number	Terminal Name	Terminal Voltage (V)	Equivalent Circuit	Terminal Description
30 29 32 31 35 34 37 36 39 38 41 40 43 42 45 44	INR8 INL8 INR7 INL7 INR6 INL6 INR5 INL5 INR4 INL4 INR3 INL3 INR2 INL2 INR1 INL1	0		Input terminals for stereo sound signal. Input impedance is 47kΩ(Typ.).
48 47 50 49 51 52 54 53	SBRIN SBLIN SRIN SLIN CIN SWIN FRIN FLIN	0		Input terminals for an analog multi sound signal. Input impedance is 47kΩ(Typ.).
16 17	OUTHPR OUTHPL	0		Output terminal for FRONT pre-output. The impedance of output switch is 0.8kΩ(typ.).

## Operational Notes

### 1. Reverse Connection of Power Supply

Connecting the power supply in reverse polarity can damage the IC. Take precautions against reverse polarity when connecting the power supply, such as mounting an external diode between the power supply and the IC's power supply terminals.

### 2. Power Supply Lines

Design the PCB layout pattern to provide low impedance supply lines. Separate the ground and supply lines of the digital and analog blocks to prevent noise in the ground and supply lines of the digital block from affecting the analog block. Furthermore, connect a capacitor to ground at all power supply pins. Consider the effect of temperature and aging on the capacitance value when using electrolytic capacitors.

### 3. Vee Voltage

Ensure that no pins are at a voltage below that of the VEE pin at any time, even during transient condition.

### 4. Ground Wiring Pattern

GND pins which are digital ground(4pin) and analog ground(18-23,28,33,46,55,58-63pin) are not connected inside LSI. These ground pins traces should be routed separately but connected to a single ground at the reference point of the application board. Also ensure that the ground traces of external components do not cause variations on the ground voltage. The ground lines must be as short and thick as possible to reduce line impedance.

### 5. Thermal Consideration

Should by any chance the power dissipation rating be exceeded the rise in temperature of the chip may result in deterioration of the properties of the chip. The absolute maximum rating of the Pd stated in this specification is when the IC is mounted on a 70mm x 70mm x 1.6mm glass epoxy board. In case of exceeding this absolute maximum rating, increase the board size and copper area to prevent exceeding the Pd rating.

### 6. Recommended Operating Conditions

These conditions represent a range within which the expected characteristics of the IC can be approximately obtained. The electrical characteristics are guaranteed under the conditions of each parameter.

### 7. Rush Current

When power is first supplied to the IC, it is possible that the internal logic may be unstable and inrush current may flow instantaneously due to the internal powering sequence and delays, especially if the IC has more than one power supply. Therefore, give special consideration to power coupling capacitance, power wiring, width of ground wiring, and routing of connections.

### 8. Operation Under Strong Electromagnetic Field

Operating the IC in the presence of a strong electromagnetic field may cause the IC to malfunction.

### 9. Testing on Application Boards

When testing the IC on an application board, connecting a capacitor directly to IC pin may subject the IC to stress. Always discharge capacitors completely after each process or step. The IC's power supply should always be turned off completely before connecting or removing it from the test setup during the inspection process. To prevent damage from static discharge, ground the IC during assembly and use similar precautions during transport and storage.

### 10. Inter-pin Short and Mounting Errors

Ensure that the direction and position are correct when mounting the IC on the PCB. Incorrect mounting may result in damaging the IC. Avoid nearby pins being shorted to each other especially to ground, power supply and output pin. Inter-pin shorts could be due to many reasons such as metal particles, water droplets (in very humid environment) and unintentional solder bridge deposited in between pins during assembly to name a few.

### 11. Unused Input Terminals

Because the input impedance of the terminal becomes 47kΩ when the signal input terminal makes a terminal open, the plunge noise from outside sometimes becomes a problem. Please connect the no using input pin to GND. And please open the no using output pin.



Operational Notes – continued 1

12. Regarding the Input Pin of the IC

This monolithic IC contains P+ isolation and P substrate layers between adjacent elements in order to keep them isolated. P-N junctions are formed at the intersection of the P layers with the N layers of other elements, creating a parasitic diode or transistor. For example (refer to figure below):

When Vee > Pin A and Vee > Pin B, the P-N junction operates as a parasitic diode.  
 When Vee > Pin B, the P-N junction operates as a parasitic transistor.

Parasitic diodes inevitably occur in the structure of the IC. The operation of parasitic diodes can result in mutual interference among circuits, operational faults, or physical damage. Therefore, conditions that cause these diodes to operate, such as applying a voltage lower than the Vee voltage to an input pin (and thus to the P substrate) should be avoided.

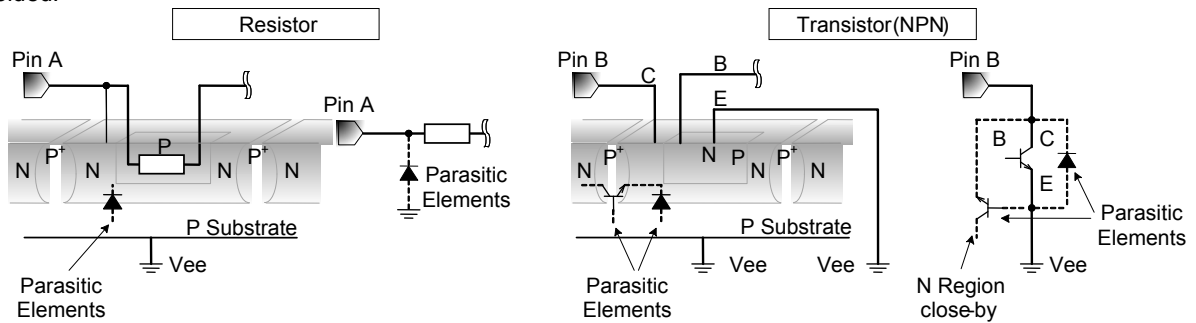

Figure 19. Example of monolithic IC structure

13. Ceramic Capacitor

When using a ceramic capacitor, determine the dielectric constant considering the change of capacitance with temperature and the decrease in nominal capacitance due to DC bias and others.

14. About power ON/OFF

1. At power ON/OFF, a pop sound will be generated and, therefore, use MUTE on the set.
2. When turning on power supplies, VEE and VCC should be powered on simultaneously or VEE first; then followed by VCC. ( $t_{delay}$  should be  $VEE < VCC$  on power ON,  $VCC < VEE$  on power OFF) If the VCC side is started up first, an excessive current may pass VCC through Vee.
3. This IC include power ON reset circuit. To be effective this function,  $t_{rise}$  should be more than 20μsec.

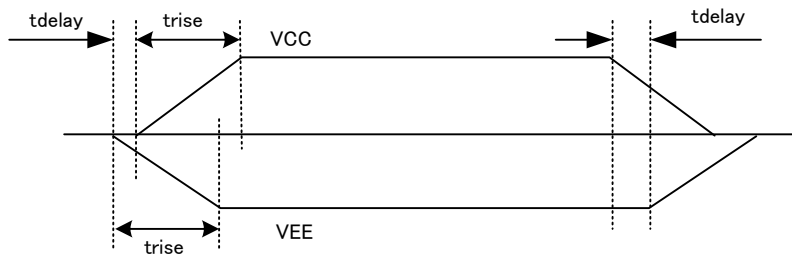

Figure 20. Timing sequence of power on/off operation

15. About function switching

When switching Input Selector, Mode selector or Input Gain, use MUTE on Volume.

16. Volume gain switching

In case of the boost of the volume when changing to the high gain which exceeds +20dB especially, the switching pop noise sometimes becomes big. In this case, we recommend changing every 1 dB step without changing a gain at once. Also, the pop noise sometimes can reduce by making micro-step volume switching time long, too.

Operational Notes – continued 2

17. Output load characteristic

The usages of load for output are below (reference). Please use the load more than 10 kΩ(TYP).

Output terminal

Terminal No.	Terminal Name	Terminal No.	Terminal Name	Terminal No.	Terminal Name	Terminal No.	Terminal Name
8	OUTFR	12	OUTSR	25	SUBR	56	ADCL
9	OUTFL	13	OUTSL	24	SUBL	57	ADCR
10	OUTSW	14	OUTSBR	27	RECR	-	-
11	OUTC	15	OUTSBL	26	RECL	-	-

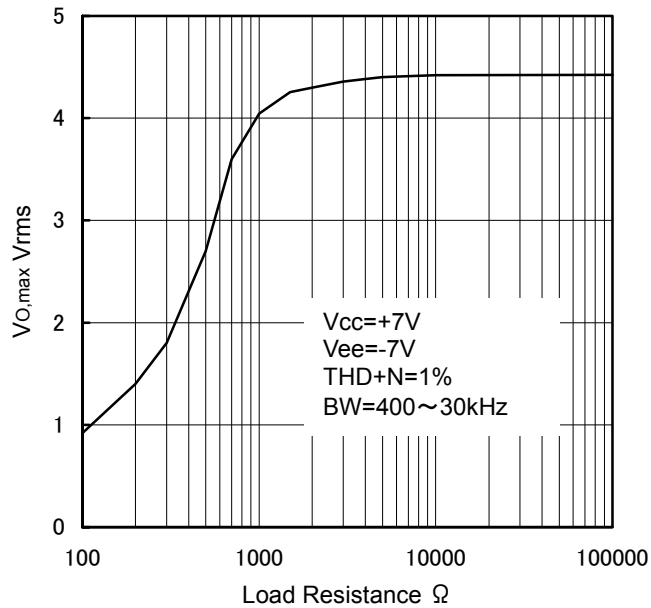
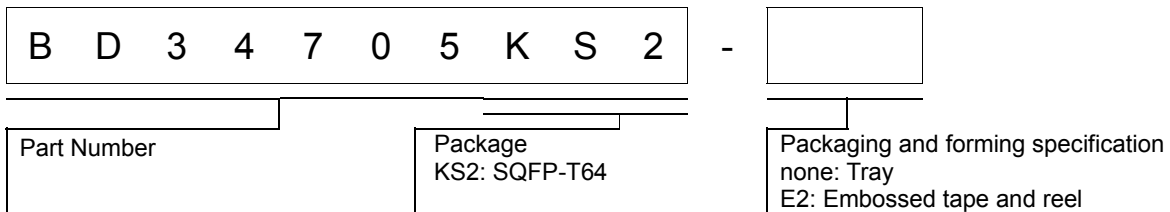
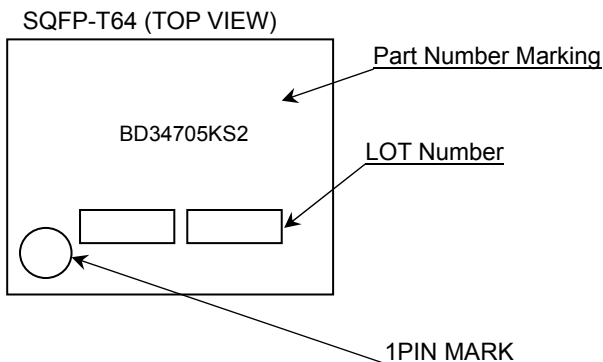

Figure 21. Output load characteristic at Vcc=+7V, Vee=-7V(Reference)

Ordering Information



Marking Diagram(TOP VIEW)



Physical Dimension, Tape and Reel Information

Package Name	SQFP-T64
--------------	----------

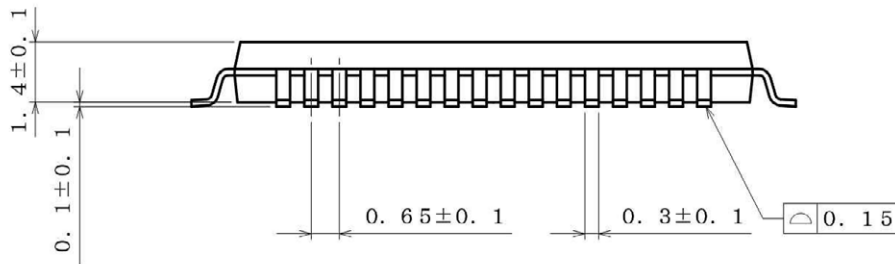
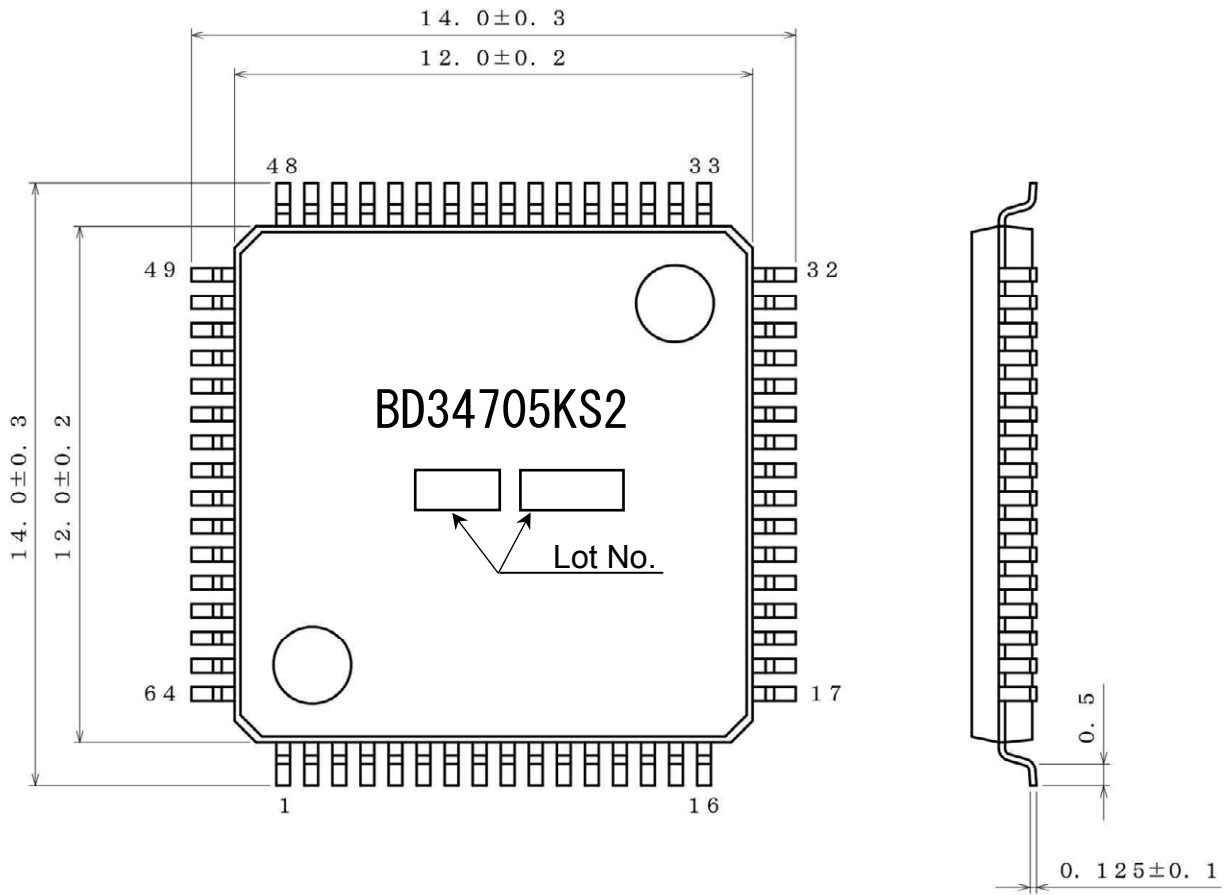

(UNIT : mm)  
 PKG : SQFP-T64  
 Drawing No. B0549

<Tape and Reel information>

Container	Tray (with dry pack)
Quantity	1000pcs
Direction of feed	Direction of product is fixed in a tray

\*Order quantity needs to be multiple of the minimum quantity.

## 改訂履歴

Date	Revision	変更内容
31.Mar.2015	001	New Release

# Notice

## Precaution on using ROHM Products

- Our Products are designed and manufactured for application in ordinary electronic equipments (such as AV equipment, OA equipment, telecommunication equipment, home electronic appliances, amusement equipment, etc.). If you intend to use our Products in devices requiring extremely high reliability (such as medical equipment <sup>(Note 1)</sup>, transport equipment, traffic equipment, aircraft/spacecraft, nuclear power controllers, fuel controllers, car equipment including car accessories, safety devices, etc.) and whose malfunction or failure may cause loss of human life, bodily injury or serious damage to property ("Specific Applications"), please consult with the ROHM sales representative in advance. Unless otherwise agreed in writing by ROHM in advance, ROHM shall not be in any way responsible or liable for any damages, expenses or losses incurred by you or third parties arising from the use of any ROHM's Products for Specific Applications.

(Note1) Medical Equipment Classification of the Specific Applications

JAPAN	USA	EU	CHINA
CLASS III	CLASS III	CLASS II b	CLASS III
CLASS IV		CLASS III	

- ROHM designs and manufactures its Products subject to strict quality control system. However, semiconductor products can fail or malfunction at a certain rate. Please be sure to implement, at your own responsibilities, adequate safety measures including but not limited to fail-safe design against the physical injury, damage to any property, which a failure or malfunction of our Products may cause. The following are examples of safety measures:
  - Installation of protection circuits or other protective devices to improve system safety
  - Installation of redundant circuits to reduce the impact of single or multiple circuit failure
- Our Products are designed and manufactured for use under standard conditions and not under any special or extraordinary environments or conditions, as exemplified below. Accordingly, ROHM shall not be in any way responsible or liable for any damages, expenses or losses arising from the use of any ROHM's Products under any special or extraordinary environments or conditions. If you intend to use our Products under any special or extraordinary environments or conditions (as exemplified below), your independent verification and confirmation of product performance, reliability, etc. prior to use, must be necessary:
  - Use of our Products in any types of liquid, including water, oils, chemicals, and organic solvents
  - Use of our Products outdoors or in places where the Products are exposed to direct sunlight or dust
  - Use of our Products in places where the Products are exposed to sea wind or corrosive gases, including Cl<sub>2</sub>, H<sub>2</sub>S, NH<sub>3</sub>, SO<sub>2</sub>, and NO<sub>2</sub>
  - Use of our Products in places where the Products are exposed to static electricity or electromagnetic waves
  - Use of our Products in proximity to heat-producing components, plastic cords, or other flammable items
  - Sealing or coating our Products with resin or other coating materials
  - Use of our Products without cleaning residue of flux (even if you use no-clean type fluxes, cleaning residue of flux is recommended); or Washing our Products by using water or water-soluble cleaning agents for cleaning residue after soldering
  - Use of the Products in places subject to dew condensation
- The Products are not subject to radiation-proof design.
- Please verify and confirm characteristics of the final or mounted products in using the Products.
- In particular, if a transient load (a large amount of load applied in a short period of time, such as pulse. is applied, confirmation of performance characteristics after on-board mounting is strongly recommended. Avoid applying power exceeding normal rated power; exceeding the power rating under steady-state loading condition may negatively affect product performance and reliability.
- De-rate Power Dissipation (Pd) depending on Ambient temperature (Ta). When used in sealed area, confirm the actual ambient temperature.
- Confirm that operation temperature is within the specified range described in the product specification.
- ROHM shall not be in any way responsible or liable for failure induced under deviant condition from what is defined in this document.

## Precaution for Mounting / Circuit board design

- When a highly active halogenous (chlorine, bromine, etc.) flux is used, the residue of flux may negatively affect product performance and reliability.
- In principle, the reflow soldering method must be used on a surface-mount products, the flow soldering method must be used on a through hole mount products. If the flow soldering method is preferred on a surface-mount products, please consult with the ROHM representative in advance.

For details, please refer to ROHM Mounting specification

### Precautions Regarding Application Examples and External Circuits

1. If change is made to the constant of an external circuit, please allow a sufficient margin considering variations of the characteristics of the Products and external components, including transient characteristics, as well as static characteristics.
2. You agree that application notes, reference designs, and associated data and information contained in this document are presented only as guidance for Products use. Therefore, in case you use such information, you are solely responsible for it and you must exercise your own independent verification and judgment in the use of such information contained in this document. ROHM shall not be in any way responsible or liable for any damages, expenses or losses incurred by you or third parties arising from the use of such information.

### Precaution for Electrostatic

This Product is electrostatic sensitive product, which may be damaged due to electrostatic discharge. Please take proper caution in your manufacturing process and storage so that voltage exceeding the Products maximum rating will not be applied to Products. Please take special care under dry condition (e.g. Grounding of human body / equipment / solder iron, isolation from charged objects, setting of Ionizer, friction prevention and temperature / humidity control).

### Precaution for Storage / Transportation

1. Product performance and soldered connections may deteriorate if the Products are stored in the places where:
  - [a] the Products are exposed to sea winds or corrosive gases, including Cl<sub>2</sub>, H<sub>2</sub>S, NH<sub>3</sub>, SO<sub>2</sub>, and NO<sub>2</sub>
  - [b] the temperature or humidity exceeds those recommended by ROHM
  - [c] the Products are exposed to direct sunshine or condensation
  - [d] the Products are exposed to high Electrostatic
2. Even under ROHM recommended storage condition, solderability of products out of recommended storage time period may be degraded. It is strongly recommended to confirm solderability before using Products of which storage time is exceeding the recommended storage time period.
3. Store / transport cartons in the correct direction, which is indicated on a carton with a symbol. Otherwise bent leads may occur due to excessive stress applied when dropping of a carton.
4. Use Products within the specified time after opening a humidity barrier bag. Baking is required before using Products of which storage time is exceeding the recommended storage time period.

### Precaution for Product Label

QR code printed on ROHM Products label is for ROHM's internal use only.

### Precaution for Disposition

When disposing Products please dispose them properly using an authorized industry waste company.

### Precaution for Foreign Exchange and Foreign Trade act

Since concerned goods might be fallen under listed items of export control prescribed by Foreign exchange and Foreign trade act, please consult with ROHM in case of export.

### Precaution Regarding Intellectual Property Rights

1. All information and data including but not limited to application example contained in this document is for reference only. ROHM does not warrant that foregoing information or data will not infringe any intellectual property rights or any other rights of any third party regarding such information or data.
2. ROHM shall not have any obligations where the claims, actions or demands arising from the combination of the Products with other articles such as components, circuits, systems or external equipment (including software).
3. No license, expressly or implied, is granted hereby under any intellectual property rights or other rights of ROHM or any third parties with respect to the Products or the information contained in this document. Provided, however, that ROHM will not assert its intellectual property rights or other rights against you or your customers to the extent necessary to manufacture or sell products containing the Products, subject to the terms and conditions herein.

### Other Precaution

1. This document may not be reprinted or reproduced, in whole or in part, without prior written consent of ROHM.
2. The Products may not be disassembled, converted, modified, reproduced or otherwise changed without prior written consent of ROHM.
3. In no event shall you use in any way whatsoever the Products and the related technical information contained in the Products or this document for any military purposes, including but not limited to, the development of mass-destruction weapons.
4. The proper names of companies or products described in this document are trademarks or registered trademarks of ROHM, its affiliated companies or third parties.

**General Precaution**

1. Before you use our Products, you are requested to carefully read this document and fully understand its contents. ROHM shall not be in any way responsible or liable for failure, malfunction or accident arising from the use of any ROHM's Products against warning, caution or note contained in this document.
2. All information contained in this document is current as of the issuing date and subject to change without any prior notice. Before purchasing or using ROHM's Products, please confirm the latest information with a ROHM sales representative.
3. The information contained in this document is provided on an "as is" basis and ROHM does not warrant that all information contained in this document is accurate and/or error-free. ROHM shall not be in any way responsible or liable for any damages, expenses or losses incurred by you or third parties resulting from inaccuracy or errors of or concerning such information.