

Click to  
**ORDER**  
samples

**AMEOF10-277NZ**

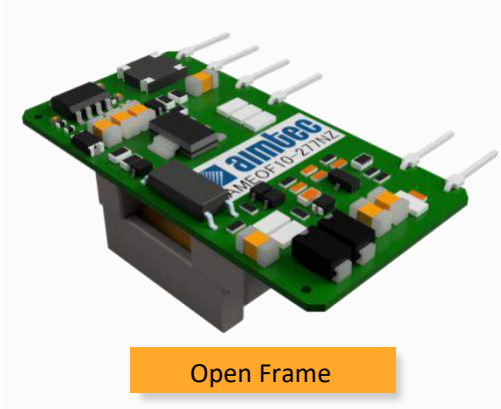

Open Frame

AMEOF10-277NZ series is one of Aimtec highly efficient green 10W AC-DC converters. They feature a wide input voltage range of 85-305VAC, high efficiency up to 82%, low power consumption and CLASS II reinforced insulation. The large variety of EMC external circuits meet the needs of multiple industries. This new series offers great operating temperatures, from -40°C to 85°C and an isolation of 3000VAC for improved reliability and system safety. Furthermore, a high MTBF of 300,000h, output short circuit protection (OSCP), output over-current protection (OCP) and an output over-voltage protection (OVP) come standard with the series. All models are suitable for industrial controls, instrumentation and smart home applications with size constraints.

**Features**

- Universal Input: 85 - 305VAC/100 - 430VDC
- Operating Temp: -40 °C to +85 °C
- High isolation voltage: 3000VAC
- Low ripple & noise, 150mV(p-p), max.
- Output short circuit, over-current, over voltage protection
- Open frame package

**Summary**

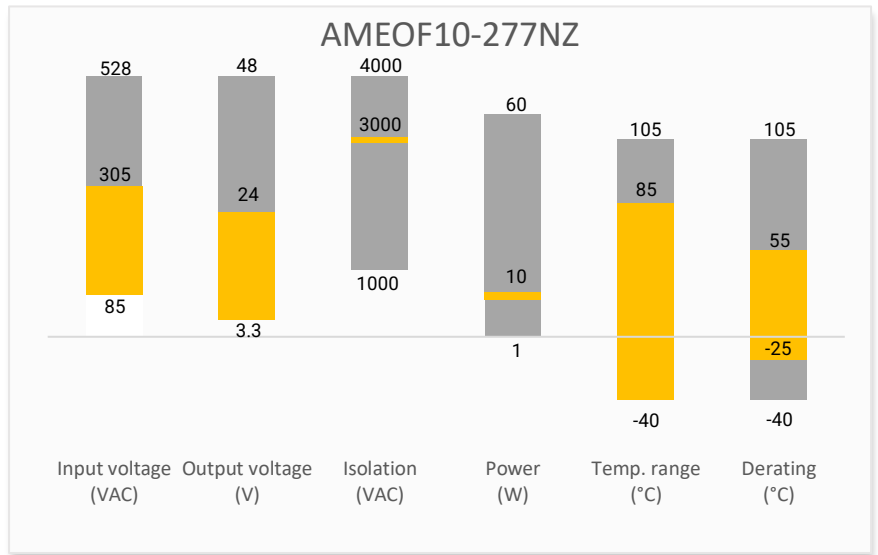

**Training**



Product Training Video  
(click to open)



Press Release

Coming Soon!

Application Notes

**Applications**



## Models & Specifications

### Single Output

Model	Input Voltage (VAC/Hz)	Input Voltage (VDC)	Max Output wattage (W)	Output Voltage (V)	Output Current max (A)	Maximum capacitive load ( $\mu$ F)	Efficiency @ 230VAC (%)
AMEOF10-03S277NZ	85~305/47~63	100~430	6.6	3.3	2	1500	70
AMEOF10-05S277NZ	85~305/47~63	100~430	10	5	2	1500	76
AMEOF10-09S277NZ	85~305/47~63	100~430	10	9	1.1	1000	78
AMEOF10-12S277NZ	85~305/47~63	100~430	10	12	0.83	680	80
AMEOF10-15S277NZ	85~305/47~63	100~430	10	15	0.67	470	81
AMEOF10-24S277NZ	85~305/47~63	100~430	10	24	0.42	330	82
AMEOF10-03SL277NZ	85~305/47~63	100~430	6.6	3.3	2	1500	70
AMEOF10-05SL277NZ	85~305/47~63	100~430	10	5	2	1500	76
AMEOF10-09SL277NZ	85~305/47~63	100~430	10	9	1.1	1000	78
AMEOF10-12SL277NZ	85~305/47~63	100~430	10	12	0.83	680	80
AMEOF10-15SL277NZ	85~305/47~63	100~430	10	15	0.67	470	81
AMEOF10-24SL277NZ	85~305/47~63	100~430	10	24	0.42	330	82

### Input Specifications

Parameters	Conditions	Typical	Maximum	Units
Input Current	115VAC		300	mA
	230VAC		150	
Inrush current	115VAC	15		A
	230VAC	30		
External fuse	Slow blow type	1		A

### Output Specifications

Parameters	Conditions	Typical	Maximum	Units	
Voltage accuracy	Full load	3.3V output	$\pm 1.5$	$\pm 3$	%
		other	$\pm 1$	$\pm 2$	
Line regulation	Full load	$\pm 0.5$	$\pm 1$	%	
Load regulation	0-100% load	$\pm 1$	$\pm 1.5$	%	
Ripple & Noise	20MHz bandwidth	80	150	mV p-p	

### Isolation Specifications

Parameters	Conditions	Typical	Rated	Units
Tested I/O voltage	60 sec, 5mA max		3000	VAC

### General Specifications

Parameters	Conditions	Typical	Maximum	Units
Safety class	Class II			
Over Current protection	Auto recovery	$\geq 110$		% of Iout
Short circuit protection	Hiccup, Continuous			
Over voltage protection	3.3V / 5V output model	$\leq 9$ VDC (output voltage clamp or hiccup)		

Power derating	9V output model	≤ 15VDC (output voltage clamp or hiccup)	
	12V / 15V output model	≤ 25VDC (output voltage clamp or hiccup)	
	24V output model	≤ 35VDC (output voltage clamp or hiccup)	
	-40 °C to -25 °C	2.67	% / °C
	+55 °C to +85 °C	2.5	% / °C
Operating temperature	-40 to +85	°C	
	Storage temperature	-40 to +105 °C	
Temperature coefficient	±0.02	% / °C	
Cooling	Free air convection		
Storage Humidity		95	% RH
Weight		11	g
Dimensions (L x W x H)	1.75 x 0.94 x 0.59 inches (44.50 x 24.00 x 15.00mm)		
MTBF	> 300 000 hrs (MIL-HDBK -217F, t=+25°C)/Full Load		
NOTE: All specifications in this datasheet are measured at an ambient temperature of 25°C, humidity<75%, nominal input voltage and at rated output load unless otherwise specified.			

Safety Specifications		
Parameters		
Agency approvals	UL 62368-1	
Standards	Design to meet EN60335 / EN62368-1	
	EMC - Conducted and radiated emission	CISPR32 / EN55032, Class A, (With EMI Class A circuit) CISPR32 / EN55032, Class B, (With EMI Class B circuit)
	Electrostatic Discharge Immunity	IEC 61000-4-2 Contact ±6KV, Criteria B
	RF, Electromagnetic Field Immunity	IEC 61000-4-3 10V/m, Criteria A
	Electrical Fast Transient/Burst Immunity	IEC 61000-4-4 ±2KV, Criteria B, (With EMS Class III circuit) IEC 61000-4-4 ±4KV, Criteria B, (With EMS Class IV circuit)
	Surge Immunity	IEC 61000-4-5 L-L ±1KV, Criteria B, (With EMS Class III circuit) IEC 61000-4-5 L-L ±2KV, Criteria B, (With EMS Class IV circuit) IEC 61000-4-5 L-L ±4KV, Criteria B, (With EFT Class IV, Surge L-G ±4KV circuit)
	RF, Conducted Disturbance Immunity	IEC 61000-4-6 10Vr.m.s, Criteria A
	Voltage dips, Short Interruptions Immunity	IEC 61000-4-11 0%, 70%, Criteria B

## Derating

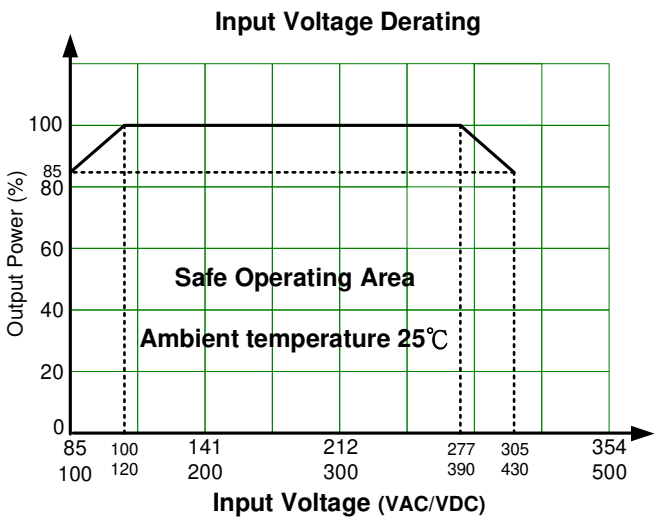
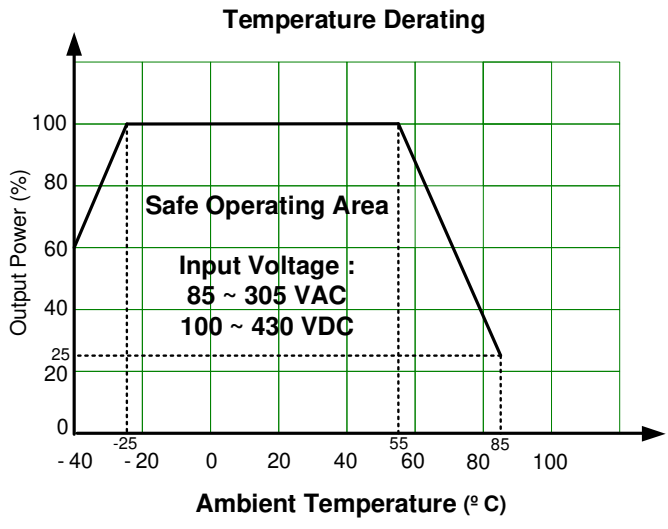

## Dimensions

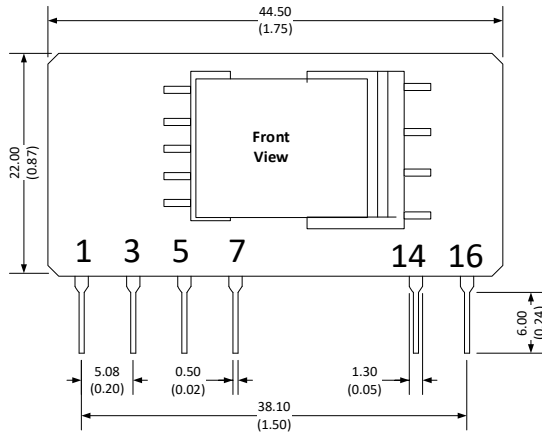

Note:  
Unit: mm [inch]  
Pin section tolerances:  $\pm 0.10$  [ $\pm 0.004$ ]  
General tolerances:  $\pm 0.50$  [ $\pm 0.020$ ]

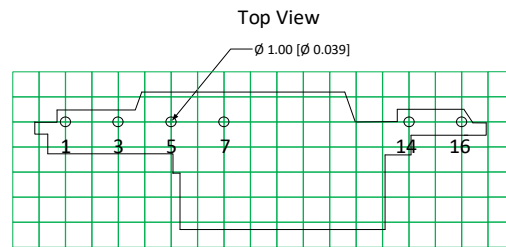
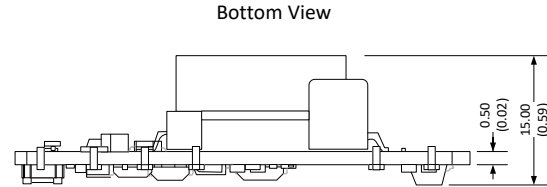

Note : Grid 2.54\*2.54 mm

## L Model Dimensions

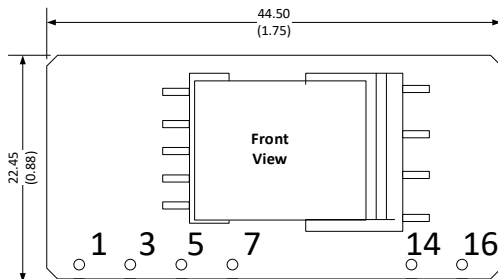

Note:  
Unit: mm [inch]  
Pin section tolerances:  $\pm 0.10$  [ $\pm 0.004$ ]  
General tolerances:  $\pm 0.50$  [ $\pm 0.020$ ]

Pin Output Specifications	
Pin	Function
1	AC Input (N)
3	AC Input (L)
5	+V_Cap
7	-V_Cap
14	-V Output
16	+V Output

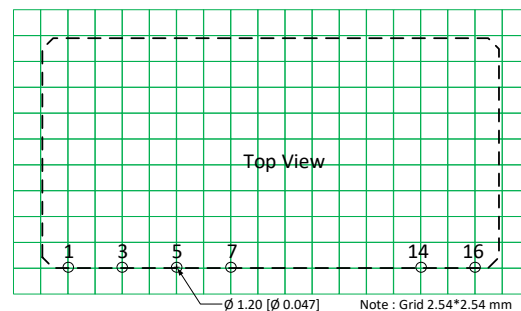
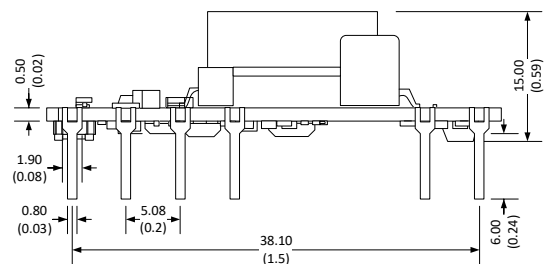

Note : Grid 2.54\*2.54 mm

Note:

1. Capacitor between pin5 and pin7 is necessary.
2. External circuit on the output side is necessary. Please refer to the recommended circuit.
3. It is needed to have distance  $\geq 6.4$ mm for safety between external components in primary circuit and secondary circuit.
4. The layout of the device is for reference only, please refer to the actual product.

## Recommended EMC external circuit

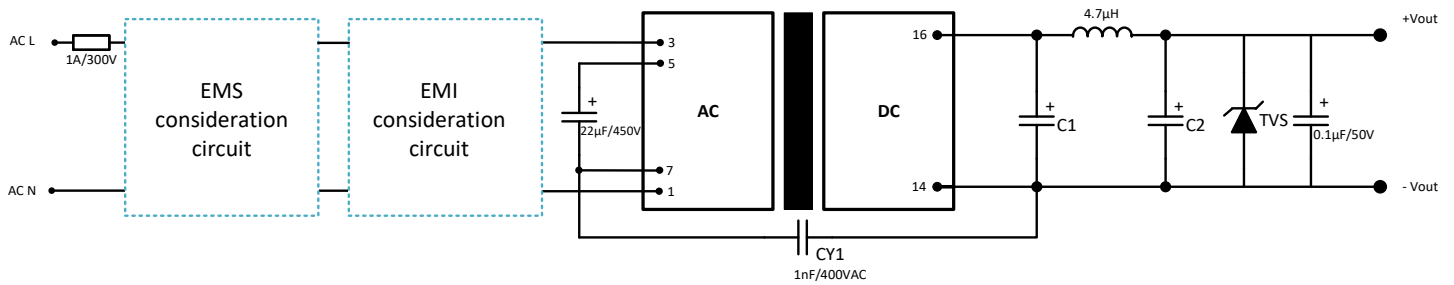

A suppressor diode (TVS) with 1.2 times of the output voltage rating is recommended.

### EMI & EMS Recommended Circuit

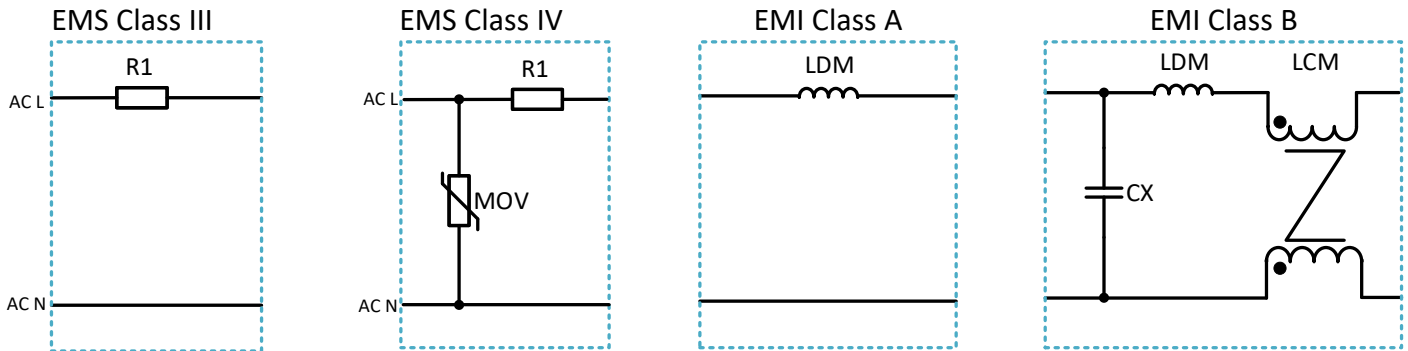

Component	EMS		EMI	
	Class III	Class IV	CLASS A	CLASS B
MOV	-	S14K350	-	-
R1	12Ω/3W	12Ω/3W	-	-
CX	-	-	-	0.1μF/310VAC
LCM	-	-	-	3.5mH
LDM	-	-	4.7mH	0.33mH
FUSE	1A/300V	2A/300V	1A/300V	1A/300V

Model name	C1	C2
3.3 VDC output	470μF/16V (Solid capacitor)	150μF/35V
5 VDC output	470μF/16V (Solid capacitor)	150μF/35V
9 VDC output	220μF/16V (Solid capacitor)	100μF/35V
12 VDC output	220μF/16V (Solid capacitor)	100μF/35V
15 VDC output	470μF/35V	47μF/35V
24 VDC output	220μF/35V	47μF/35V

## Recommended EMC circuit for EN60335

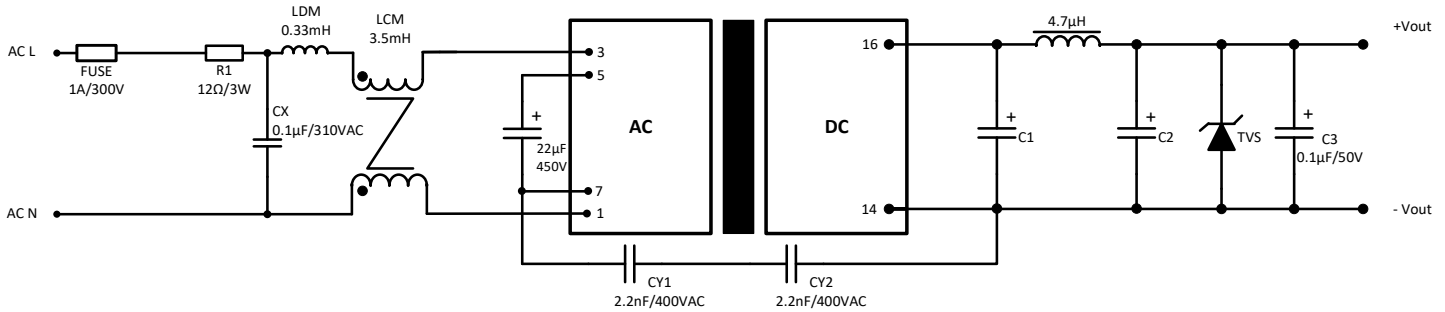

## Recommended EMC circuit for EMI Class B, EMS Class IV

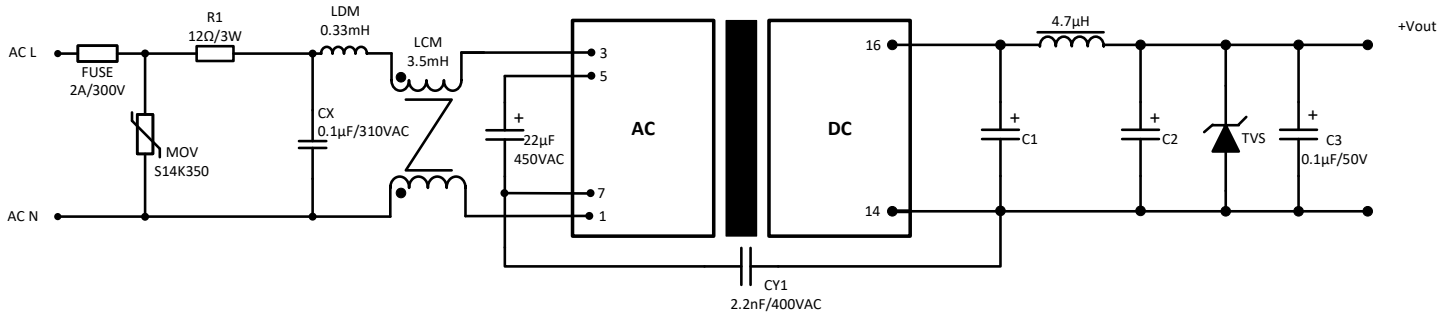

## Recommended EMC circuit for EFT Class IV, Surge L-G ±4KV

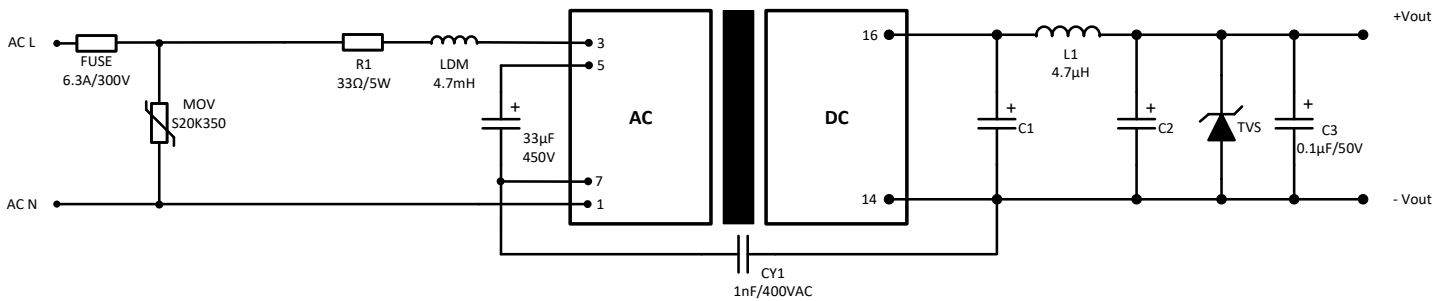

**OTE:** 1. Datasheets are updated as needed and as such, specifications are subject to change without notice. Once printed or downloaded, datasheets are no longer controlled by Aimtec; refer to [www.aimtec.com](http://www.aimtec.com) for the most current product specifications. 2. Product labels shown, including safety agency certifications on labels, may vary based on the date manufactured. 3. Mechanical drawings and specifications are for reference only. 4. All specifications are measured at an ambient temperature of 25°C, humidity<75%, nominal input voltage and at rated output load unless otherwise specified. 5. Aimtec may not have conducted destructive testing or chemical analysis on all internal components and chemicals at the time of publishing this document. CAS numbers and other limited information are considered proprietary and may not be available for release. 6. This product is not designed for use in critical life support systems, equipment used in hazardous environments, nuclear control systems or other such applications which necessitate specific safety and regulatory standards other than the ones listed in this datasheet. 7. Warranty is in accordance with Aimtec's standard Terms of Sale available at [www.aimtec.com](http://www.aimtec.com).