

# High Performance RFI Filters for Switching Power Supplies



AMI-M11S/M11T, M12W/M12X/M12Y Series  
Metal Enclosure Single Phase Single Stage Filters

AMI Designation	Input/output Style				Current Rating	Inductance mH	Capacitance		Resistor K $\Omega$	Leakage Current @ 120 VAC 60Hz/250 VAC 50 Hz mA	TIL Insertion Loss	Case Style
	6.3mm Spade Terminals	Wire Leads	Threaded Bolts	IEC			Cx nF	Cy pF				
AMI-M11S-1-3-C	1	-	-	-	3	36.8	940	4000	330	0.30/0.50	001	A
AMI-M11S-1-6-C	1	-	-	-	6	18.5	940	4000	330	0.30/0.50	002	A
AMI-M12W-1-10-C	1	-	-	-	10	9.5	1770	4000	165	0.30/0.50	003	A
AMI-M12X-1-15-C	1	-	-	-	15	5.07	2072	4000	165	0.30/0.50	004	B
AMI-M12Y-1-20-C	1	-	-	-	20	3.88	2770	4000	110	0.30/0.50	005	B
AMI-M11S-3-3-C	-	3	-	-	3	36.8	940	4000	330	0.30/0.50	001	C
AMI-M11S-3-6-C	-	3	-	-	6	18.5	940	4000	330	0.30/0.50	002	C
AMI-M12W-3-10-C	-	3	-	-	10	9.5	1770	4000	165	0.30/0.50	003	C
AMI-M11S-7-3-C	-	-	-	7	3	36.8	940	4000	330	0.30/0.50	001	E
AMI-M11T-7-6-C	-	-	-	7	6	18.5	1089	4000	330	0.30/0.50	002	E
AMI-M12X-6-15-C	-	-	6	-	15	5.07	2072	4000	165	0.30/0.50	004	D
AMI-M12Y-6-20-C	-	-	6	-	20	3.88	2770	4000	110	0.30/0.50	005	D
AMI-M12W-1-10-D	1	-	-	-	10	9.5	1770	10000	165	0.75/1.2	006	A
AMI-M12X-1-15-D	1	-	-	-	15	5.07	2075	15000	165	0.75/1.2	007	B
AMI-M12Y-1-20-D	1	-	-	-	20	3.88	2770	15000	110	0.75/1.2	008	B
AMI-M12W-3-10-D	-	3	-	-	10	9.5	1770	10000	165	0.75/1.2	006	C
AMI-M12X-6-15-D	-	-	6	-	15	5.07	2075	15000	165	0.75/1.2	007	D
AMI-M12Y-6-20-D	-	-	6	-	20	3.88	2770	15000	110	0.75/1.2	008	D

# High Performance RFI Filters for Switching Power Supplies

## Electrical Schematic

AMI-M11T (AMI-M11T-7-6-C)

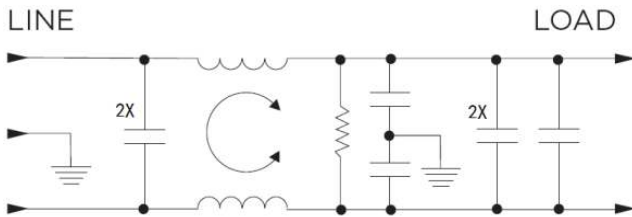

AMI-M12W (AMI-M12W-X-10-X)

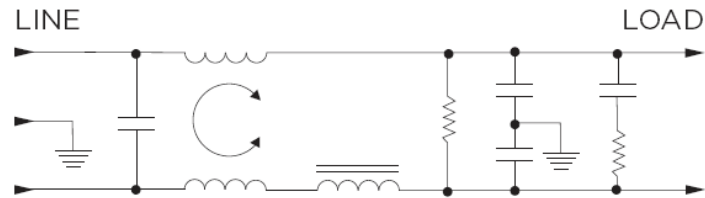

AMI-M12X (AMI-M12X-X-20-X)

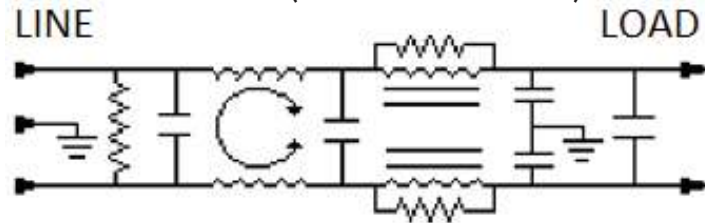

AMI-M12Y (AMI-M12Y-X-15-X)

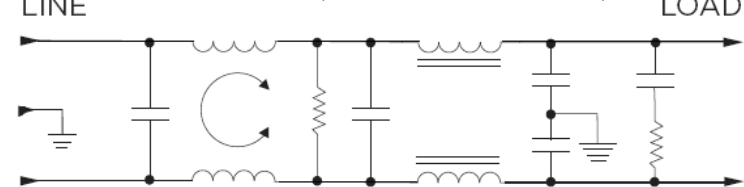

# High Performance RFI Filters for Switching Power Supplies

## Specifications:

- Rated Voltage (max): 250 VAC
- Operating Frequency: 50/60 Hz
- Operating Current: 3 to 20 A
- Hi-pot Rating (one minute): Line to Ground: 2250 VDC  
Line to Line: 1450 VDC
- Operating Ambient Temperature Range (at rated current  $I_r$ ): -10°C to +40°C. In an ambient temperature ( $T_a$ ) higher than +40°C the maximum operating current ( $I_o$ ) is calculated as follows:  $I_o = I_r \sqrt{[(85-T_a)/45]}$

## Performance Data Typical Insertion Loss

Measured in closed 50 Ohm system

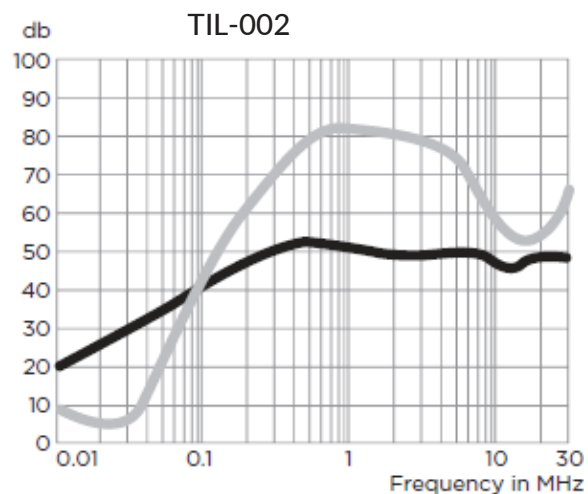
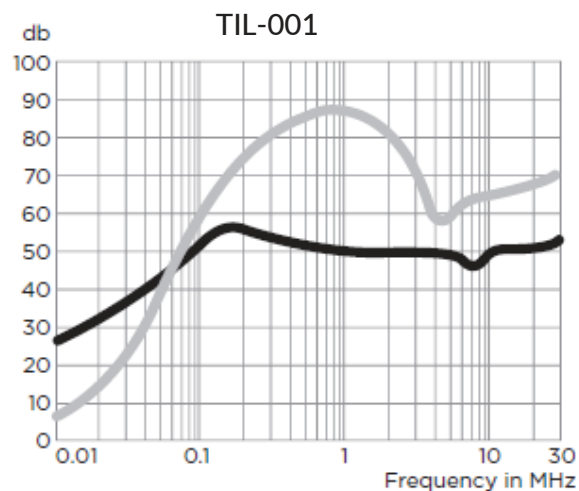

# High Performance RFI Filters for Switching Power Supplies

## Performance Data Typical Insertion Loss

Measured in closed 50 Ohm system

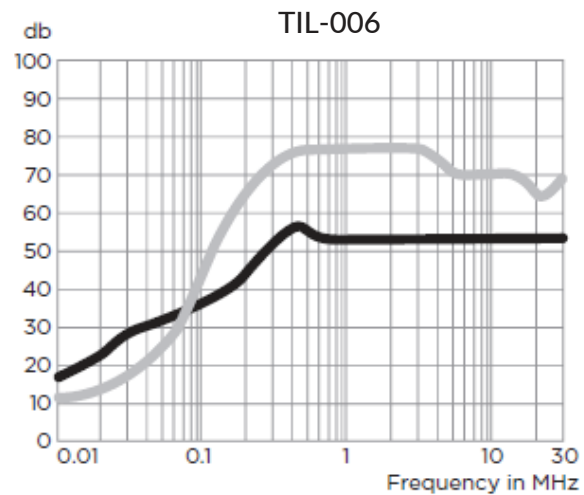
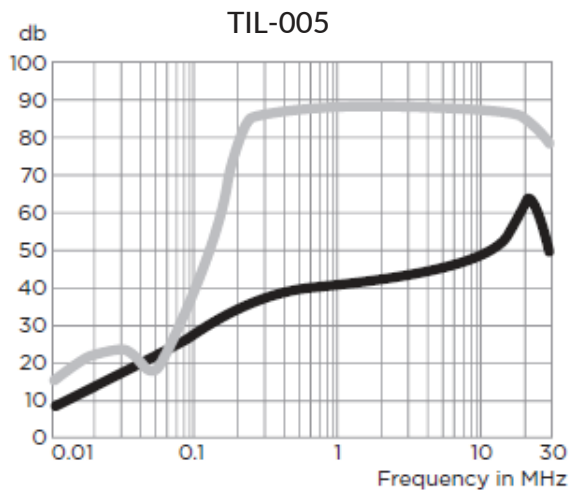
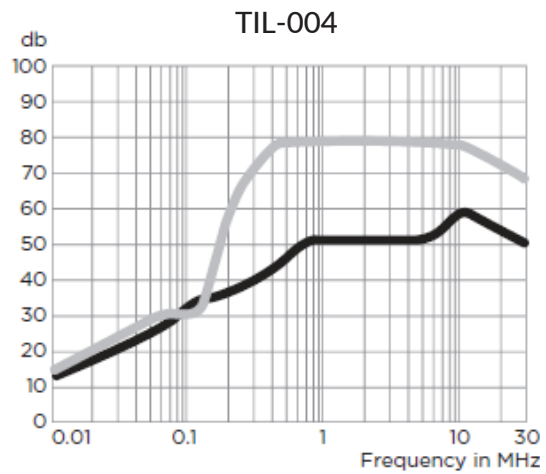
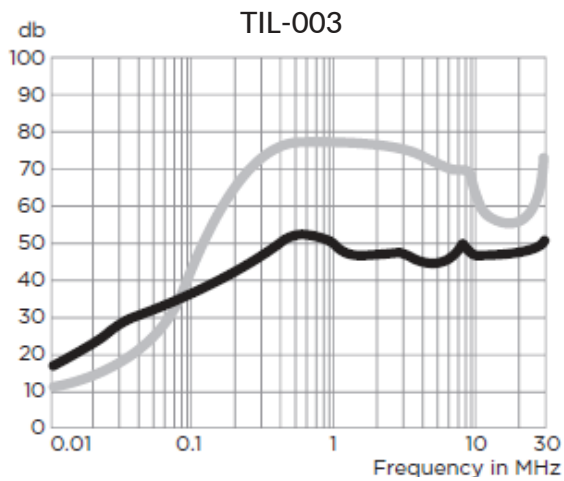

# High Performance RFI Filters for Switching Power Supplies

## Performance Data Typical Insertion Loss

Measured in closed 50 Ohm system

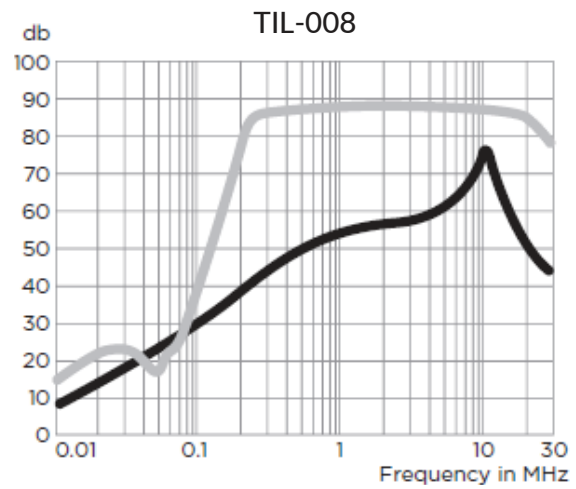
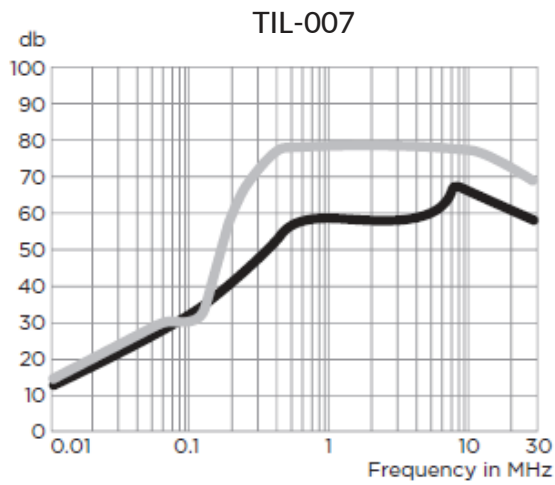

— Common Mode / Asymmetrical (L-G)  
— Differential Mode / Symmetrical (L-L)

# High Performance RFI Filters for Switching Power Supplies

## Minimum Insertion Loss

Measured in closed 50 Ohm system

### Common Mode/Asymmetrical (Line to Ground)

Current Rating	Frequency-MHz										
	.01	.03	.05	.15	.5	1	2	5	10	20	30
AMI-M11S-X-3-C	22	32	36	46	47	44	43	40	42	42	42
AMI-M11S-X-6-C AMI-M11T-7-6-C	16	26	30	41	47	44	43	43	40	42	42
AMI-M12W-X-10-C	12	22	26	36	47	42	42	40	42	42	45
AMI-M12X-X-15-C	8	17	22	31	43	44	44	42	47	52	43
AMI-M12Y-X-20-C	3	12	17	26	34	36	37	37	42	47	38
AMI-M12W-X-10-D	12	22	26	38	52	50	50	50	50	50	50
AMI-M12X-X-15-D	8	17	22	33	52	52	52	52	57	45	35
AMI-M12Y-X-20-D	3	12	17	29	42	47	50	51	56	40	30

### Differential Mode/Symmetrical (Line to Line)

Current Rating	Frequency-MHz										
	.01	.03	.05	.15	.5	1	2	5	10	20	30
AMI-M11S-X-3-C	3	1	30	61	70	70	70	50	50	50	55
AMI-M11S-X-6-C AMI-M11T-7-6-C	4	2	14	51	70	70	70	65	47	50	55
AMI-M12W-X-10-C	7	12	17	52	70	70	70	65	55	50	60
AMI-M12X-X-15-C	12	19	15	51	70	70	70	70	70	65	60
AMI-M12Y-X-20-C	10	17	13	51	70	70	70	70	67	65	60
AMI-M12W-X-10-D	7	12	17	52	70	70	70	65	65	50	65
AMI-M12X-X-15-D	12	19	15	51	70	70	70	70	70	65	60
AMI-M12Y-X-20-D	10	17	13	51	70	70	70	70	67	65	60

# High Performance RFI Filters for Switching Power Supplies

## Case Styles

### STYLE A

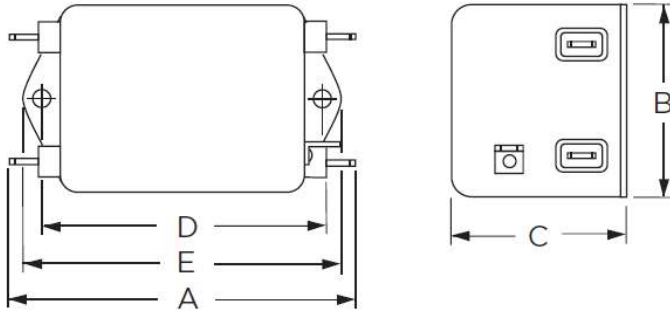

Typical Dimensions:

- Line/Load Terminals (4): .250 [6.3] with .07 [1.8] Dia. hole
- Ground Terminal (1): .250 [6.3] with .07 x .16 [1.8 x 3.8] slot
- Mounting Holes (2): .188 [4.78] Dia.

### STYLE B

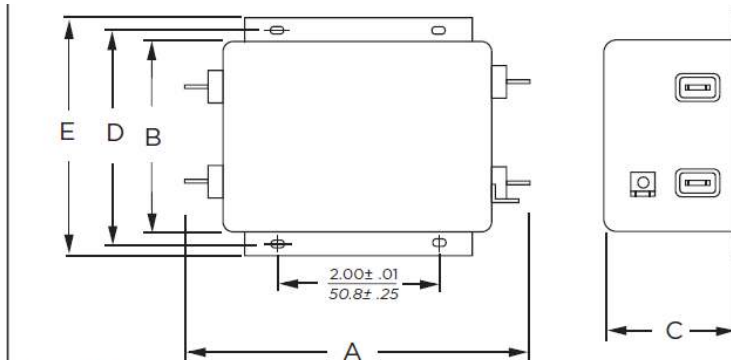

Typical Dimensions:

- Line/Load Terminals (4): .250 [6.3] with .07 [1.8] Dia. hole
- Ground Terminal (1): .250 [6.3] with .07 x .16 [1.8 x 3.8] slot
- Mounting Slots (4): .250 x .156 [6.35 x 3.96] Dia.

# High Performance RFI Filters for Switching Power Supplies

## Case Styles

### STYLE C

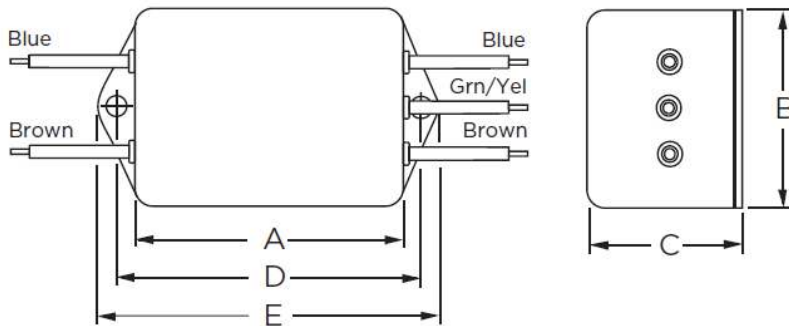

Typical Dimensions:

Wire Leads (5): 4.0 [101.6] Min., AWG18  
Mounting Holes (2): .188 [4.78] Dia.

### STYLE D

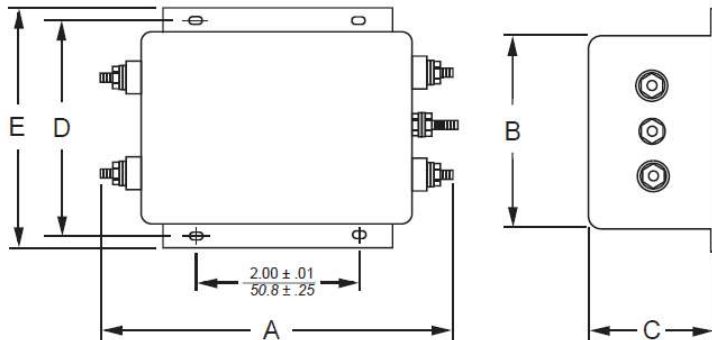

Typical Dimensions:

Terminals (5): 8-32, Torque 18 lbf-in. [2.03 N-m] max.  $\pm 2$  [.22]  
Mounting Slots (4): .250 x .156 [6.35 x 3.96] Dia.



# High Performance RFI Filters for Switching Power Supplies

## Case Styles

### STYLE E

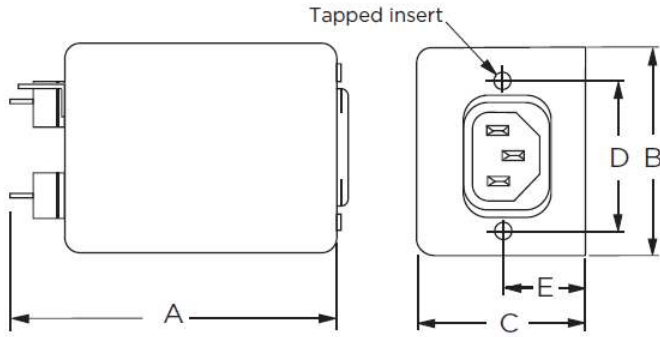

#### Typical Dimensions:

Load Terminals (2):	.250 [6.3] with .07 [1.8] Dia. hole
Ground Terminal (1):	.250 [6.3] with .07 x .16 [1.8 x 3.8] slot
Line Inlet (1):	IEC 60320-1 C14
Tapped Inserts (2):	6-32 x 1/4

## Recommended Panel Cutout

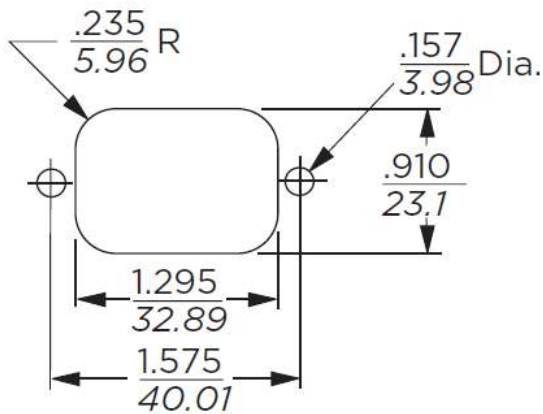

Tolerance  $\pm .005$  [0.13]

# High Performance RFI Filters for Switching Power Supplies

## Mechanical Dimensions:

Model Number	A max	B max	C max	D $\begin{smallmatrix} \pm .015 \\ \pm .38 \end{smallmatrix}$	E max
AMI-M11S-1-3/6-C	3.56"/90.4mm	2.15"/54.6mm	1.81"/46.0mm	2.938"/74.63mm	3.38"/85.9mm
AMI-M11S-3-3/6-C	2.55"/64.8mm	2.15"/54.6mm	1.81"/46.0mm	2.938"/74.63mm	3.38"/85.9mm
AMI-M11S-7-3-C AMI-M11T-7-6-C	3.52"/89.4mm	2.25"/57.2mm	1.78"/45.2mm	1.575"/40.01mm	*0.63"/16.0mm
AMI-M12W-1-10-X	4.69"/119.1mm	2.27"/57.7mm	1.80"/45.7mm	4.063"/103.2mm	4.47"/113.5mm
AMI-M12W-3-10-X	3.69"/93.7mm	2.27"/57.7mm	1.80"/45.7mm	4.063"/103.2mm	4.47"/113.5mm
AMI-M12X/M12Y-1-15/20-X	5.45"/138.4mm	3.12"/79.2mm	2.18"/55.4mm	3.5"/88.9mm	3.96"/100.6mm
AMI-M12X/M12Y-6-15/20-X	5.95"/151.1mm	3.12"/79.2mm	2.18"/55.4mm	3.5"/88.9mm	3.96"/100.6mm

\*±0.02/0.5