

PHE820MB5100MR17

Aliases (F720BD103M275A)

Not for New Design • Recommended Replacement Series R46 X2 310 VAC

PHE820M/F720, Film, Metallized Polyester, Safety, 0.01 uF, 20%, 275 VAC (X2), 760 VDC, 100°C, Lead Spacing = 15mm

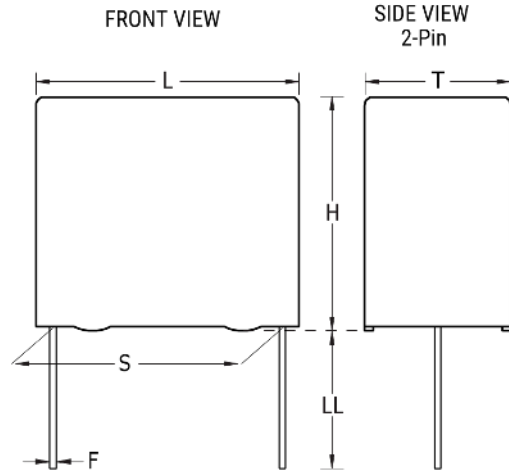

Click [here](#) for the 3D model.

General Information	
Series	PHE820M/F720
Dielectric	Metallized Polyester
Style	Radial
Features	EMI Safety
RoHS	Yes
Lead	Wire Leads
Safety Class	X2
Qualifications	ENEC, UL, cUL
AEC-Q200	No
THB Performance	No
Component Weight	1.615 g
Miscellaneous	SRF= 13 MHz.
Notes	Not for new design – the replacement series is: R46 X2 310VAC.

Specifications	
Capacitance	0.01 uF
Capacitance Tolerance	20%
Voltage AC	275 VAC (X2)
Voltage DC	760 VDC
Temperature Range	-40/+100°C
Rated Temperature	100°C
Dissipation Factor	1% 1kHz
Insulation Resistance	30 GOhms
Max dV/dt	100 V/us

Dimensions	
L	18mm MAX
H	10.5mm MAX
T	5.5mm MAX
S	15mm +/-0.4mm
LL	17mm -1mm
F	0.8mm NOM
G	0.5mm NOM

Packaging Specifications	
Packaging	Bulk, Bag
Packaging Quantity	800

Statements of suitability for certain applications are based on our knowledge of typical operating conditions for such applications, but are not intended to constitute - and we specifically disclaim - any warranty concerning suitability for a specific customer application or use. This Information is intended for use only by customers who have the requisite experience and capability to determine the correct products for their application. Any technical advice inferred from this Information or otherwise provided by us with reference to the use of our products is given gratis, and we assume no obligation or liability for the advice given or results obtained.