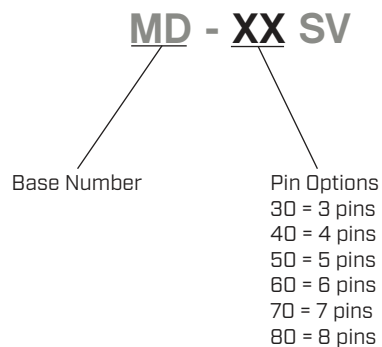

SERIES: MD-SV | **DESCRIPTION:** MINI DIN CONNECTOR**FEATURES**

- PCB mount
- vertical mount
- 3-8 pins

**PART NUMBER KEY****SPECIFICATIONS**

parameter	conditions/description	min	typ	max	units
rated input voltage			100 12		Vac Vdc
rated input current	at 100 Vac at 12 Vdc			1 2	A A
contact resistance				30	mΩ
insulation resistance	at 250 Vdc	50			MΩ
voltage withstand	for 1 minute			250	Vac
insertion force		0.8		6.0	kg
withdrawal force		0.8		4.5	kg
operating temperature		-20		85	°C
life			1,000		cycles
flammability rating	UL94V-0				
RoHS	yes				

MECHANICAL DRAWINGS (MD-30SV, MD-40SV, MD-50SV)

units: mm
 tolerance: ± 0.3 mm
 PCB: ± 0.1 mm
 unless otherwise noted

ITEM	DESCRIPTION	MATERIAL	PLATING/COLOR
1	body	PBT (UL94V-0)	black
2	earth terminal	brass	tin
3	terminals	phosphor bronze	silver

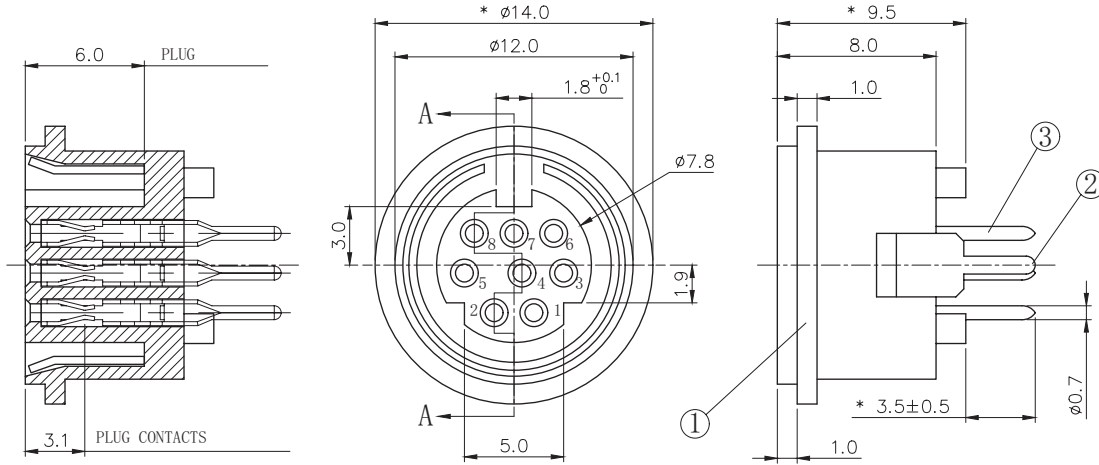

A-A

MD-30SV

MD-40SV

MD-50SV

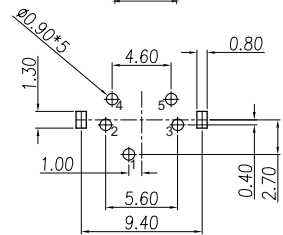
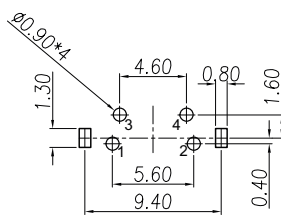
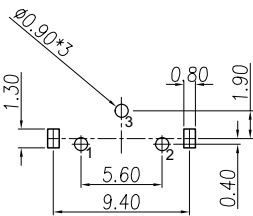
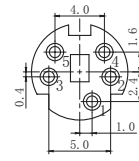
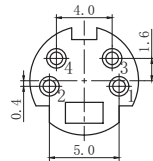
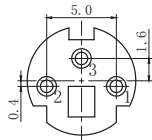

Recommended PCB Layout
 Bottom View
 [Date Codes prior to 03/03/2022]

Recommended PCB Layout
 Bottom View
 [Date Codes prior to 03/03/2022]

Recommended PCB Layout
 Bottom View
 [Date Codes prior to 03/03/2022]

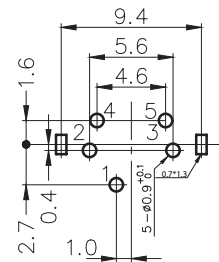
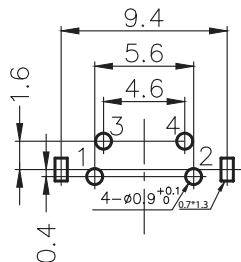
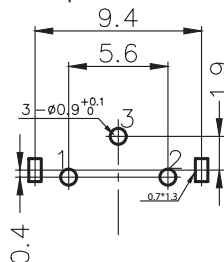

Recommended PCB Layout
 Bottom View
 [Date Codes after 03/03/2022]

Recommended PCB Layout
 Bottom View
 [Date Codes after 03/03/2022]

Recommended PCB Layout
 Bottom View
 [Date Codes after 03/03/2022]

MECHANICAL DRAWINGS (MD-60SV, MD-70SV, MD-80SV)

units: mm
 tolerance: ±0.3 mm
 PCB: ±0.1 mm
 unless otherwise noted

ITEM	DESCRIPTION	MATERIAL	PLATING/COLOR
1	body	PBT (UL94V-0)	black
2	earth terminal	brass	tin
3	terminals	phosphor bronze	silver

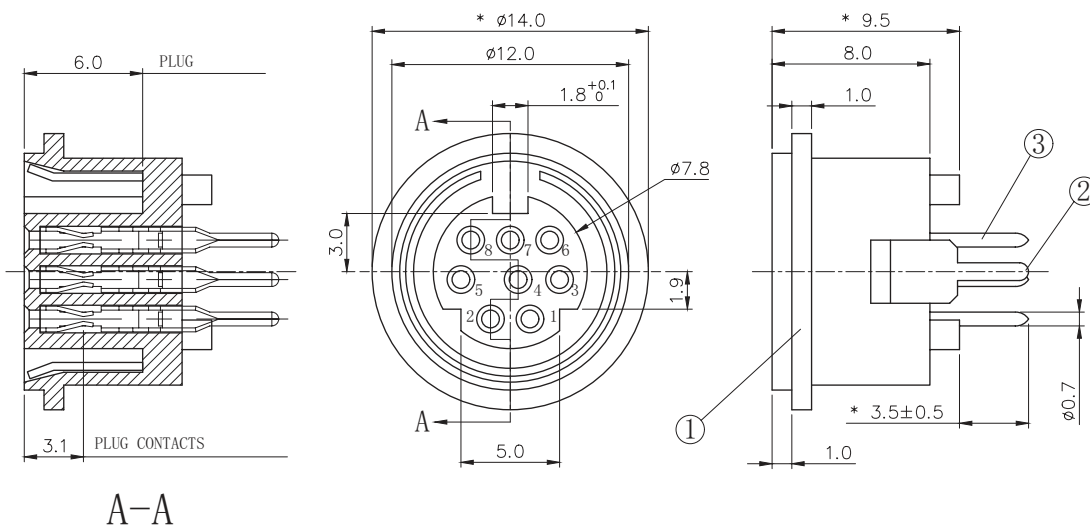

MD-60SV

MD-70SV

MD-80SV

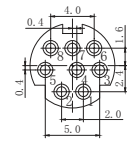
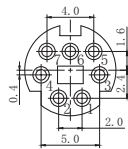
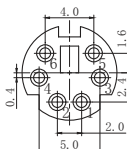

Recommended PCB Layout
 Bottom View
 [Date Codes prior to 03/03/2022]

Recommended PCB Layout
 Bottom View
 [Date Codes prior to 03/03/2022]

Recommended PCB Layout
 Bottom View
 [Date Codes prior to 03/03/2022]

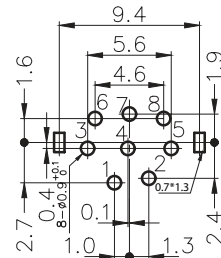
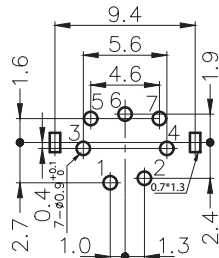
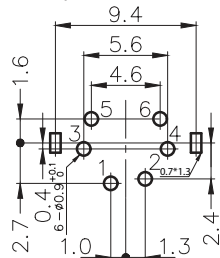

Recommended PCB Layout
 Bottom View
 [Date Codes after 03/03/2022]

Recommended PCB Layout
 Bottom View
 [Date Codes after 03/03/2022]

Recommended PCB Layout
 Bottom View
 [Date Codes after 03/03/2022]

REVISION HISTORY

rev.	description	date
1.0	initial release	02/23/2006
1.01	new template applied	03/07/2012
1.02	updated datasheet	08/25/2017
1.03	updated housing, added 7 pin version, brand update	10/08/2019
1.04	modified design, changed factory	02/18/2022
1.05	logo, datasheet style update	08/05/2022

The revision history provided is for informational purposes only and is believed to be accurate.



CUI Devices offers a one (1) year limited warranty. Complete warranty information is listed on our website.

CUI Devices reserves the right to make changes to the product at any time without notice. Information provided by CUI Devices is believed to be accurate and reliable. However, no responsibility is assumed by CUI Devices for its use, nor for any infringements of patents or other rights of third parties which may result from its use.

CUI Devices products are not authorized or warranted for use as critical components in equipment that requires an extremely high level of reliability. A critical component is any component of a life support device or system whose failure to perform can be reasonably expected to cause the failure of the life support device or system, or to affect its safety or effectiveness.

cuiddevices.com