

Instruction manual for Evaluation Board of TB67S265FTG

July 9, 2018

Re v.1.1

【Outline】

The TB67S265 is a two-phase bipolar stepping motor driver using a PWM chopper. 3 line serial interface control system and BiCD process are adopted. Rating of 50V and 2.0A is realized.

This evaluation board mounts necessary components to evaluate the IC. Each excitation drive of full step and half step with PWM constant current drive. Please try to operate the stepping motor.

【Note】

In using, please be careful about thermal condition sufficiently.
As for each control signal, please refer to the IC specification by accessing to the below URL.

<http://toshiba.semicon-storage.com/jp/product/linear/motordriver/detail.TB67S265FTG.html>

Further, the application of this evaluation board is limited to the purpose of evaluating and learning the motor control. Please do not ship them to a market.

Connection to Evaluation board

Corresponding table

(Silk name vs. Signal name)

(Note) Silk name and signal name on the board are different because the series products have the common board.

Silk name	Signal name
L_OUT	L_OUT
38	C_OUT
39	D_OUT
VREFB	VREFB
42	VREFA
OSCM	OSCM
44	NC
45	SI
46	SCK
47	RCK
2	SCLR-
3	G-
4	STANDBY

Power source of VM (10V to 47V)

Two-phase bipolar type Stepping motor

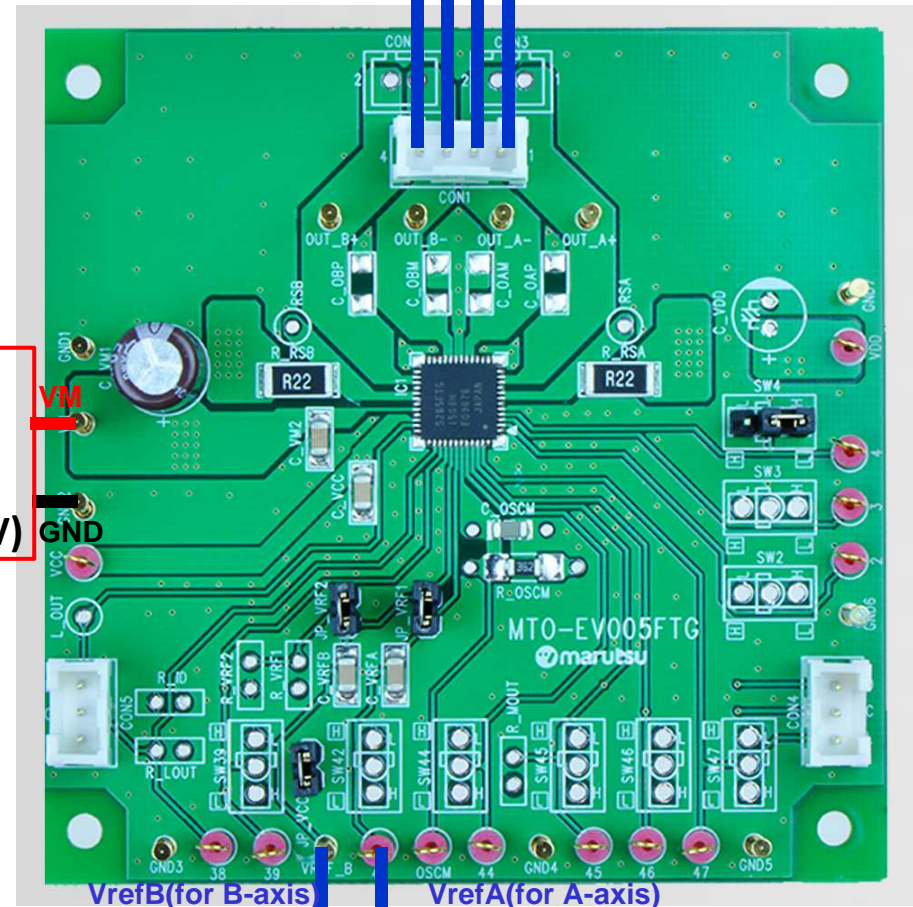

Reference voltage for motor current set Vref (0V to 3.6V)

Setting evaluation board 1

Setting motor current

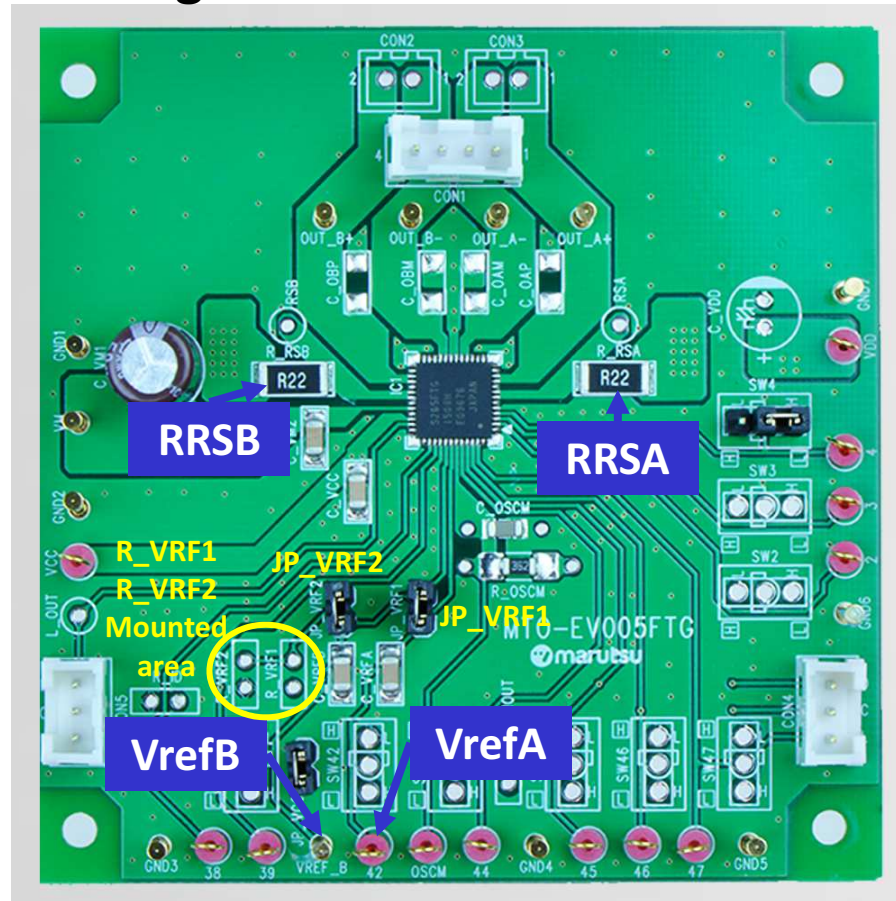

Setting motor current

$$I_{out(max)} = V_{REF(gain)} \times \frac{V_{ref(V)}}{R_{RS}(\Omega)}$$

VREF(gain): Decay ratio of VREF: 1/5.0 (typ.)

RRS=0.22Ω

VREF of A-axis and B-axis are made common by short the jumper (JP_VRF1) and the both voltages are possible to input from VREFA pin. And Vref can be generated from the internal regulator (VCC) by mounting the divider resistance to R_VRF1 and R_VRF2 and short-circuiting JP_VRF2.

Waveform of motor current

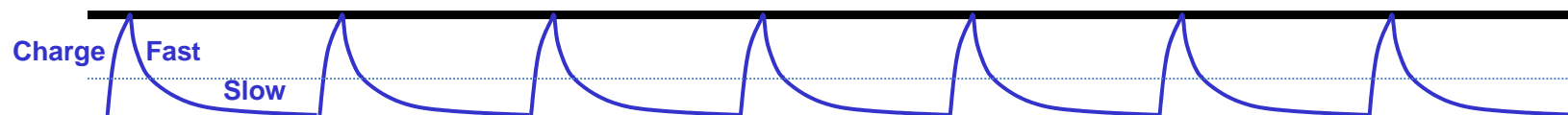

Current value of setting motor

Setting evaluation board2

Setting chopping frequency of the constant current of the motor

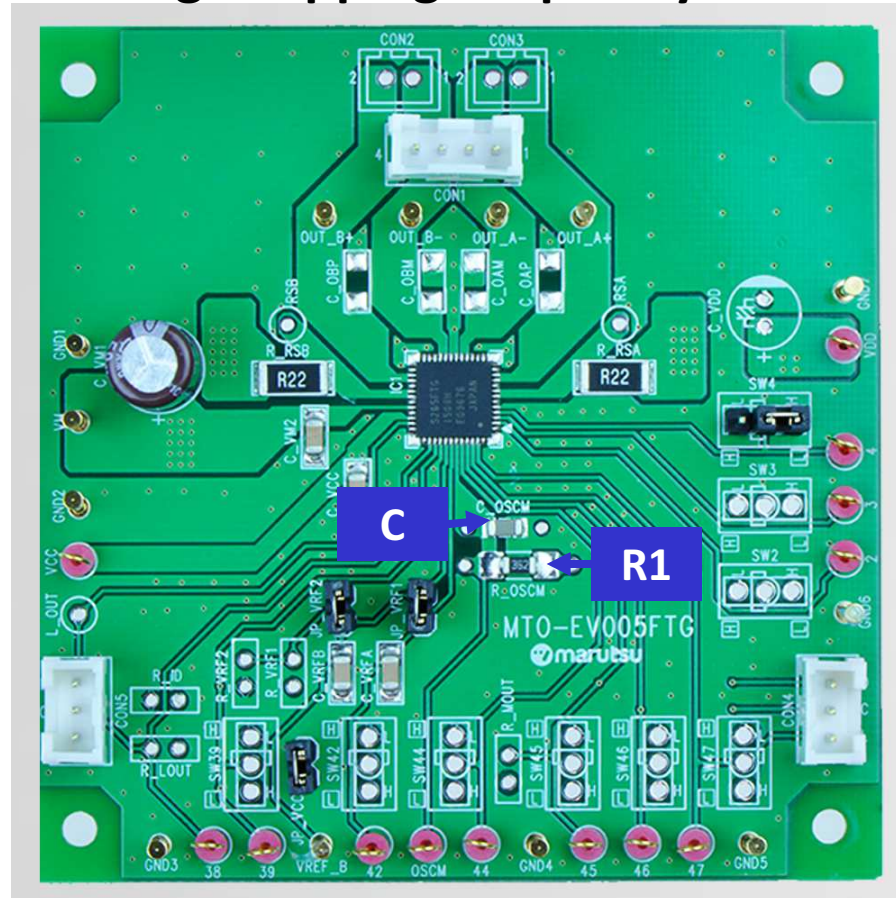

Formula of setting chopping frequency

$$f_{OSCM} = 1 / [0.56 \times \{C \times (R1 + 500)\}]$$

$$f_{chop} = f_{OSCM} / 16$$

Recommended frequency range:

f_{chop} =40kHz to 150kHz

100kHz configuration

Mounted parts are as follows;

Capacitor (C=270pF), Resistance (R1=3.6kΩ)

Waveform of motor current

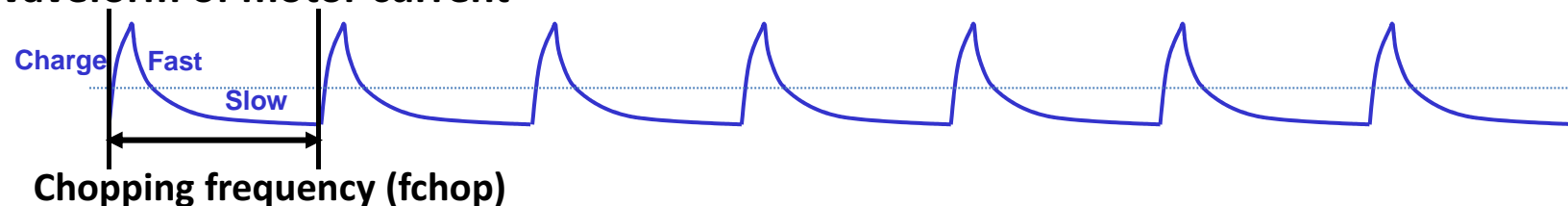

Setting evaluation board3

Setting motor operation

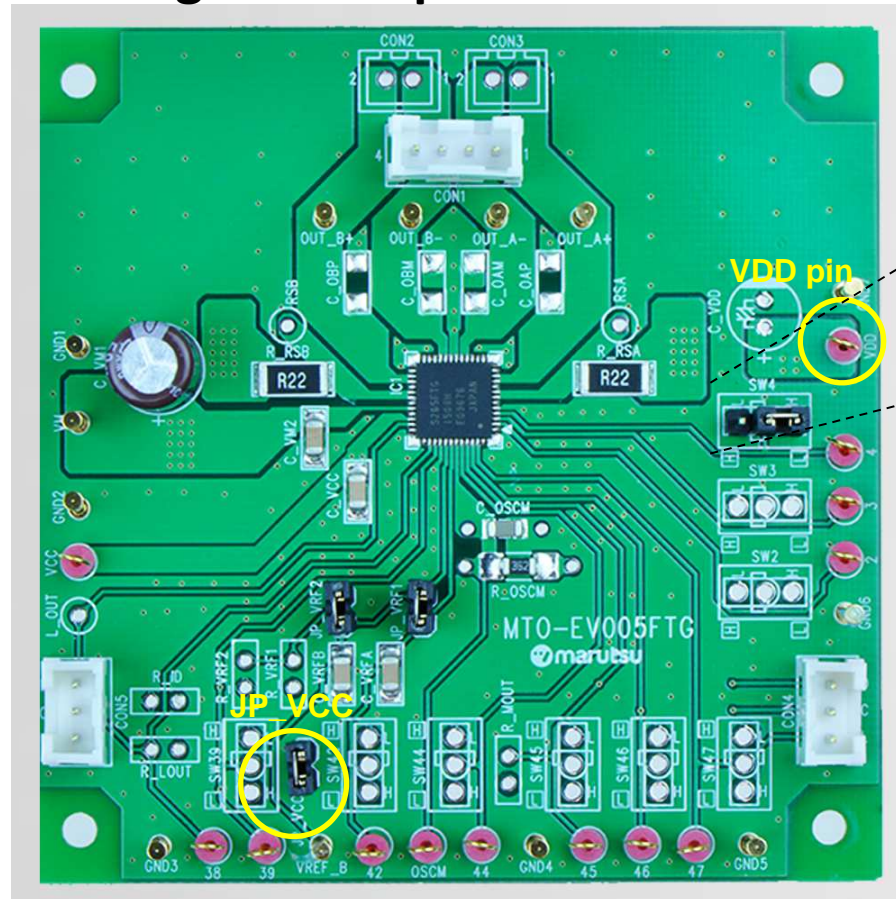

【Enhanced figure of jumper part】

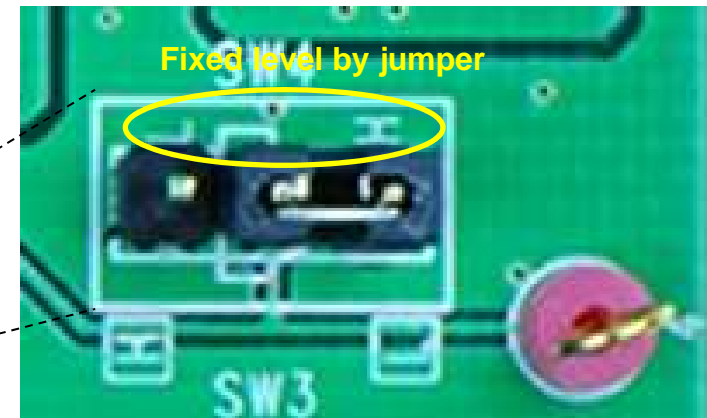

Jumper indicated above is adopted on this evaluation board to set operation of the TB67S265FTG.

To select the function by the jumper, short-circuit JP_VCC or supply the voltage of high level by VDD pin.

In above, fixed level of the silk near the jumper is indicated inside the white frame. Please change the short position according to the configuration of the usage function.

In case of inputting the signal externally, please remove the short pin.

Circuit of evaluation board

