

# CNZ3731, CNC7C501, CNZ3734, CNC2S501, CNC7C502, CNC7H501 (ON3731, ON3732, ON3734, ON3731A, ON3732A, ON3734A)

## Optoisolators

### Overview

The CNZ3731 series of optoisolators consist of a GaAs infrared LED which is optically coupled with a Si NPN Darlington phototransistor, and housed in a small DIL package. The series provides high I/O isolation voltage and high collector/emitter isolation voltage, as well as a high current transfer ratio (CTR). This opto isolator series also includes the two-channel CNC7C501 and the four-channel CNZ3734, and A type of these models with increased collector to emitter breakdown voltage ( $V_{CEO} > 350V$ ).

### Features

- High collector to emitter breakdown voltage :  $V_{CEO} > 300 V$ ,  
A type :  $V_{CEO} > 350 V$
- High current transfer ratio with Darlington phototransistor output :  
CTR = 4000% (typ.)
- High I/O isolation voltage :  $V_{ISO} \geq 5000 V_{rms}$
- Small DIL package for saving mounting space
- UL listed (UL File No. E79920)
- A-type models have a guaranteed internal insulating distance of 0.4 mm

### Applications

- Telephones
- Telephone exchange
- FAX
- Programmable controllers
- Signal transfer between circuits with different potentials and impedances

### Pin Connection

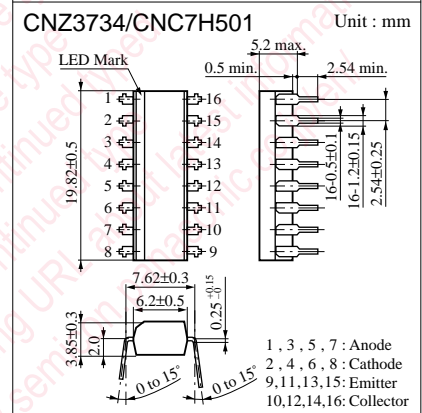
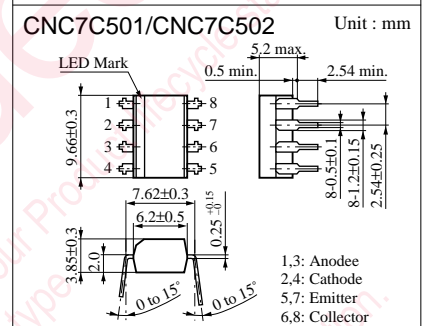
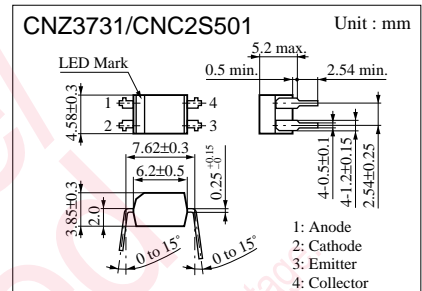
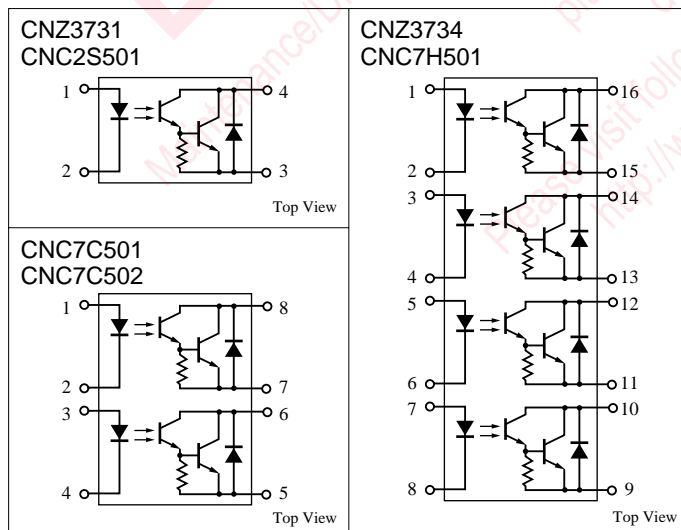

(Note) The part numbers in the parenthesis show conventional part number.

**Absolute Maximum Ratings (Ta = 25°C)**

Parameter		Symbol	Ratings				Unit
			CNZ3731	CNC7C501 CNZ3734	CNC2S501	CNC7C502 CNC7H501	
Input (Light emitting diode)	Reverse voltage (DC)	$V_R$	6		6		V
	Forward current (DC)	$I_F$	50		50		mA
	Pulse forward current	$I_{FP}^{*1}$	1		1		A
	Power dissipation	$P_D^{*2}$	75		75		mW
Output (Photo transistor)	Collector current	$I_C$	150		150		mA
	Collector to emitter voltage	$V_{CEO}$	300		350		V
	Emitter to collector voltage	$V_{ECO}$	0.3		0.3		V
	Collector power dissipation	$P_C^{*3}$	300	150	300	150	mW
Total power dissipation		$P_T$	320	200	320	200	mW
Isolation voltage, input to output		$V_{ISO}^{*4}$	5000		5000		$V_{rms}$
Operating ambient temperature		$T_{opr}$	-30 to +100		-30 to +100		°C
Storage temperature		$T_{stg}$	-55 to +125		-55 to +125		°C

\*1 Pulse width  $\leq 100 \mu s$ , repeat 100 pps

\*2 Input power derating ratio is 0.75 mW/°C at  $T_a \geq 25^\circ C$ .

\*3 Output power derating ratio is 3.0 mW/°C at  $T_a \geq 25^\circ C$  (CNZ3731, CNC2S501).

Output power derating ratio is 0.75 mW/°C at  $T_a \geq 25^\circ C$  (CNC7C501, CNC2S502, CNZ3734, CNC7H501).

\*4 AC 1min., RH < 60 %

**Electrical Characteristics (Ta = 25°C)**

Parameter		Symbol	Conditions	min	typ	max	Unit
Input characteristics	Reverse current (DC)	$I_R$	$V_R = 3V$			10	$\mu A$
	Forward voltage (DC)	$V_F$	$I_F = 50mA$		1.35	1.5	V
	Capacitance between pins	$C_t$	$V_R = 0V, f = 1MHz$		30		pF
Output characteristics	Collector cutoff current	$I_{CEO}$	$V_{CE} = 200V$			200	nA
	Collector to emitter capacitance	$C_C$	$V_{CE} = 10V, f = 1MHz$		10		pF
Transfer characteristics	DC current transfer ratio	$CTR^{*1}$	$V_{CE} = 2V, I_F = 1mA$	1000	4000		%
	Isolation capacitance, input to output	$C_{ISO}$	$f = 1MHz$		0.7		pF
	Isolation resistance, input to output	$R_{ISO}$	$V_{ISO} = 500V$	$10^{11}$			$\Omega$
	Rise time	$t_r^{*2}$	$V_{CC} = 10V, I_C = 10mA,$		40		$\mu s$
	Fall time	$t_f^{*3}$	$R_t = 100\Omega$		15		$\mu s$
Collector to emitter saturation voltage		$V_{CE(sat)}$	$I_F = 1mA, I_C = 2mA$			1.0	V

\*1 DC current transfer ratio (CTR) is a ratio of output current against DC input current.

$$CTR = \frac{I_C}{I_F} \times 100 (\%)$$

\*2  $t_r$ : Time required for the collector current to increase from 10% to 90% of its final value

\*3  $t_f$ : Time required for the collector current to decrease from 90% to 10% of its initial value

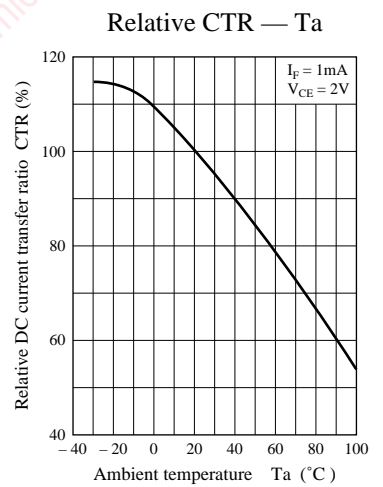
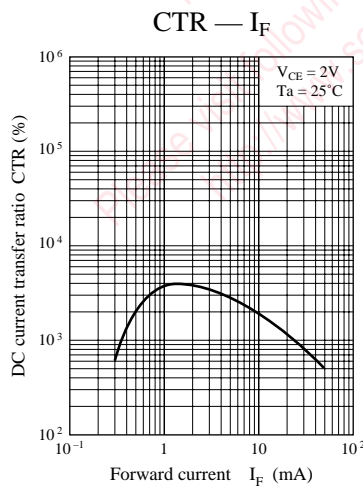
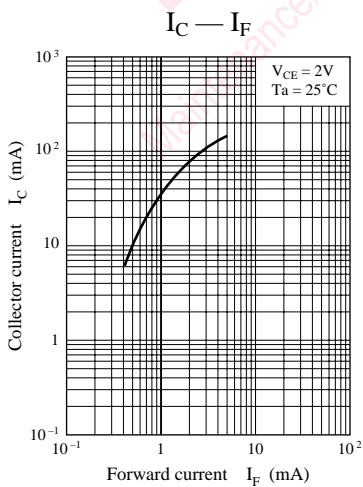
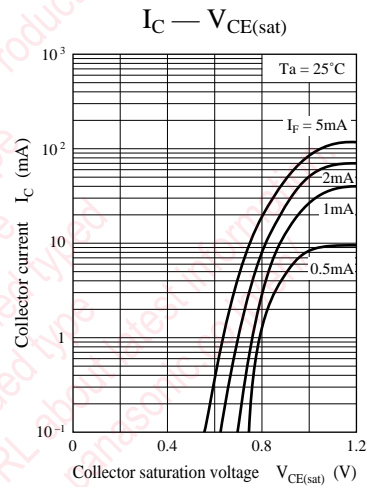
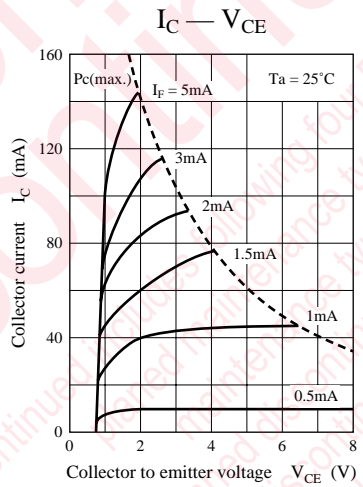
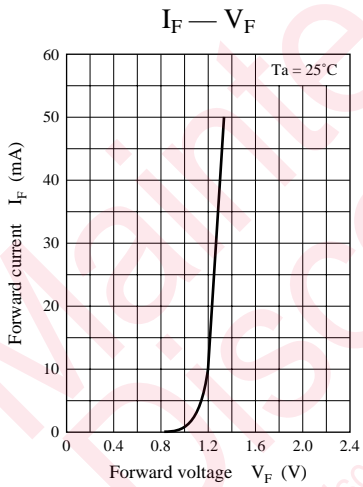
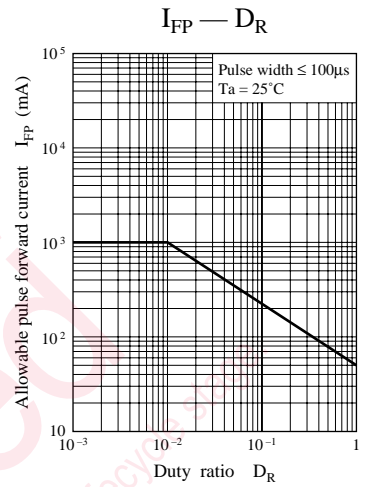
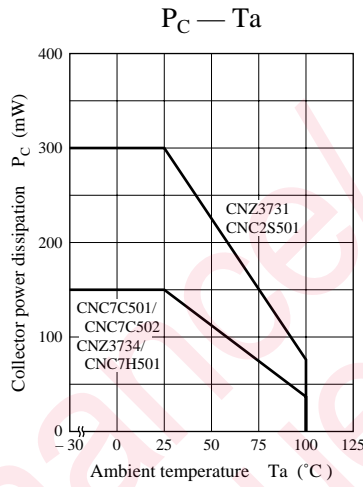
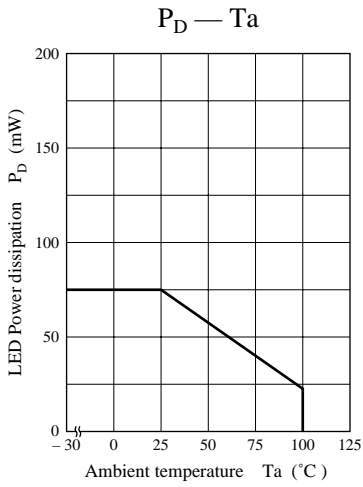

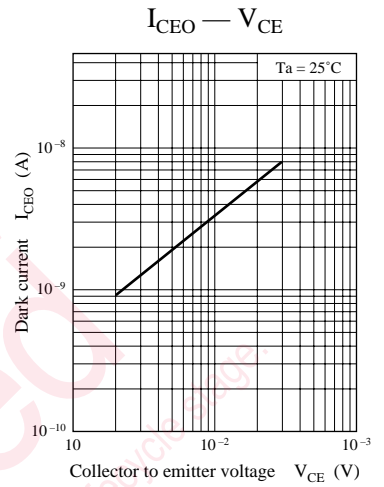
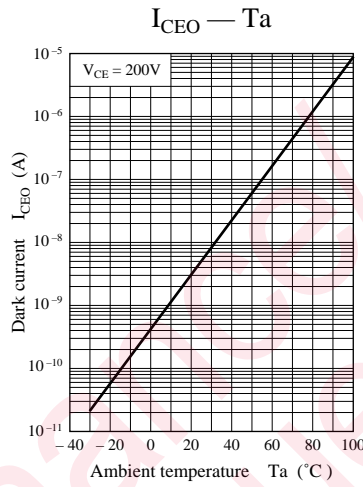
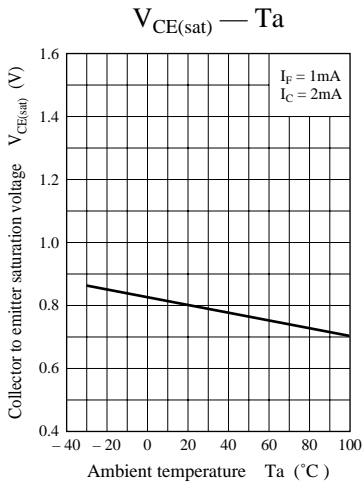

**Response time — External load resistance characteristics**

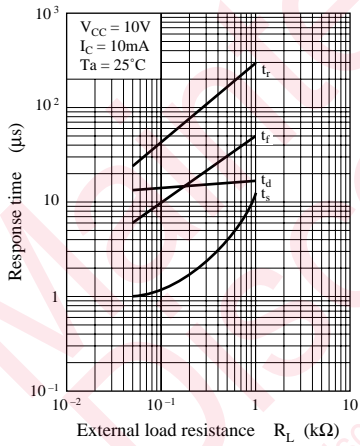

**Response time measurement circuit**

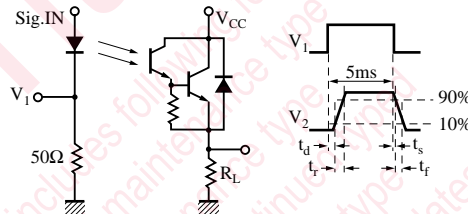

**Frequency characteristics**

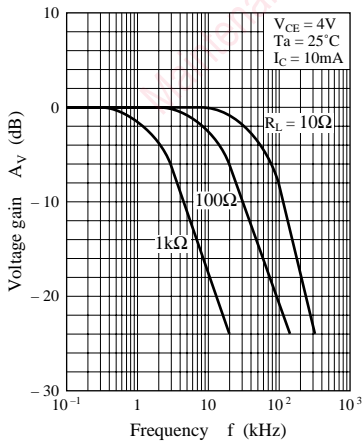

**Measurement circuit of frequency characteristics**

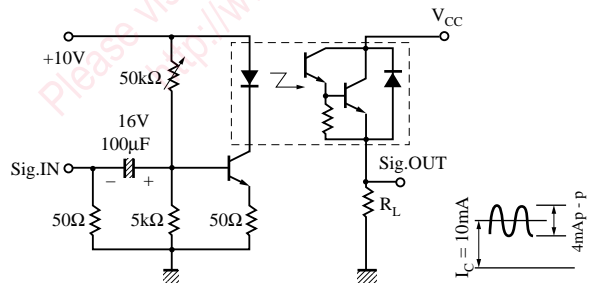

# Caution for Safety

 **DANGER**

## ■ This product contains Gallium Arsenide (GaAs).

GaAs powder and vapor are hazardous to human health if inhaled or ingested. Do not burn, destroy, cut, cleave off, or chemically dissolve the product. Follow related laws and ordinances for disposal. The product should be excluded from general industrial waste or household garbage.

### Request for your special attention and precautions in using the technical information and semiconductors described in this book

- (1) If any of the products or technical information described in this book is to be exported or provided to non-residents, the laws and regulations of the exporting country, especially, those with regard to security export control, must be observed.
- (2) The technical information described in this book is intended only to show the main characteristics and application circuit examples of the products, and no license is granted under any intellectual property right or other right owned by our company or any other company. Therefore, no responsibility is assumed by our company as to the infringement upon any such right owned by any other company which may arise as a result of the use of technical information described in this book.
- (3) The products described in this book are intended to be used for standard applications or general electronic equipment (such as office equipment, communications equipment, measuring instruments and household appliances).  
Consult our sales staff in advance for information on the following applications:
  - Special applications (such as for airplanes, aerospace, automobiles, traffic control equipment, combustion equipment, life support systems and safety devices) in which exceptional quality and reliability are required, or if the failure or malfunction of the products may directly jeopardize life or harm the human body.
  - Any applications other than the standard applications intended.
- (4) The products and product specifications described in this book are subject to change without notice for modification and/or improvement. At the final stage of your design, purchasing, or use of the products, therefore, ask for the most up-to-date Product Standards in advance to make sure that the latest specifications satisfy your requirements.
- (5) When designing your equipment, comply with the range of absolute maximum rating and the guaranteed operating conditions (operating power supply voltage and operating environment etc.). Especially, please be careful not to exceed the range of absolute maximum rating on the transient state, such as power-on, power-off and mode-switching. Otherwise, we will not be liable for any defect which may arise later in your equipment.  
Even when the products are used within the guaranteed values, take into the consideration of incidence of break down and failure mode, possible to occur to semiconductor products. Measures on the systems such as redundant design, arresting the spread of fire or preventing glitch are recommended in order to prevent physical injury, fire, social damages, for example, by using the products.
- (6) Comply with the instructions for use in order to prevent breakdown and characteristics change due to external factors (ESD, EOS, thermal stress and mechanical stress) at the time of handling, mounting or at customer's process. When using products for which damp-proof packing is required, satisfy the conditions, such as shelf life and the elapsed time since first opening the packages.
- (7) This book may be not reprinted or reproduced whether wholly or partially, without the prior written permission of Matsushita Electric Industrial Co., Ltd.

If you have any inquiries or questions about this book or our semiconductor products, please contact one of our sales offices listed on the back or Semiconductor Company's Department.