

## Datasheet

Push-Button-SET Adjustable-Field Sensor



- Push-button adjustable-field background suppression sensor detects objects within a defined sensing field, while ignoring objects located beyond the sensing field cutoff
- Easy cutoff point push-button SET options: Background Suppression SET, Object Detection SET and Dynamic SET, plus manual adjustments
- Easy push-button N.O./N.C. and output OFF-delay setup
- Powerful, highly collimated visible red sensing beam
- Tough ABS housing is rated IEC IP67; NEMA 6
- Easy-to-read operating status indicators, with 8-segment bar graph display
- Bipolar discrete outputs, PNP and NPN
- Selectable 30 millisecond OFF-delay
- Models available with 2 m or 9 m (6.5 ft or 30 ft) cable or integral quick-disconnect
- Compact housing, mounting versatility – via popular 30 mm threaded barrel or side-mount



**WARNING:**

- **Do not use this device for personnel protection**
- Using this device for personnel protection could result in serious injury or death.
- This device does not include the self-checking redundant circuitry necessary to allow its use in personnel safety applications. A device failure or malfunction can cause either an energized (on) or de-energized (off) output condition.

## Models

Model	Cutoff	Cable <sup>1</sup>	Supply Voltage	Output Type	Sensing Mode	Sensing Beam
QS30AF	50 mm to 300 mm (2 in to 12 in)	2 m (6.5 ft) 5-wire cable	10 V DC to 30 V DC	Bipolar NPN/PNP	<p>DIFFUSE</p>	Visible red, 660 nm
QS30AFQ		Integral 5-pin Euro-style quick disconnect				

## Overview

The QS30AF is an easy-to-use triangulation sensor which provides a sophisticated, yet cost-effective solution for demanding applications. The sensor features two identically configured outputs, one NPN and one PNP. The sensor's compact housing has a large, easy-to-see bar graph display plus bright LEDs for easy configuration and status monitoring during operation. The sensor can be side-mounted, using its integral mounting holes, or front-mounted, via its 30 mm threaded barrel.

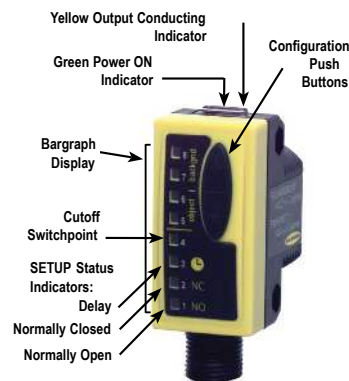

Figure 1. QS30 Features

<sup>1</sup> Integral 2 m (6.5 ft) unterminated cable models are listed.

- To order the 9 m (30 ft) PVC cable model, add the suffix "W/30" to the cabled model number. For example, QS30AF W/30.
- Models with a quick disconnect require a mating cordset.



## Optical Triangulation

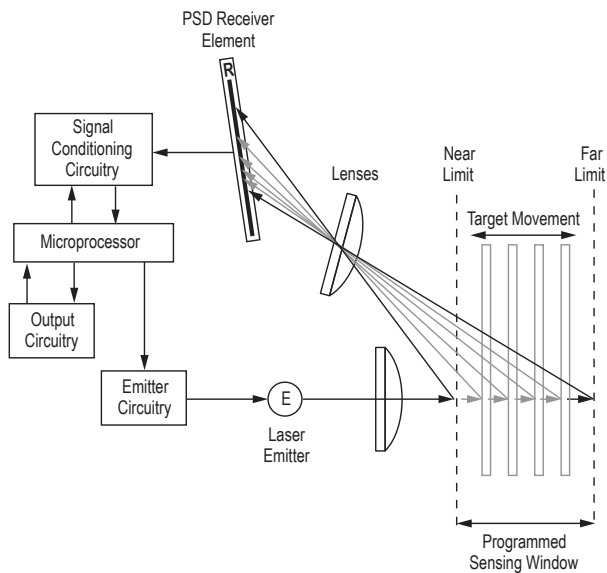

The function of the QS30AF is based on optical triangulation. The emitter circuitry and optics create a light source which is directed toward a target. The light source bounces off the target, scattering some of its light through another lens to the sensor's position-sensitive device (PSD) receiver element. The target's distance from the receiver determines the light's angle to the receiver element. This angle determines where the returned light will fall along the PSD receiver element.

The position of the light on the PSD receiver element is processed through analog and digital electronics and analyzed by the microprocessor, which calculates the appropriate output value.

Figure 2. Using optical triangulation to determine sensing distance

## Sensor Configuration

The sensor's cutoff point is set using a simple procedure, via either the push buttons or the remote wire. Three methods are available: Background Suppression SET, Object Detection SET, and Dynamic SET (remote only). After the sensor has been set for the target application, manual adjustments (via the + and - push buttons) may be used to fine-tune the cutoff point. Sensor output configuration (N.O./N.C.) and the OFF-delay function are also set via the push buttons.

## Remote Configuration

The remote function can be used to configure the sensor remotely or to disable the push button for security. Connect the gray wire of the sensor to ground (0 V dc), with a remote programming switch connected between them. Pulse the remote line according to the diagrams in the configuration procedures. The length of the individual programming pulses is equal to the value T where: 0.04 seconds ≤ "T" ≤ 0.8 seconds

## Background Suppression SET

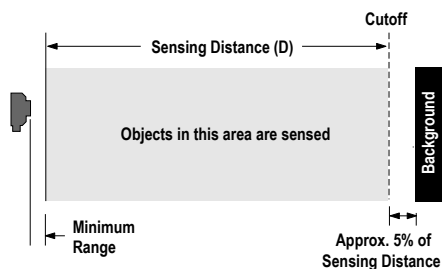
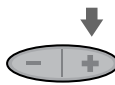

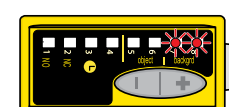
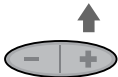

Figure 3. Background Suppression SET

The distance to the background is sampled; the sensor places the cutoff point at approximately 95% of the distance to the background. In RUN mode, objects located between the minimum range and the taught cutoff are sensed; anything beyond the cutoff (for example, other objects or background surfaces) is ignored.

Minimum range varies, depending on the cutoff distance and reflectivity (see [Performance Curves](#) on p. 7).

	Push Button	Remote (0.04 seconds ≤ T ≤ 0.8 seconds)	Result
<b>SET Background</b>	<ol style="list-style-type: none"> <li>1. Present background condition.</li> <li>2. Press and hold <b>Background (+)</b> push button until indicators flash.</li> </ol> 	<ol style="list-style-type: none"> <li>1. Present background condition.</li> <li>2. Single-pulse the remote line.</li> </ol> 	Indicator segments 7 and 8 alternately flash. 

	Push Button	Remote (0.04 seconds ≤ T ≤ 0.8 seconds)	Result
<b>Return to RUN Mode</b>	<p>Sampling continues until the push button is released. The sensor returns to automatically to RUN mode.</p> 	Sensor returns to RUN mode.	<ul style="list-style-type: none"> <li>If cutoff is accepted, sensor returns directly to RUN mode.</li> <li>If cutoff is beyond sensor range, Feedback is displayed for 2 seconds (see <a href="#">Bar Graph Indicator Functions</a> on p. 4).<sup>2</sup></li> </ul>

## Object Detection SET

The distance to the target is sampled; the sensor places the cutoff point at approximately 105% of the distance to the target. In RUN mode, objects located between the minimum range and the cutoff are sensed; anything beyond the cutoff (for example, other objects or background surfaces) is ignored.

Minimum range varies, depending on the cutoff distance and reflectivity (see [Performance Curves](#) on p. 7).

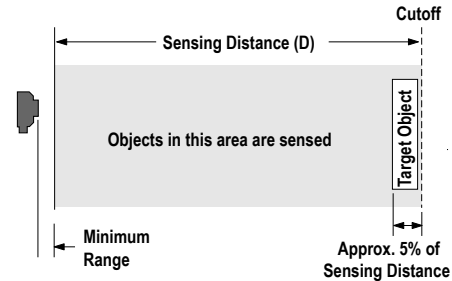
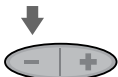
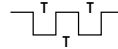
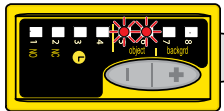
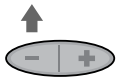

Figure 4. Object Detection SET

	Push Button	Remote (0.04 seconds ≤ T ≤ 0.8 seconds)	Result
<b>Sample Target Object</b>	<ol style="list-style-type: none"> <li>Present target object.</li> <li>Press and hold <b>Object (-)</b> push button until indicators flash.</li> </ol> 	<ol style="list-style-type: none"> <li>Present target object.</li> <li>Double-pulse the remote line.</li> </ol> 	<p>Indicator segments 5 and 6 alternately flash.</p> 
<b>Return to RUN Mode</b>	<p>Sampling continues until the push button is released. The sensor returns automatically to RUN mode.</p> 	Sensor returns automatically to RUN mode.	<ul style="list-style-type: none"> <li><b>Cutoff accepted:</b> Sensor returns directly to RUN mode.</li> <li><b>Cutoff beyond sensor range:</b> Feedback is displayed for 2 seconds (see <a href="#">Bar Graph Indicator Functions</a> on p. 4).<sup>3</sup></li> </ul>

### Manual Adjust

Click the push buttons (+ or -) to adjust the cutoff by approximately 2%.

- To suppress background more, click Background button.
- To increase object detection, click Object button.

The display will momentarily blink to acknowledge cutoff movement. If the cutoff is at an extreme, the far (7th and 8th) or near (1st and 2nd) bar graph segments will flash simultaneously to indicate that the cutoff did not adjust.

<sup>2</sup>

- Segments 7 and 8 simultaneously flashing:** Indiscernible target; sensor defaults to maximum cutoff.
- Segments 1 and 2 simultaneously flashing:** Background is nearer than minimum cutoff; sensor defaults to minimum cutoff.

<sup>3</sup>

- Segments 7 and 8 simultaneously flashing:** Indiscernible target; sensor defaults to maximum cutoff.
- Segments 1 and 2 simultaneously flashing:** Cutoff set is nearer than minimum cutoff; sensor defaults to minimum cutoff.

## Dynamic SET

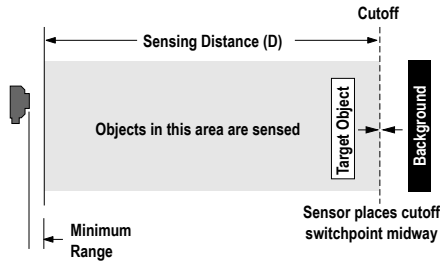

Figure 5. Dynamic SET

The sensor samples the distances to both the target objects and the background surface; the sensor places the cutoff point midway between the object and the background. In RUN mode, objects located between the minimum range and the cutoff are sensed; anything beyond the cutoff (for example, other objects or background surfaces) is ignored. Minimum range varies, depending on the cutoff distance and reflectivity (see [Performance Curves](#) on p. 7).

	Push Button	Remote ( $0.04 \text{ seconds} \leq T \leq 0.8 \text{ seconds}$ )	Result
<b>Sample Target Present and Absent Conditions</b>	Not available via push button.	<ol style="list-style-type: none"> <li>1. Hold remote line low greater than 2 seconds.</li> <li>2. Continue to hold low while presenting at least 1 full application cycle.</li> </ol>	Indicator segments 1 and 8 alternately flash.
<b>Return to RUN Mode</b>		Sampling continues until the remote line is released. The sensor returns automatically to RUN mode.	<ul style="list-style-type: none"> <li>• <b>Cutoff accepted:</b> Sensor returns directly to RUN mode.</li> <li>• <b>Cutoff beyond sensor range:</b> Feedback is displayed for 2 seconds (see <a href="#">Bar Graph Indicator Functions</a> on p. 4).<sup>4</sup></li> </ul>

## Bar Graph Indicator Functions

### RUN Mode

- Lighted bar graph segment represents relative distance from the cutoff point.
- **All segments OFF:** No object is detected within the visible range.

### SET Mode

- **Segments 7 and 8 alternately flashing:** Background Suppression SET is active
- **Segments 5 and 6 alternately flashing:** Object Detection SET is active
- **Segments 1 and 8 alternately flashing:** Dynamic SET is active

### SET Mode Feedback

If the cutoff point is accepted, the sensor returns immediately to RUN mode. If the taught cutoff point is beyond sensor range (closer than 50 mm or farther than 300 mm), the following are indicated for 2 seconds.



**Note:** The sensor defaults to either maximum or minimum cutoff, then returns to RUN mode.

- **Segments 7 and 8 simultaneously flashing:** Indiscernible target; either no target or a highly reflective target (see [Installation Notes](#) on p. 5). Sensor defaults to maximum cutoff.
- **Segments 1 and 2 simultaneously flashing:** Target is nearer than minimum cutoff. Sensor defaults to minimum cutoff.

<sup>4</sup>

- **Segments 7 and 8 simultaneously flashing:** Indiscernible target; sensor defaults to maximum cutoff.
- **Segments 1 and 2 simultaneously flashing:** Cutoff set is nearer than minimum cutoff; sensor defaults to minimum cutoff.

## SETUP Mode

SETUP mode (accessible via push buttons only) is used to change sensor output response for:

- Normally Closed or Normally Open operation
- 30-millisecond pulse stretcher (OFF-delay), if required

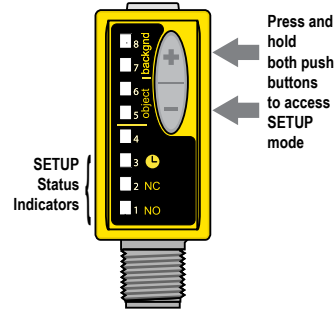

Figure 6. SETUP Mode

The status LEDs, active only during SETUP mode, indicate the output response configuration when the sensor will be in RUN mode. Four combinations are possible:

- Normally Open, No Delay
- Normally Closed, No Delay
- Normally Open, 30 ms Delay
- Normally Closed, 30 ms Delay

### To access SETUP mode and change the output response settings:

1. Press and hold BOTH push buttons simultaneously until the green LED indicator turns OFF.
2. Click EITHER push button to toggle through the four possible setting combinations.
3. Sensor returns to RUN mode after push buttons are inactive for 4 seconds.



**Note:** Outputs are active during SETUP mode.

## Push Button Disable

In addition to its configuration function, the remote wire may be used to disable the push buttons for security. Disabling the push buttons prevents accidental or unauthorized adjustment of the sensor settings. Connect the gray wire of the sensor as described in [Remote Configuration](#) on p. 2, and four-pulse to either enable or disable the push buttons:

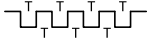

## Wiring Diagrams

Quick disconnect wiring diagrams are functionally identical.

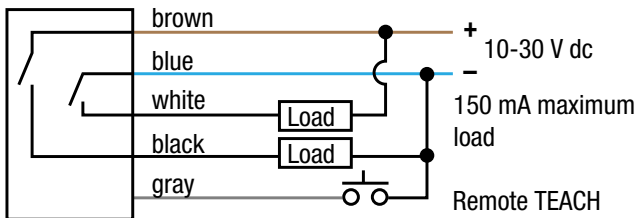

## Installation Notes

Some targets (those with a stepped plane facing the sensor, a boundary line, or rounded targets) pose specific problems for sensing distances. For such applications, see [Figure 7](#) on p. 6 for suggested mounting orientation.

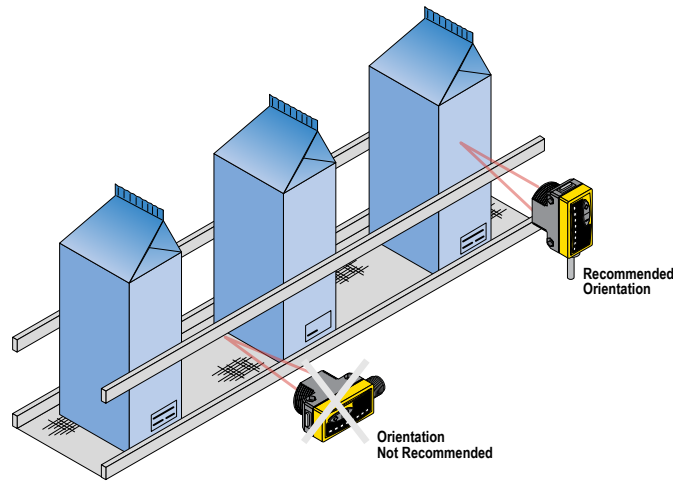

Figure 7. Sensor Orientations for Typical Targets

**Highly Reflective Backgrounds**

Use caution when sensing mirror-like background surfaces that produce specular reflections. False sensor response can occur if a background reflects the sensor's light more strongly to the near end of the detector than to its far end, resulting in a possible false ON condition. Use of a diffusely reflective (matte) background will cure this problem. Other possible solutions are to angle either the sensor or the background (in any plane) so that the background does not reflect back to the sensor (see Figure 8 on p. 6 and Figure 9 on p. 6).

For these applications, the Object Detection SET procedure is recommended.

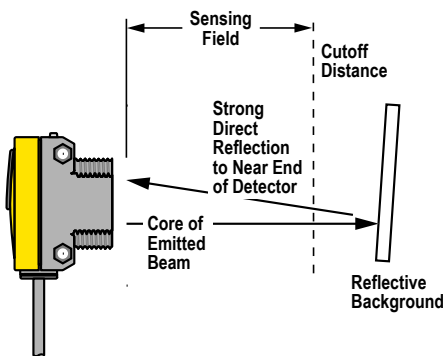

Figure 8. Reflective Background – Problem

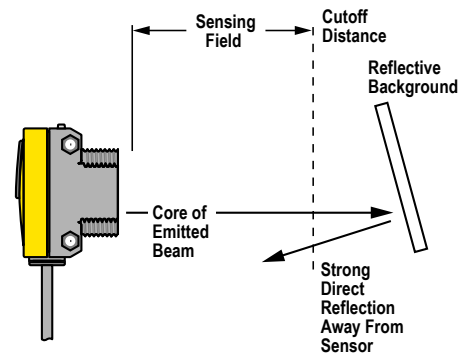

Figure 9. Reflective Background – Solution

**Specifications**

**Sensing Beam**

Visible red, 660 nm

**Supply Voltage**

10 V DC to 30 V DC (10% max. ripple) at less than 45 mA, exclusive of load

**Supply Protection Circuitry**

Protected against reverse polarity, overvoltage, and transient voltages

**Delay at Power-Up**

250 ms; outputs do not conduct at this time

**Output Configuration**

Bipolar: 1 current sourcing (PNP) and 1 current sinking (NPN)

**Output Ratings**

150 mA maximum load (derate ~ 1 mA/°C above 25 °C)

OFF-state leakage current: < 50 µA at 30 V DC

ON-state saturation voltage:

NPN: < 200 mV at 10 mA; < 1 V at 150 mA

PNP: < 1.25 V at 10 mA; < 2 V at 150 mA

**Output Protection**

Protected against output short-circuit, continuous overload, transient over-voltages, and false pulse on power up

**Output Response Time**

1 millisecond

**Repeatability**

170 microseconds

**Certifications**



**Adjustments**

2 push buttons and remote wire

Easy push-button configuration

Manually adjust (+/-) cutoff (push buttons only)

N.O./N.C. and OFF-delay configuration options (push buttons only)

Push-button lockout (from remote wire only)

**Indicators**

8-segment red bar graph: Distance relative to cutoff point

Green LED: Power ON

Yellow LED: Output conducting

**Construction**

ABS plastic housing; acrylic lens cover

**Environmental Rating**

IEC IP67, NEMA 6

**Connections**

5-conductor 2 m (6.5 ft) integral PVC cable, or 9 m (30 ft) integral PVC cable

Integral 5-pin M12/Euro-style male quick disconnect

**Operating Conditions**

-10 °C to +55 °C (+14 °F to +131 °F)

90% at +55 °C maximum relative humidity (non-condensing)

**Vibration and Mechanical Shock**

All models meet MIL-STD-202F, Method 201A (Vibration: 10 Hz to 60 Hz maximum, 0.06 inch (1.52 mm) double amplitude, 10G maximum acceleration) requirements. Also meets IEC 60947-5-2 (Shock: 30G 11 ms duration, half sine wave) requirements.

## Performance Curves

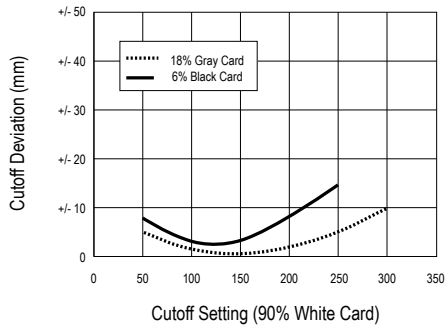

Figure 10. QS30AF Cutoff Point Deviation

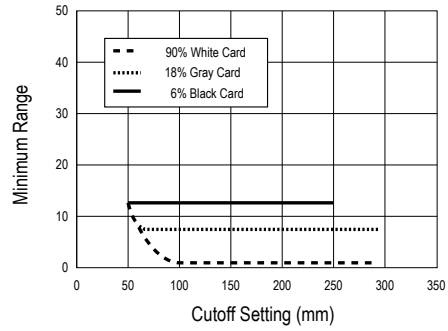

Figure 11. QS30AF Minimum Range vs. Cutoff Setting

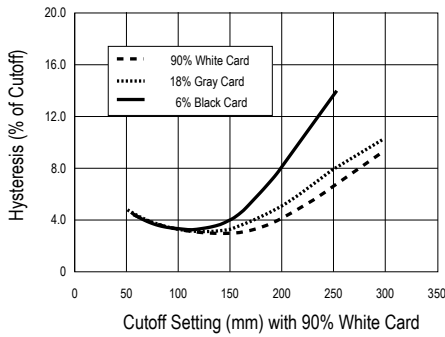
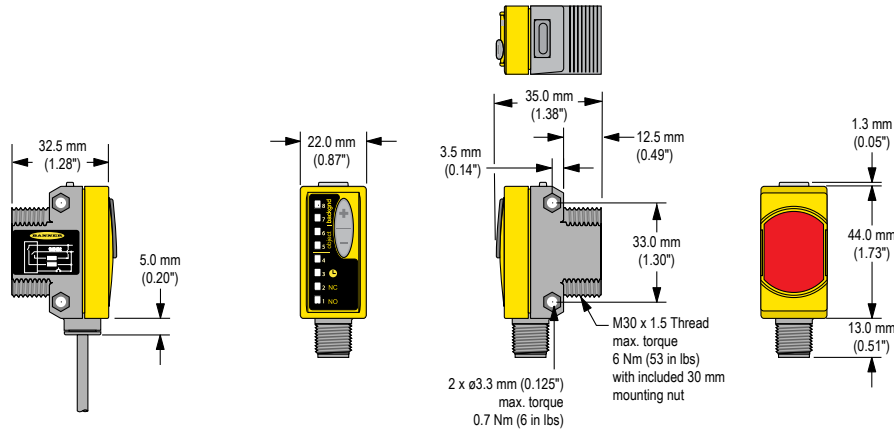

Figure 12. QS30AF Hysteresis

## Dimensions



## Accessories

### Quick-Disconnect (QD) Cordsets

5-Pin Threaded M12/Euro-Style Cordsets—Single Ended				
Model	Length	Style	Dimensions	Pinout (Female)
MQDC1-501.5	0.5 m (1.5 ft)	Straight		
MQDC1-506	2 m (6.5 ft)			
MQDC1-515	5 m (16.4 ft)			
MQDC1-530	9 m (29.5 ft)			

5-Pin Threaded M12/Euro-Style Cordsets—Single Ended				
Model	Length	Style	Dimensions	Pinout (Female)
MQDC1-506RA	2 m (6.5 ft)	Right-Angle		
MQDC1-515RA	5 m (16.4 ft)			
MQDC1-530RA	9 m (29.5 ft)			

## Brackets

### SMBQS30L

- Right-angle bracket for cable sensor models
- Clearance for M4 (#8) hardware
- ± 12° tilt adjustment
- 14-ga. stainless steel



**Hole center spacing:** A to B=35.0  
**Hole size:** A=ø 4.3, B=ø 4.25x16.3

### SMBQS30LT

- Tall right-angle bracket for QD models
- ± 8° tilt adjustment
- 14-ga. stainless steel



**Hole center spacing:** A to B=35.0  
**Hole size:** A=ø 4.3, B=ø 4.25x16.3

### SMBQS30Y

- Heavy-duty die-cast bracket
- M18 vertical mount option
- ± 8° tilt adjustment with cabled units
- Includes nuts and lock washer



**Hole size:** A=ø 15.3

Other Compatible Mounting Brackets (see [www.bannerengineering.com](http://www.bannerengineering.com) for more information):

- SMB30MM
- SMB30SC
- SMB30A

## Banner Engineering Corp Limited Warranty

Banner Engineering Corp. warrants its products to be free from defects in material and workmanship for one year following the date of shipment. Banner Engineering Corp. will repair or replace, free of charge, any product of its manufacture which, at the time it is returned to the factory, is found to have been defective during the warranty period. This warranty does not cover damage or liability for misuse, abuse, or the improper application or installation of the Banner product.

**THIS LIMITED WARRANTY IS EXCLUSIVE AND IN LIEU OF ALL OTHER WARRANTIES WHETHER EXPRESS OR IMPLIED (INCLUDING, WITHOUT LIMITATION, ANY WARRANTY OF MERCHANTABILITY OR FITNESS FOR A PARTICULAR PURPOSE), AND WHETHER ARISING UNDER COURSE OF PERFORMANCE, COURSE OF DEALING OR TRADE USAGE.**

This Warranty is exclusive and limited to repair or, at the discretion of Banner Engineering Corp., replacement. **IN NO EVENT SHALL BANNER ENGINEERING CORP. BE LIABLE TO BUYER OR ANY OTHER PERSON OR ENTITY FOR ANY EXTRA COSTS, EXPENSES, LOSSES, LOSS OF PROFITS, OR ANY INCIDENTAL, CONSEQUENTIAL OR SPECIAL DAMAGES RESULTING FROM ANY PRODUCT DEFECT OR FROM THE USE OR INABILITY TO USE THE PRODUCT, WHETHER ARISING IN CONTRACT OR WARRANTY, STATUTE, TORT, STRICT LIABILITY, NEGLIGENCE, OR OTHERWISE.**

Banner Engineering Corp. reserves the right to change, modify or improve the design of the product without assuming any obligations or liabilities relating to any product previously manufactured by Banner Engineering Corp. Any misuse, abuse, or improper application or installation of this product or use of the product for personal protection applications when the product is identified as not intended for such purposes will void the product warranty. Any modifications to this product without prior express approval by Banner Engineering Corp will void the product warranties. All specifications published in this document are subject to change; Banner reserves the right to modify product specifications or update documentation at any time. Specifications and product information in English supersede that which is provided in any other language. For the most recent version of any documentation, refer to: [www.bannerengineering.com](http://www.bannerengineering.com).

For patent information, see [www.bannerengineering.com/patents](http://www.bannerengineering.com/patents).