

| | | | | | | | | | | | | | | | | | | | | | | | | | | | | | | | |
|----------|----|----|----|----|----|----|----|----|----|----|----|----|----|----|----|----|----|----|----|----|----|----|----|----|----|----|----|----|----|----|----|
| GEN. ST. | 01 | 02 | 03 | 04 | 05 | 06 | 07 | 08 | 0D | 50 | 60 | 70 | 80 | 90 | | | | | | | | | | | | | | | | | |
| INT. ST. | 10 | 11 | 12 | 13 | 14 | 18 | 20 | 31 | 32 | 33 | 34 | 38 | 39 | 40 | 42 | 43 | 44 | 45 | 46 | 48 | 56 | 70 | 72 | 73 | 75 | 76 | 81 | 82 | 83 | 84 | 88 |

| REV. | DATE | DESCRIPTION | BY | C'K'D' |
|------|------------|------------------------|--------|--------|
| A | 2001-09-14 | CONVERSION REVISION 02 | KN | |
| B | 2002-05-28 | EC B20086 | MF | |
| C | 2005-11-04 | 105-0212 | ALEX B | BKP |
| D | 2006-07-05 | 106-0096 | VIVEK | BKP |

LOADING PATTERN MATING SIDE

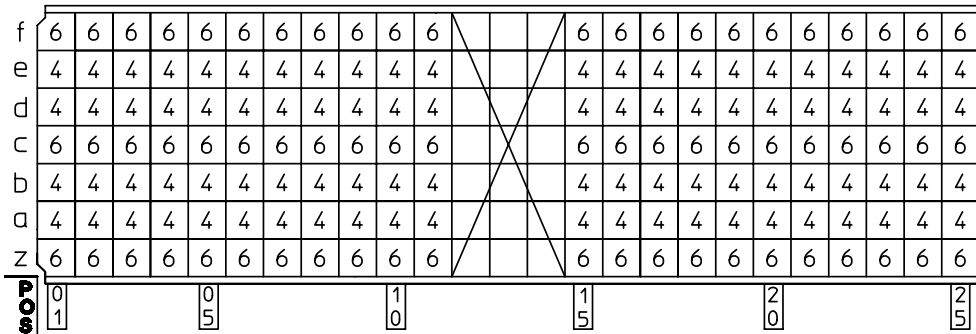

LOADED CONNECTOR ASSEMBLY (FOR EXAMPLE)

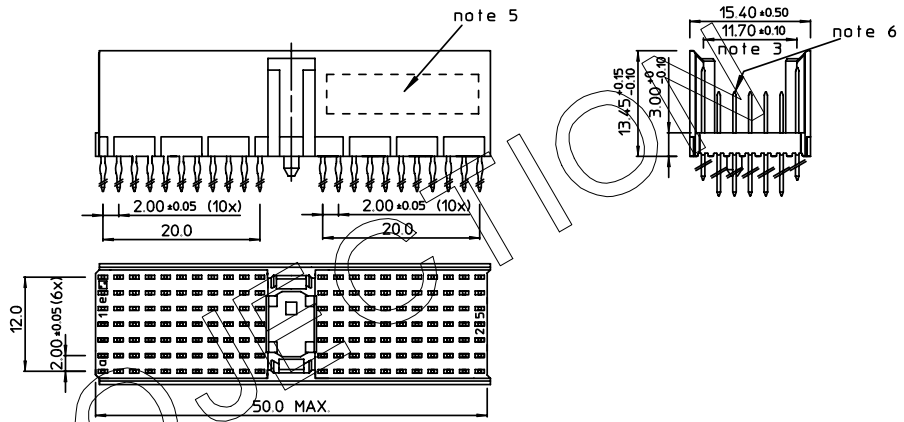

SHEET NR. : 551

CONTACT OVERVIEW

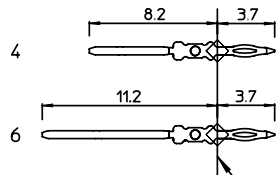

SEATING PLANE FOR CONNECTOR

LAY-OUT P.C.B.-HOLE

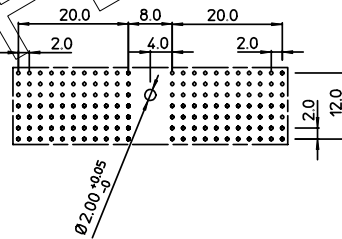

LEAD FREE INDICATOR : LF = LEAD FREE (DIGIT 15 & 16)



HM2P07PD5151

PLATING CODE (DIGIT 13 AND 14) (REF DWG No. BS,C ,201844,003)

NOTES:

- THIS PRODUCT IS CSA APPROVED.
- THIS PRODUCT IS UL RECOGNIZED.
- MEASURED AT THE BOTTOM.
- MATERIAL CONTACT: PHOSPHORBRONZE
HOUSING: CREAM WHITE GLASSFILLED POLYESTER UL-94V0
- CONNECTOR PRINTED WITH P/N AND DATE CODE.
- FOR ACTUAL CONTACT LOADINGS, SEE LOADING PATTERN MATING SIDE.
- SHAPE OF CONNECTOR HOUSING CAN ALTER DEPENDING ON PRODUCTION LOCATION.
- THE PRODUCT (LF) MEETS EUROPEAN UNION DIRECTIVES AND OTHER COUNTRY REGULATIONS AS DESCRIBED IN GS-22-008
- FOR RECOMMENDED PTH DIMENSIONS REFER DRAWING : BS,A ,201572,001

EUROPEAN PRO

| | | | | |
|---|---------------|------------|--------|--|
| 1DEC ±0.2 2DEC ±0.1 ANGLES ±1° | APPR. | DATE | SIGN. | LOADING PATTERN OVERVIEW |
| | DRAFT | 1998-02-05 | M.Fret | CAT. No. HM2P07PD5151---- |
| WE RESERVE THE RIGHT TO CHANGE DIMENSIONS OR REQUIREMENTS WITHOUT PRIOR NOTICE. | CHECKED | | |  www.fciconnect.com |
| | PROD. MGR. | | | |
| | PR. ENG. MGR. | | | |
| ALL DIMENSIONS IN MM | PR. MGT. MGR. | | | SCALE |
| REFERENCES | | | | |
|   | | | | BS,C ,201843,116 D DRAWING No. CUSTOMER DRAWING REVISION |

THIS IS OUR EXCLUSIVE PROPERTY. IT IS NOT TO BE COPIED, REPRINTED OR DISCLOSED TO A THIRD PARTY, NOR USED FOR MANUFACTURING WITHOUT OUR WRITTEN CONSENT, AND HAS TO BE RETURNED TO US IN CASE OF NO USAGE

DIT IS ONZE EIGENDOM EN MAG NIET NAGEMAAKT, HERDRUKT, OVERGEHAAKT AAN DEREN OF TOEGELIJK GEMAKT WORDEN, ZONDER ONZE SCHRIFTELIJKE TOELATING. BIJ NIET GEBRUIK IS TERUGZENDING VERPLICHT.