

LOC	DIST	REVISIONS REVISIONI			
P	LTR REV	DESCRIPTION DESCRIZIONE	DATE DATA	DWN DIS.	APVD APP.
	A	FIRST ISSUE EC ET00-0065-99 (WAS 96-51009)	FEB99	A.M.	O.C.
	AI	RELEASED FOR PRODUCTION	ET00 0201-99	07 Sept 99	G. S. O.C.

SECTION A-A
(SEZIONE A-A)

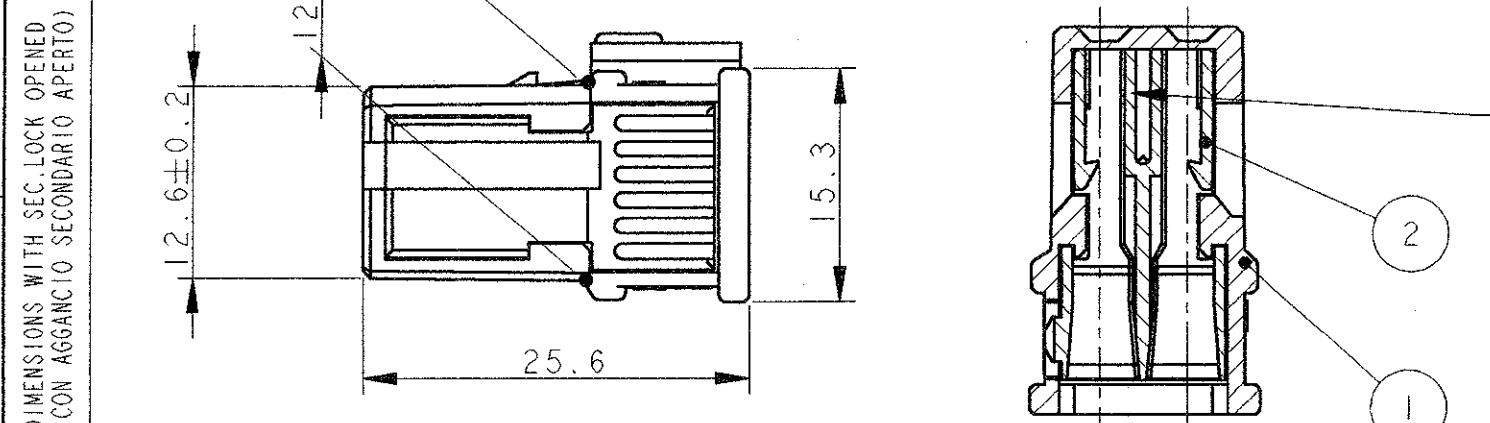

SUPPLIED WITH SEC. LOCKING DEVICE ON PRE-ASSEMBLED POSITION (FORNITO CON IL DISPOSITIVO DI AGGANCIAMENTO SECONDARIO IN POS. PRE-ASSEMBLATO)

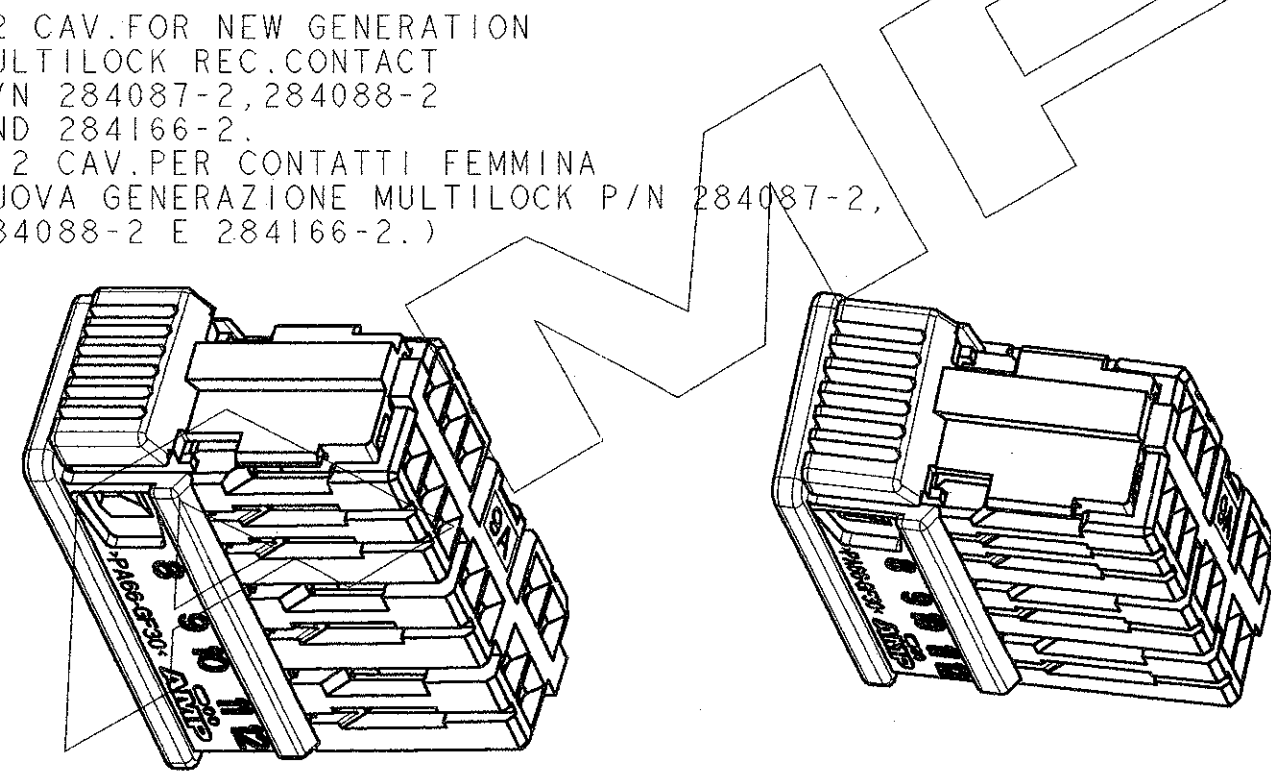
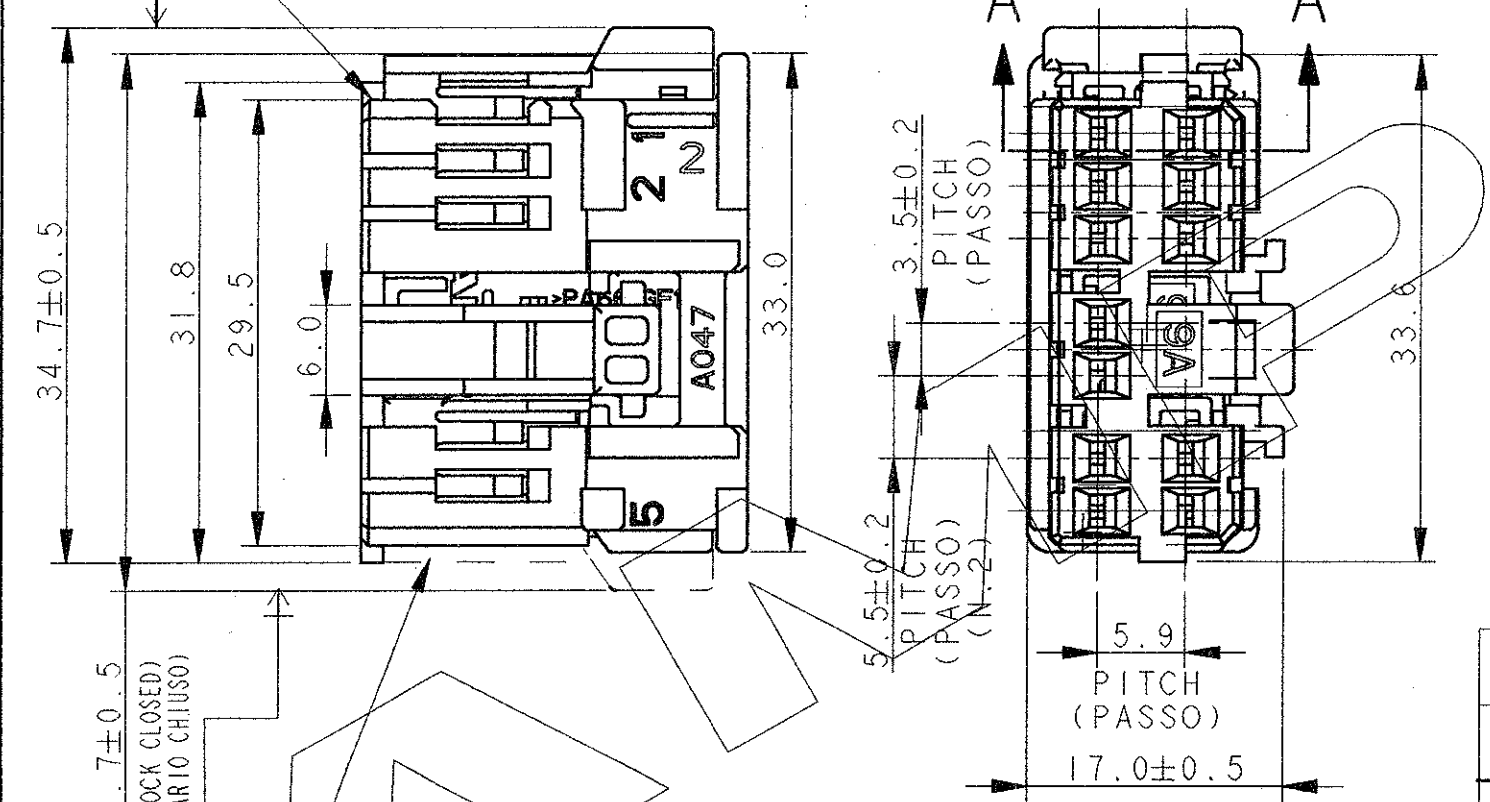

282990-2 AS SHOWN (COME MOSTRATO)

ITEM	DESCRIPTION (DESCRIZIONE)	FINISH/COLOUR (FINITURA/COLORE)	MATERIAL (MATERIALE)	PART NUMBER (NUMERO)
2	RECEPTACLE HOUSING (BLOCC. PORTA FEMMINE)	SEE SHEET 2 VED. FOGLIO 2	PA 66 G.F.	SEE SHEET 2 VED. FOGLIO 2
1	SEC. LOCKING DEVICE (AGGANCIAMENTO SECONDARIO)	SEE SHEET 2 VED. FOGLIO 2	PA 66 G.F.	SEE SHEET 2 VED. FOGLIO 2

<p>THIS DRAWING IS A CONTROLLED DOCUMENT FOR AMP INCORPORATED. IT IS SUBJECT TO CHANGE AND THE CONTROLLING ENGINEERING ORGANIZATION SHOULD BE CONTACTED FOR THE LATEST REVISION. QUESTO DISEGNO E' UN DOCUMENTO DI PROPRIETA' E RESPONSABILITA' DELL'AMP ITALIA S.P.A. SOGGETTO A VARIAZIONI. PER OTTENERE L'ULTIMA REVISIONE DEL DISEGNO CONTATTARE AMP ITALIA S.P.A.</p>		<p>DWN / DIS. 4-MAR-99 ANDREA MARANGON CHK / CONT. 4-MAR-99 OSCAR CANUTO APVD / APP. 4-MAR-99 ALESSANDRO GENTA</p>		<p>AMP AMP ITALIA SpA. C.so Filii Cervi 15 COLLEGNO (TO)</p>	
<p>DIMENSIONS: DIMENSIONI: mm</p>		<p>TOLERANCES UNLESS OTHERWISE SPECIFIED: TOLLERANZE: SE NON DIVERSAMENTE SPECIFICATO</p> <p>0 PLC / DEC ± 0.3 1 PLC / DEC ± 0.3 2 PLC / DEC ± 3 PLC / DEC ± 4 PLC / DEC ± ANGLES / ANGOLI ± 2</p>		<p>NAME: NAME 12 POS. NEW GENERATION RECEPTACLE CONNECTOR for trucks</p>	
<p>MATERIAL: MATERIALE SEE TABLE (VEDI TABELLA)</p>		<p>FINISH: FINITURA -</p>		<p>PRODUCT SPEC: SPEC. DI PRODOTTO 108-20175 APPLICATION SPEC: SPEC. DI APPLICAZIONE 114-20098</p>	
<p>WEIGHT: PESO 5.5 g</p>		<p>SIZE: A3 CAGE CODE: 00779</p>		<p>DRAWING NO. NUMERO: 282990</p>	
<p>CUSTOMER DRAWING: DISEGNO PER CLIENTE FOR REFERENCE ONLY: SOLO PER RIFERIMENTO</p>		<p>SCALE: 2:1 SHEET: 1 OF 2</p>		<p>REV: AI</p>	

LOC	DIST	REVISIONS REVISIONI		
		P	LTR REV	DESCRIPTION DESCRIZIONE
				DATE DATA
				DWN DIS.
				APVD APP.
SEE SHEET 1, (VEDERE FOGLIO 1)				

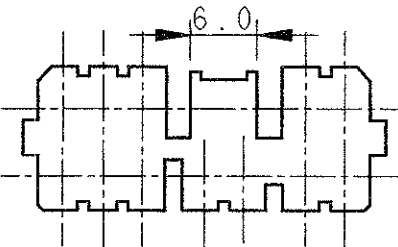
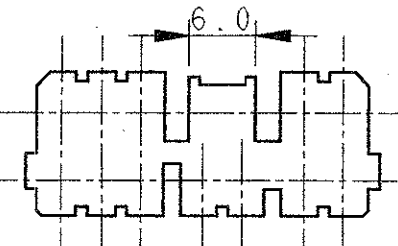
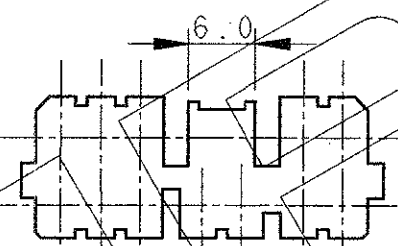
P/N	ITEM 1 COLOUR (COLORE)	GRAPHIC REPRESENTATION MATING FACE (RAPPRESENTAZIONE GRAFICA LATO ACCOPPIAMENTO)	P/N FREE HANGING COUNTERPART (CONTROPARTE VOLANTE)	P/N APPLICATION PANEL (DIMA DI APPLICAZIONE)
282990-2	BLACK (NERO)		282993-2	92-51126-2
282990-3	BLUE (BLU)		282993-3	92-51126-3
282990-4	GREY (GRIGIO)		282993-4	92-51126-4

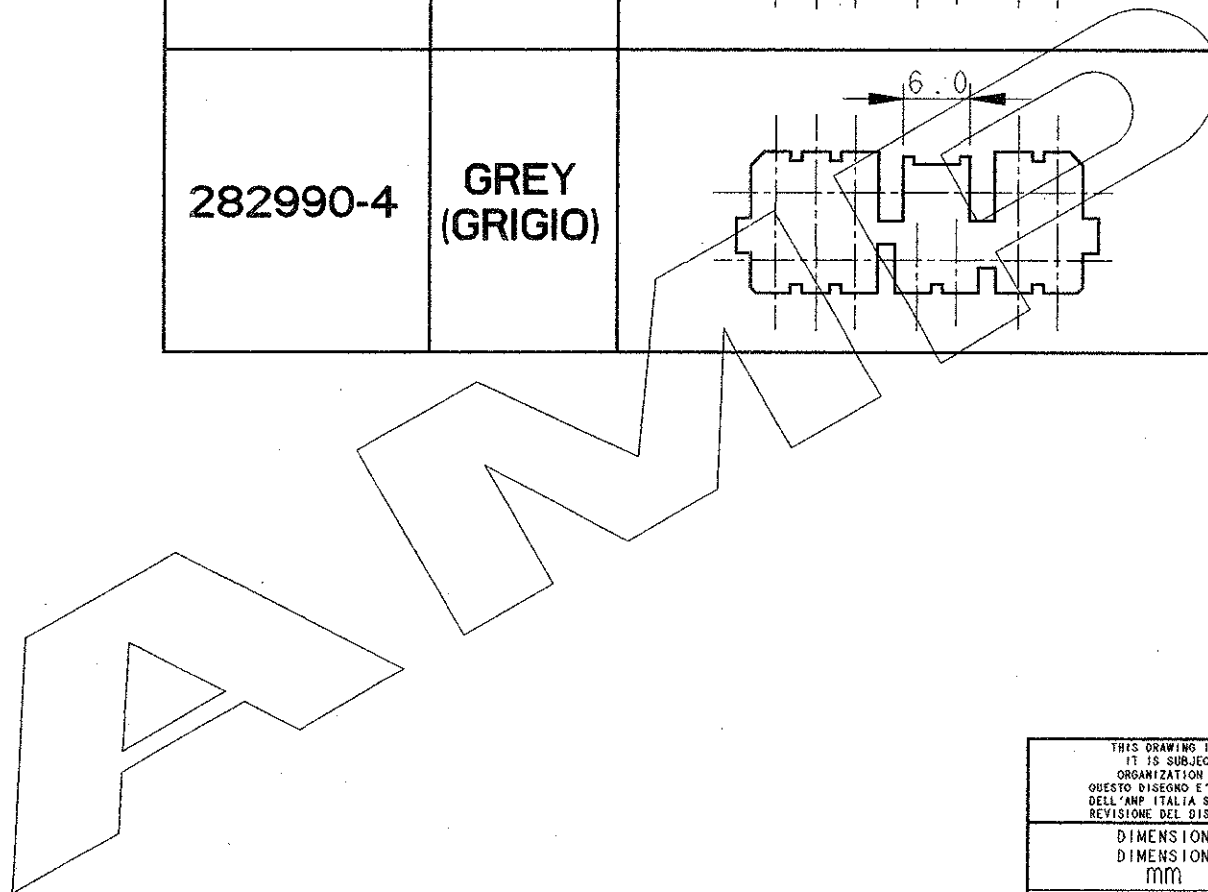

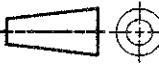
<small>THIS DRAWING IS A CONTROLLED DOCUMENT FOR AMP INCORPORATED. IT IS SUBJECT TO CHANGE AND THE CONTROLLING ENGINEERING ORGANIZATION SHOULD BE CONTACTED FOR THE LATEST REVISION. QUESTO DISEGNO E' UN DOCUMENTO DI PROPRIETA' E RESPONSABILITA' DELL'AMP ITALIA S.p.A. SOGGETTO A VARIAZIONI. PER OTTENERE L'ULTIMA REVISIONE DEL DISEGNO CONTATTARE AMP ITALIA S.p.A.</small>		DWN / DIS. 4-MAR-99 ANDREA MARANGON CHK / CONT. 4-MAR-99 OSCARE CANUTO APVD / APP. 4-MAR-99 ALESSANDRO GENTA	AMP AMP ITALIA Sp.A. C.so Filii Cervi 15 COLLEGNO (TO)
DIMENSIONS: DIMENSIONI: mm	TOLERANCES UNLESS OTHERWISE SPECIFIED: TOLLERANZE, SE NON DIVERSAMENTE SPECIFICATO 0 PLC / DEC ±0.3 1 PLC / DEC ±0.3 2 PLC / DEC ± 3 PLC / DEC ± 4 PLC / DEC ± ANGLES / ANGOLI ±2	NAME NONE SIZE A3	12 POS. NEW GENERATION RECEPTACLE CONNECTOR for trucks
	MATERIAL MATERIALE SEE SHEET 1 (VEDERE FOGLIO 1)	APPLICATION SPEC SPEC DI PRODOTTO SEE SHEET 1 (VEDERE FOGLIO 1) APPLICATION SPEC SPEC DI APPLICAZIONE SEE SHEET 1 (VEDERE FOGLIO 1)	CAGE CODE 00779 DRAWING NO NUMERO 282990
CUSTOMER DRAWING DISEGNO PER CLIENTE FOR REFERENCE ONLY. SOLO PER RIFERIMENTO		WEIGHT PESO SEE SHEET 1 (VEDERE FOGLIO 1)	SCALE SCALA SHEET FOGLIO 2 OF 2 REV A1