

| REVISIONS |     |                            |         |     |      |
|-----------|-----|----------------------------|---------|-----|------|
| REV       | ECO | DESCRIPTION                | DATE    | BY  | APPR |
| A3        | -   | RELEASE NEW DRAWING FORMAT | 11DEC13 | DRP | -    |

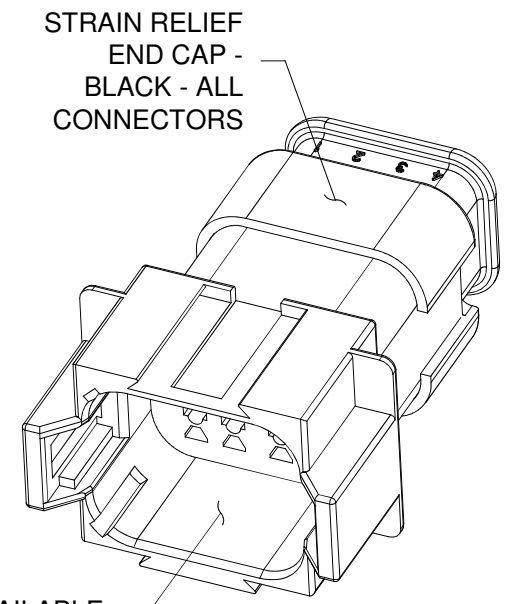
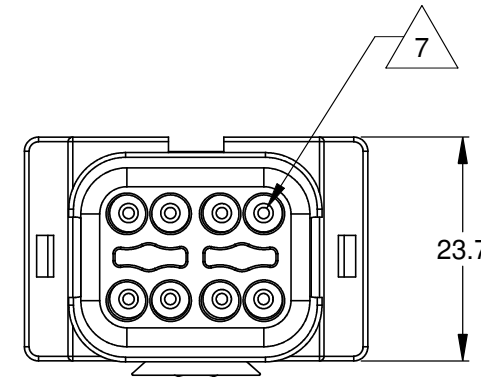
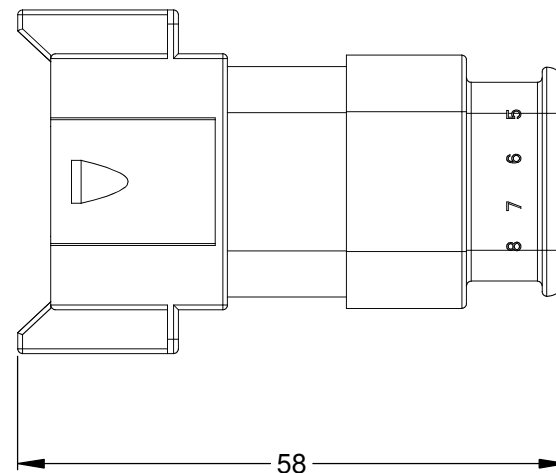
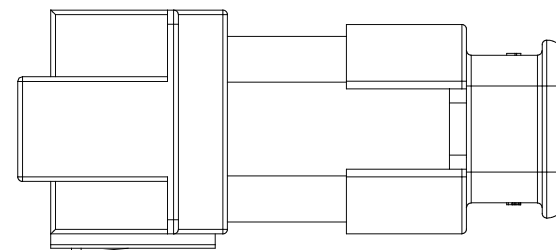
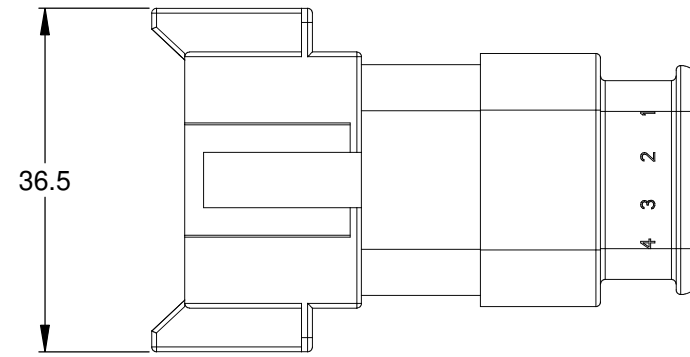

REQUIRES CONTACT RETENTION WEDGE AW8P

1 KEYWAY (2) PLACES

STRAIN RELIEF END CAP - BLACK - ALL CONNECTORS

1 REFER TO SHEET 2 FOR AVAILABLE CONNECTOR HOUSING COLORS

NOTES: UNLESS OTHERWISE SPECIFIED

1 SEE SHEET 2 FOR KEY ARRANGEMENTS AND COLORS.

2. MATERIAL:  
HOUSING: THERMOPLASTIC  
SEAL: SILICONE RUBBER

3. MODIFICATIONS: STRAIN RELIEF END CAP

4. SPECIFICATIONS:  
4.1 CURRENT RATING: 13 AMPS  
4.2 OPERATING TEMPERATURE: -55°C TO +125°C  
4.3 DIELECTRIC WITHSTANDING VOLTAGE: LESS THAN 2 MILLIAMPS CURRENT LEAKAGE @ 1500 VOLTS AC.  
4.4 INSULATION RESISTANCE: 1000 MEGOHMS MIN @ 25°C.  
4.5 MOISTURE RESISTANCE: IP67 ( MATED CONDITION )  
4.6 MATING CYCLE DURABILITY: 100 CYCLES  
4.7 RoHS COMPLIANT

5. MATING PART: AT06-08SX\* PLUG  
( X = A,B,C,D KEYS; \* = MODIFICATIONS AND COLORS )

6. ALL DIMENSIONS ARE FOR REFERENCE USE ONLY.

7 CONTACT SIZE AND REAR SEAL WIRE RANGE:

| CONTACT SIZE | MIN. INSUL O.D.   | MAX. INSUL O.D.   | TYPICAL WIRE RANGE |
|--------------|-------------------|-------------------|--------------------|
| 16           | 2.24 mm (.088 in) | 3.68 mm (.145 in) | 14 - 20 AWG        |

| QUANTITY   | SEE SHEET 2 PART NUMBER | DESCRIPTION   | ITEM  |
|--|-------------------------|---|---|
| <b>MATERIALS LIST</b>  |                         |   |   |
| UNLESS OTHERWISE SPECIFIED<br>1) All dimensions are in metric (mm).<br>2) Tolerances are as follows:<br>1 PL DEC ±0.30<br>2 PL DEC ±0.15<br>3 PL DEC ±0.08<br>Fractions ±1/64<br>Angles ±1°<br>3) Note reference = X |                         | SIGNATURES<br>DRAWN: D.PARKS<br>CHECKED:<br>ENGINEER:<br>APPROVAL:  | DATE<br>11DEC13                                       |
| MATERIAL SPECIFICATIONS:   |                         | <p style="text-align: center;"><b>Amphenol</b></p> <p style="text-align: center;">Sine Systems - www.amphenol-sine.com<br/>44724 Morley Drive<br/>Clinton Township, MI 48036</p> <p style="text-align: center;"><b>RECEPTACLE, 8 PIN, AT SERIES, KEYED, STRAIN RELIEF END CAP</b></p> |   |
| PROCESS SPECIFICATIONS:  |                         |   |   |
| NEXT ASSY:   | CUSTOMER:               | THIS DRAWING IS SUPPLIED FOR INFORMATION ONLY. DESIGN FEATURES, SPECIFICATIONS AND PERFORMANCE DATA SHOWN HEREON ARE THE PROPERTY OF THE AMPHENOL CORPORATION. NO RIGHTS OF REPRODUCTION ARE IMPLIED. ALL DIMENSIONS ARE SUBJECT TO NORMAL MANUFACTURING VARIATIONS.                  | REVISION  |
|  |                         | SIZE: <b>B C-</b><br>SCALE: NONE  | DWG NO: <b>AT04-08PX-SRXXX</b><br>REVISION: <b>A3</b> |
|  |                         | SHEET 1 OF 2  |   |

TITLE: RECEPTACLE, 8 PIN, AT SERIES, KEYED, STRAIN RELIEF END CAP  
DWG NO: AT04-08PX-SRXXX  
REV: A3  
SH: 1  
OF: 2

| REVISIONS |     |             |      |    |      |
|-----------|-----|-------------|------|----|------|
| REV       | ECO | DESCRIPTION | DATE | BY | APPR |

P/N AT04-08PA-SRGRY  
KEY-A CONFIGURATION  
STANDARD COLOR: GREY

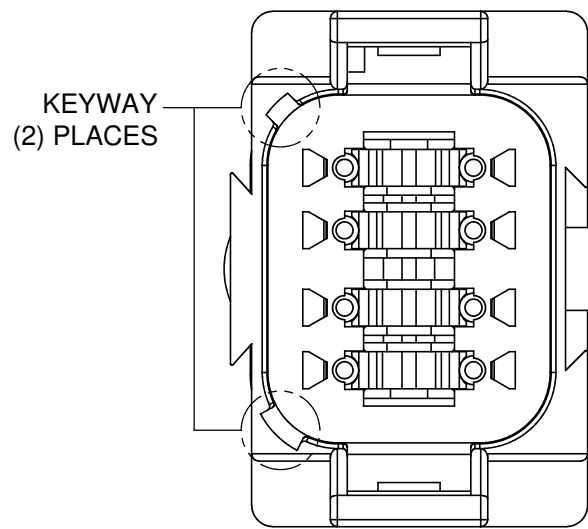

P/N AT04-08PB-SRBK  
KEY-B CONFIGURATION  
STANDARD COLOR: BLACK

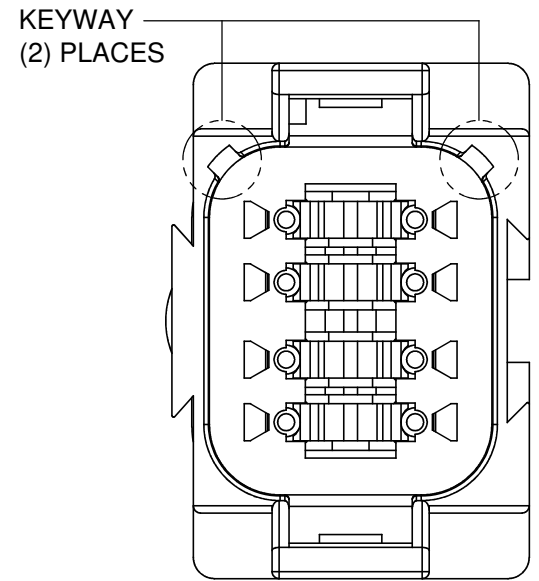

P/N AT04-08PC-SRGN  
KEY-C CONFIGURATION  
STANDARD COLOR: GREEN

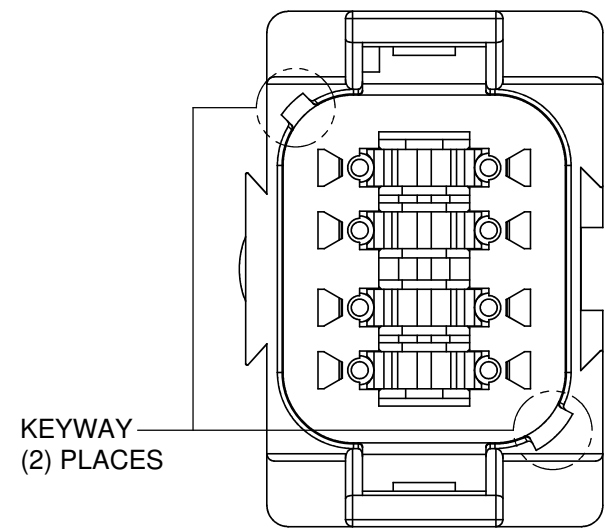

P/N AT04-08PD-SRBR  
KEY-D CONFIGURATION  
STANDARD COLOR: BROWN

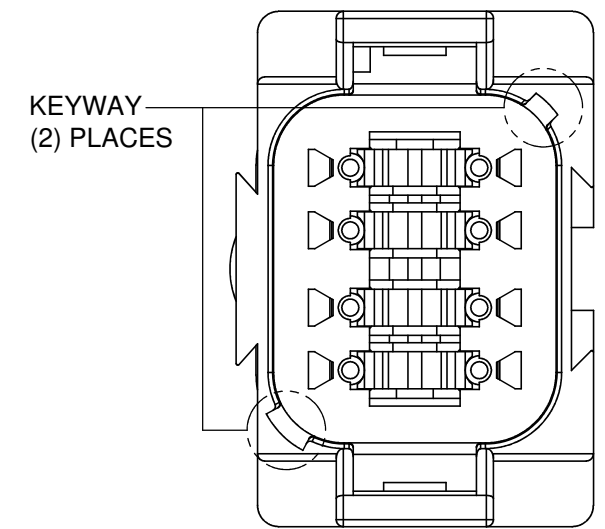

| KEY-A CONFIGURATION |                        |
|---------------------|------------------------|
| COLOR               | PART NUMBER            |
| <b>* GREY</b>       | <b>AT04-08PA-SRGRY</b> |
| BLACK               | AT04-08PA-SRBK         |
| GREEN               | AT04-08PA-SRGN         |
| BROWN               | AT04-08PA-SRBR         |

| KEY-B CONFIGURATION |                       |
|---------------------|-----------------------|
| COLOR               | PART NUMBER           |
| GREY                | AT04-08PB-SRGRY       |
| <b>* BLACK</b>      | <b>AT04-08PB-SRBK</b> |
| GREEN               | AT04-08PB-SRGN        |
| BROWN               | AT04-08PB-SRBR        |

| KEY-C CONFIGURATION |                       |
|---------------------|-----------------------|
| COLOR               | PART NUMBER           |
| GREY                | AT04-08PC-SRGRY       |
| BLACK               | AT04-08PC-SRBK        |
| <b>* GREEN</b>      | <b>AT04-08PC-SRGN</b> |
| BROWN               | AT04-08PC-SRBR        |

| KEY-D CONFIGURATION |                       |
|---------------------|-----------------------|
| COLOR               | PART NUMBER           |
| GREY                | AT04-08PD-SRGRY       |
| BLACK               | AT04-08PD-SRBK        |
| GREEN               | AT04-08PD-SRGN        |
| <b>* BROWN</b>      | <b>AT04-08PD-SRBR</b> |

NOTE:

AN ASTERISKS ( \* ) PLACED BEFORE THE COLOR DENOTES THE STANDARD MOLDED COLOR OF THE CONNECTORS SHOWN ABOVE. STRAIN RELIEF END CAPS ARE AVAILABLE IN BLACK ONLY.



OTHER COLORS SHOWN ARE AVAILABLE VIA SPECIAL ORDER.



TITLE: RECEPTACLE, 8 PIN, AT SERIES, KEYED, STRAIN RELIEF END CAP  
DWG NO.: AT04-08PX-SRXXX  
REV: A3  
SH: 2  
OF: 2

| QUANTITY   | PART NUMBER | DESCRIPTION  | ITEM      |            |         |          |          |           |                        |           |  |           |  |           |  |
|--|-------------|--|-----------|------------|---------|----------|----------|-----------|------------------------|-----------|--|-----------|--|-----------|--|
| <b>MATERIALS LIST</b>  |             |  |           |            |         |          |          |           |                        |           |  |           |  |           |  |
| UNLESS OTHERWISE SPECIFIED<br>1) All dimensions are in metric (mm).<br>2) Tolerances are as follows:<br>1 PL DEC ±0.30<br>2 PL DEC ±0.15<br>3 PL DEC ±0.08<br>Fractions ±1/64<br>Angles ±1°<br>3) Note reference =   |             | <table border="1"> <thead> <tr> <th>SIGNATURES</th> <th>DATE</th> </tr> </thead> <tbody> <tr> <td>D.PARKS</td> <td>11DEC13</td> </tr> <tr> <td>CHECKED:</td> <td></td> </tr> <tr> <td>ENGINEER:</td> <td></td> </tr> <tr> <td>APPROVAL:</td> <td></td> </tr> <tr> <td>CUSTOMER:</td> <td></td> </tr> </tbody> </table> |           | SIGNATURES | DATE    | D.PARKS  | 11DEC13  | CHECKED:  |                        | ENGINEER: |  | APPROVAL: |  | CUSTOMER: |  |
| SIGNATURES   | DATE        |  |           |            |         |          |          |           |                        |           |  |           |  |           |  |
| D.PARKS  | 11DEC13     |  |           |            |         |          |          |           |                        |           |  |           |  |           |  |
| CHECKED:   |             |  |           |            |         |          |          |           |                        |           |  |           |  |           |  |
| ENGINEER:  |             |  |           |            |         |          |          |           |                        |           |  |           |  |           |  |
| APPROVAL:  |             |  |           |            |         |          |          |           |                        |           |  |           |  |           |  |
| CUSTOMER:  |             |  |           |            |         |          |          |           |                        |           |  |           |  |           |  |
| MATERIAL SPECIFICATIONS:   |             | <h1>Amphenol</h1> <p>Sine Systems - www.amphenol-sine.com<br/>44724 Morley Drive<br/>Clinton Township, MI 48036</p> <p>RECEPTACLE, 8 PIN, AT SERIES,<br/>KEYED, STRAIN RELIEF END CAP</p>  |           |            |         |          |          |           |                        |           |  |           |  |           |  |
| PROCESS SPECIFICATIONS:  |             |  |           |            |         |          |          |           |                        |           |  |           |  |           |  |
| NEXT ASSY:   |             |  |           |            |         |          |          |           |                        |           |  |           |  |           |  |
| THIS DRAWING IS SUPPLIED FOR INFORMATION ONLY. DESIGN FEATURES, SPECIFICATIONS AND PERFORMANCE DATA SHOWN HEREON ARE THE PROPERTY OF THE AMPHENOL CORPORATION. NO RIGHTS OF REPRODUCTION ARE IMPLIED. ALL DIMENSIONS ARE SUBJECT TO NORMAL MANUFACTURING VARIATIONS. |             | <table border="1"> <tr> <td>SIZE</td> <td>TYPE</td> <td>DWG NO.</td> <td>REVISION</td> </tr> <tr> <td><b>B</b></td> <td><b>C-</b></td> <td><b>AT04-08PX-SRXXX</b></td> <td><b>A3</b></td> </tr> </table>   | SIZE      | TYPE       | DWG NO. | REVISION | <b>B</b> | <b>C-</b> | <b>AT04-08PX-SRXXX</b> | <b>A3</b> |  |           |  |           |  |
| SIZE   | TYPE        | DWG NO.  | REVISION  |            |         |          |          |           |                        |           |  |           |  |           |  |
| <b>B</b>   | <b>C-</b>   | <b>AT04-08PX-SRXXX</b>   | <b>A3</b> |            |         |          |          |           |                        |           |  |           |  |           |  |
| SCALE: NONE  |             | SHEET 2 OF 2   |           |            |         |          |          |           |                        |           |  |           |  |           |  |



# AT Series™ - Contact Size 16 Options

| Machined Contacts, Sockets & Pins |  |      |       |          |
|-----------------------------------|--|------|-------|----------|
| Part Number                       | Description                            | Size | AWG   | Type     |
| AT60-215-1631                     | Male Contact - Pin, Gold-plated        | 16   | 14    | Machined |
| AT62-209-1631                     | Female Contact - Socket, Gold-plated   | 16   | 14    | Machined |
| AT60-215-16141                    | Male Contact - Pin, Nickel-plated      | 16   | 14    | Machined |
| AT62-209-16141                    | Female Contact - Socket, Nickel-plated | 16   | 14    | Machined |
| AT60-202-1631                     | Male Contact - Pin, Gold-plated        | 16   | 16-20 | Machined |
| AT62-201-1631                     | Female Contact - Socket, Gold-plated   | 16   | 16-20 | Machined |
| AT60-202-16141                    | Male Contact - Pin, Nickel-plated      | 16   | 16-20 | Machined |
| AT62-201-16141                    | Female Contact - Socket, Nickel-plated | 16   | 16-20 | Machined |
| AT60-202-1631-22                  | Male Contact - Pin, Gold-plated        | 16   | 22-24 | Machined |
| AT62-201-1631-22                  | Female Contact - Socket, Gold-plated   | 16   | 22-24 | Machined |
| AT60-202-16141-22                 | Male Contact - Pin, Nickel-plated      | 16   | 22-24 | Machined |
| AT62-201-16141-22                 | Female Contact - Socket, Nickel-plated | 16   | 22-24 | Machined |

| Tooling - Machined Contacts   |             |   |
|---|-------------|---|
| Part  | Part Number | Description   |
|  | CA-5D12     | Universal Hand Crimp Tool, Size 12/16/20 (Machined contacts only) |
|  | CA-5E12     | Pneumatic Crimp Tool, Size 12/16/20 (Machined contacts only)      |

| Contact Removal Tools   |               |   |
|---|---------------|---|
| Part  | Part Number   | Description   |
|  | ATRT-100      | Used for removal of contacts for A Series™ products |
|  | AT11-310-1605 | Contact Removal Tool, Plastic, Size 16              |
|  | A114017       | Sealing Plug, Size 16, White                        |

| Stamped & Formed Contacts, Sockets & Pins |  |      |       |                  |
|---|--|------|-------|------------------|
| Part Number                               | Description                            | Size | AWG   | Type             |
| AT60-14-0144                              | Male Contact - Pin, Gold-plated        | 16   | 14-16 | Stamped & Formed |
| AT62-14-0144                              | Female Contact - Socket, Gold-plated   | 16   | 14-16 | Stamped & Formed |
| AT60-14-0122                              | Male Contact - Pin, Nickel-plated      | 16   | 14-16 | Stamped & Formed |
| AT62-14-0122                              | Female Contact - Socket, Nickel-plated | 16   | 14-16 | Stamped & Formed |
| AT60-16-0144                              | Male Contact - Pin, Gold-plated        | 16   | 16-18 | Stamped & Formed |
| AT62-16-0144                              | Female Contact - Socket, Gold-plated   | 16   | 16-18 | Stamped & Formed |
| AT60-16-0122                              | Male Contact - Pin, Nickel-plated      | 16   | 16-18 | Stamped & Formed |
| AT62-16-0122                              | Female Contact - Socket, Nickel-plated | 16   | 16-18 | Stamped & Formed |
| AT60-16-0644                              | Male Contact - Pin, Gold-plated        | 16   | 18-20 | Stamped & Formed |
| AT62-16-0644                              | Female Contact - Socket, Gold-plated   | 16   | 18-20 | Stamped & Formed |
| AT60-16-0622                              | Male Contact - Pin, Nickel-plated      | 16   | 18-20 | Stamped & Formed |
| AT62-16-0622                              | Female Contact - Socket, Nickel-plated | 16   | 18-20 | Stamped & Formed |
| AT60-16-0844                              | Male Contact - Pin, Gold-plated        | 16   | 20-22 | Stamped & Formed |
| AT62-16-0844                              | Female Contact - Socket, Gold-plated   | 16   | 20-22 | Stamped & Formed |
| AT60-16-0822                              | Male Contact - Pin, Nickel-plated      | 16   | 20-22 | Stamped & Formed |
| AT62-16-0822                              | Female Contact - Socket, Nickel-plated | 16   | 20-22 | Stamped & Formed |

| Tooling - Stamped & Formed Contacts   |             |   |
|---|-------------|---|
| Part  | Part Number | Description   |
|   | MFX-3950    | Crimp Die - Size 16, 18-20AWG (S&F contacts only)       |
|   | MFX-3953    | Crimp Die - Size 16, 16-18AWG (S&F contacts only)       |
|   | MFX-3975    | Crimp Die - Size 16, 14-16AWG (S&F contacts only)       |
|   | MFX-3990    | Crimp Die - Size 16, 20-22AWG (S&F contacts only)       |
|  | ATT-16-00   | Hand Crimp Tool - Size 16, 14-16AWG (S&F contacts only) |
|   | ATT-16-01   | Hand Crimp Tool - Size 16, 18-20AWG (S&F contacts only) |
|   | ATT-1612-03 | Hand Crimp Tool - Size 16, 20-22AWG (S&F contacts only) |

**Amphenol Sine Systems**  
 44724 Morley Drive  
 Clinton Township, MI 48036 USA  
[www.amphenol-sine.com](http://www.amphenol-sine.com)  
 09/2021