

PNP Silicon Digital Transistor

- Switching circuit, inverter, interface circuit, driver circuit
- Built in bias resistor ($R_1 = 22k\Omega$, $R_2 = 47k\Omega$)
- For 6-PIN packages: two (galvanic) internal isolated transistors with good matching in one package

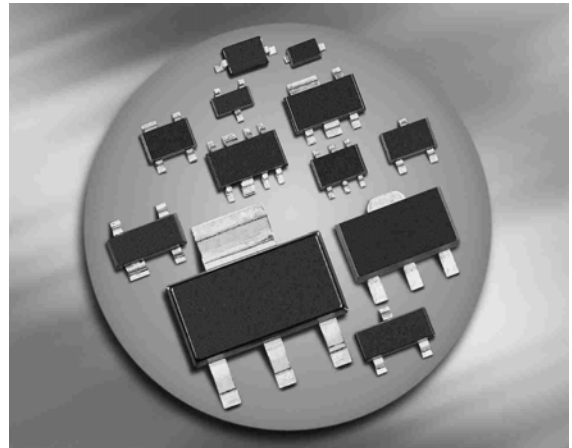

**BCR192/F/L3
BCR192T/W**

BCR192U

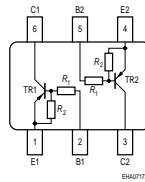
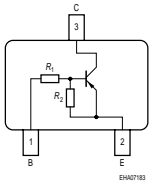

Type	Marking	Pin Configuration						Package
		1=B	2=E	3=C	-	-	-	
BCR192	WPs	1=B	2=E	3=C	-	-	-	SOT23
BCR192F	WPs	1=B	2=E	3=C	-	-	-	TSFP-3
BCR192L3	WP	1=B	2=E	3=C	-	-	-	TSLP-3-4
BCR192T	WPs	1=B	2=E	3=C	-	-	-	SC75
BCR192U	WPs	1=E1	2=B1	3=C2	4=E2	5=B2	6=C1	SC74
BCR192W	WPs	1=B	2=E	3=C	-	-	-	SOT323

Maximum Ratings

Parameter	Symbol	Value	Unit
Collector-emitter voltage	V_{CEO}	50	V
Collector-base voltage	V_{CBO}	50	
Emitter-base voltage	V_{EBO}	50	
Input on voltage	$V_{i(on)}$	30	
Collector current	I_C	100	mA
Total power dissipation- BCR192, $T_S \leq 102^\circ\text{C}$ BCR192F, $T_S \leq 128^\circ\text{C}$ BCR192L3, $T_S \leq 135^\circ\text{C}$ BCR192T, $T_S \leq 109^\circ\text{C}$ BCR192U, $T_S \leq 118^\circ\text{C}$ BCR192W, $T_S \leq 124^\circ\text{C}$	P_{tot}	200 250 250 250 250 250	mW
Junction temperature	T_j	150	$^\circ\text{C}$
Storage temperature	T_{stg}	150 ... -65	

Thermal Resistance

Parameter	Symbol	Value	Unit
Junction - soldering point ¹⁾	R_{thJS}		K/W
BCR192		≤ 240	
BCR192F		≤ 90	
BCR192L3		≤ 60	
BCR192T		≤ 165	
BCR192U		≤ 133	
BCR192W		≤ 105	

¹⁾For calculation of R_{thJA} please refer to Application Note Thermal Resistance

Electrical Characteristics at $T_A = 25^\circ\text{C}$, unless otherwise specified

Parameter	Symbol	Values			Unit
		min.	typ.	max.	
DC Characteristics					
Collector-emitter breakdown voltage $I_C = 100 \mu\text{A}, I_B = 0$	$V_{(BR)CEO}$	50	-	-	V
Collector-base breakdown voltage $I_C = 10 \mu\text{A}, I_E = 0$	$V_{(BR)CBO}$	50	-	-	
Collector-base cutoff current $V_{CB} = 40 \text{ V}, I_E = 0$	I_{CBO}	-	-	100	nA
Emitter-base cutoff current $V_{EB} = 10 \text{ V}, I_C = 0$	I_{EBO}	-	-	227	μA
DC current gain ¹⁾ $I_C = 5 \text{ mA}, V_{CE} = 5 \text{ V}$	h_{FE}	70	-	-	-
Collector-emitter saturation voltage ¹⁾ $I_C = 10 \text{ mA}, I_B = 0,5 \text{ mA}$	V_{CEsat}	-	-	0,3	V
Input off voltage $I_C = 100 \mu\text{A}, V_{CE} = 5 \text{ V}$	$V_{i(off)}$	0,5	-	1,2	
Input on voltage $I_C = 2 \text{ mA}, V_{CE} = 0,3 \text{ V}$	$V_{i(on)}$	0,8	-	2,5	
Input resistor	R_1	15	22	29	$\text{k}\Omega$
Resistor ratio	R_1/R_2	0,42	0,47	0,52	-
AC Characteristics					
Transition frequency $I_C = 10 \text{ mA}, V_{CE} = 5 \text{ V}, f = 100 \text{ MHz}$	f_T	-	200	-	MHz
Collector-base capacitance $V_{CB} = 10 \text{ V}, f = 1 \text{ MHz}$	C_{cb}	-	3	-	pF

¹Pulse test: $t < 300 \mu\text{s}$; $D < 2\%$

DC current gain $h_{FE} = f(I_C)$

$V_{CE} = 5\text{ V}$ (common emitter configuration)

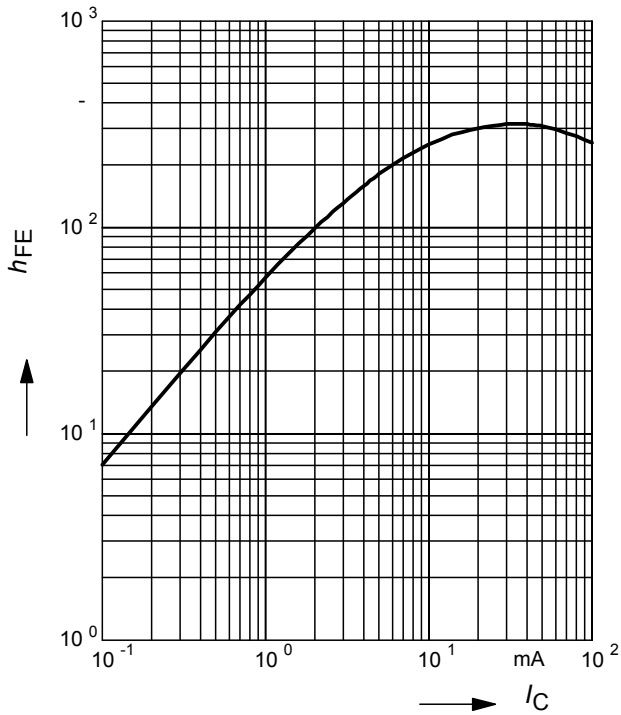

Collector-emitter saturation voltage

$V_{CEsat} = f(I_C), h_{FE} = 20$

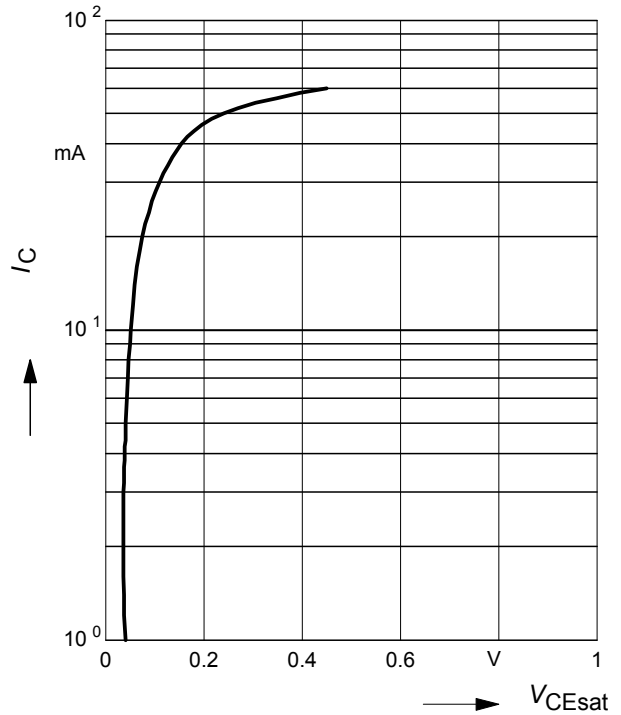

Input on Voltage $V_{i(on)} = f(I_C)$

$V_{CE} = 0.3\text{ V}$ (common emitter configuration)

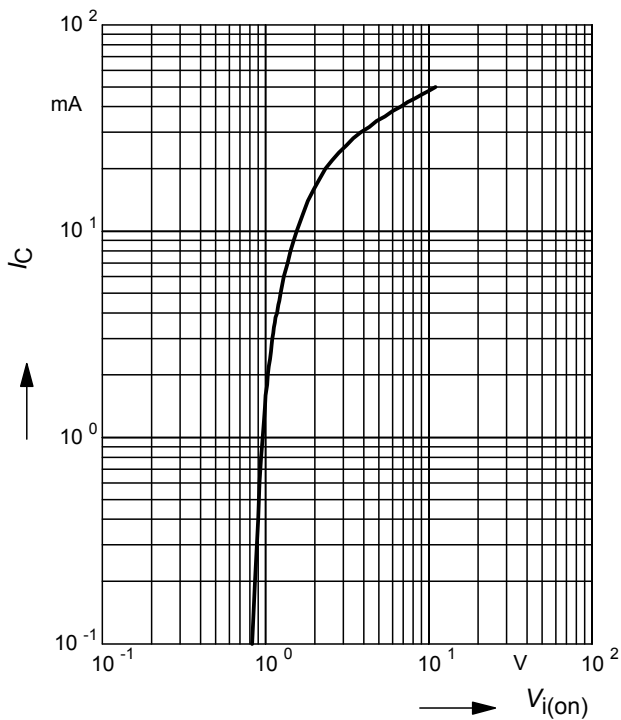

Input off voltage $V_{i(off)} = f(I_C)$

$V_{CE} = 5\text{ V}$ (common emitter configuration)

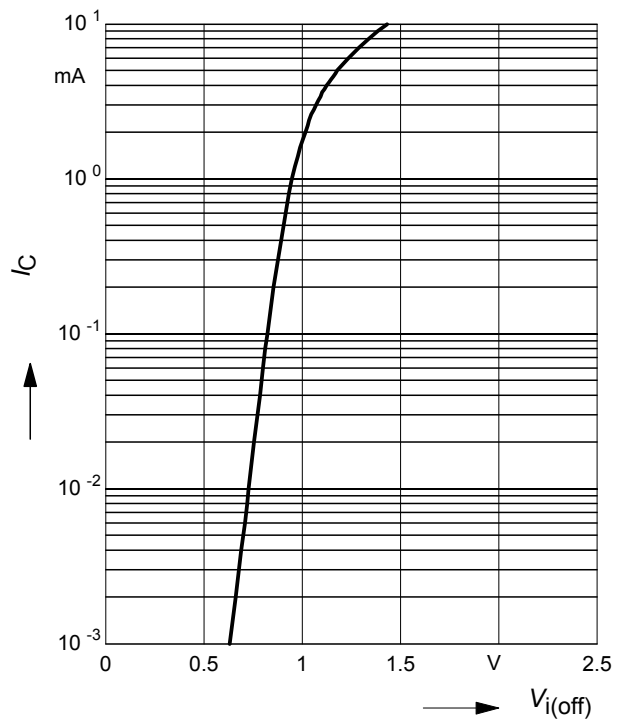

Total power dissipation $P_{tot} = f(T_S)$

BCR192

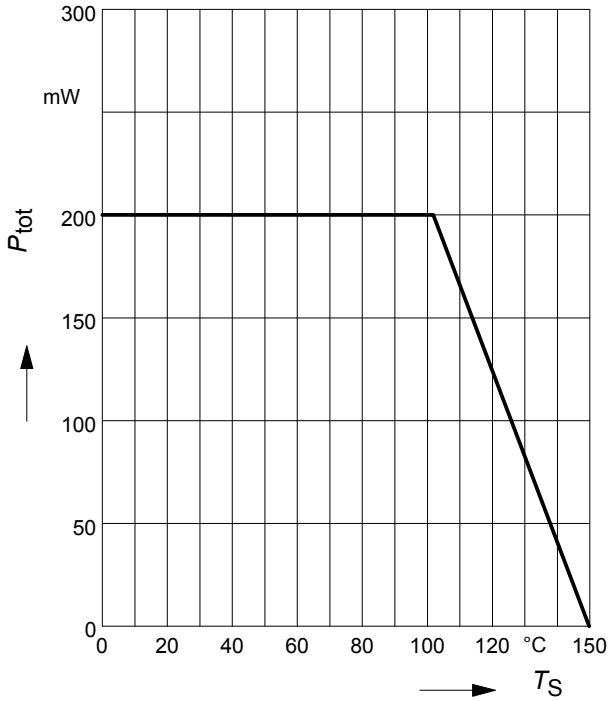

Total power dissipation $P_{tot} = f(T_S)$

BCR192F

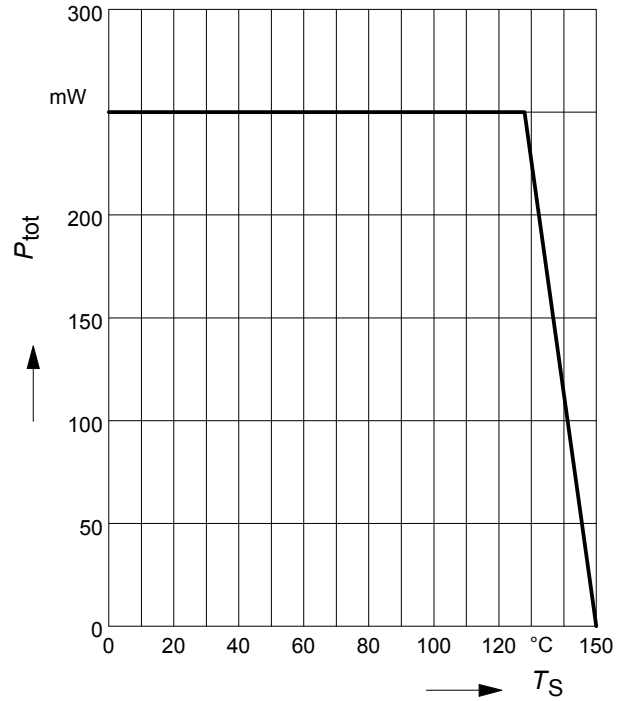

Total power dissipation $P_{tot} = f(T_S)$

BCR192L3

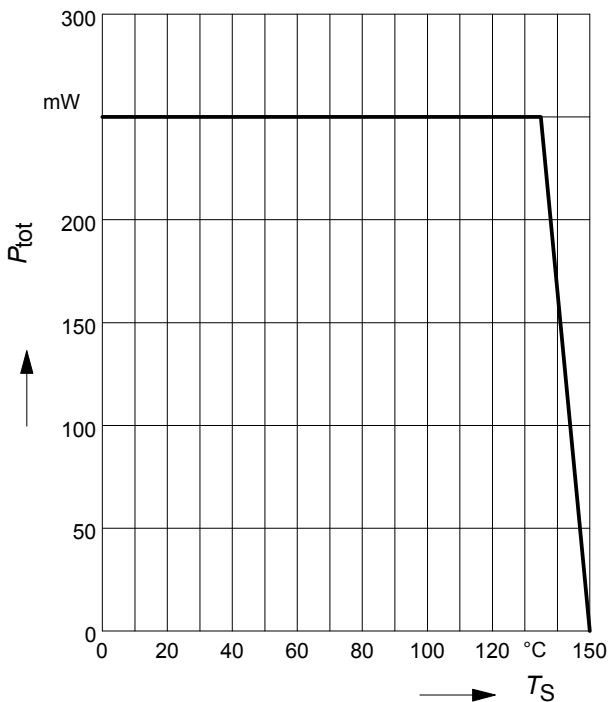

Total power dissipation $P_{tot} = f(T_S)$

BCR192T

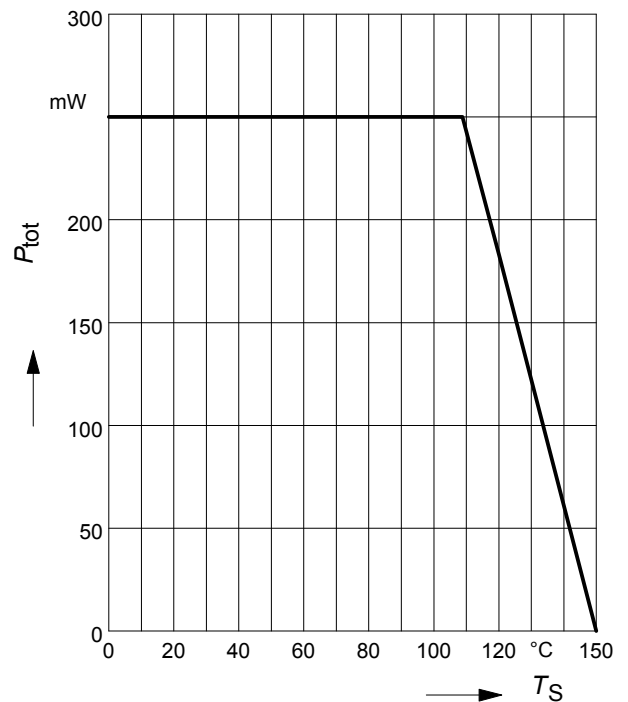

Total power dissipation $P_{tot} = f(T_S)$

BCR192U

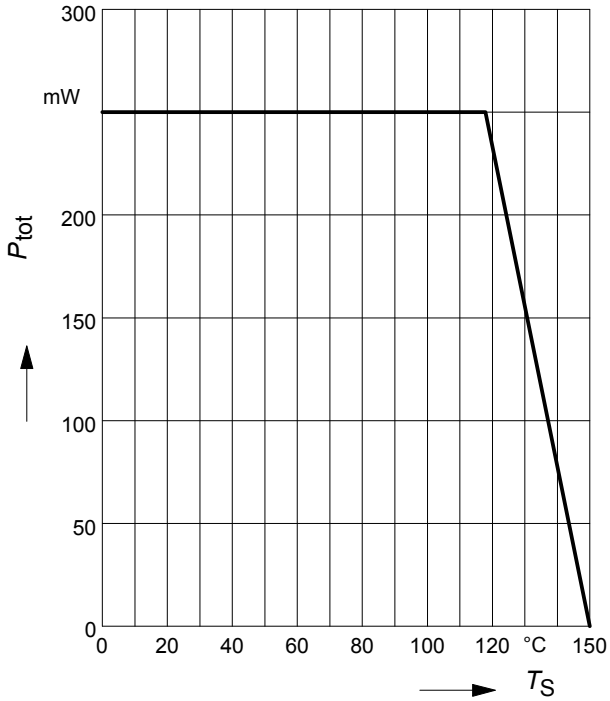

Total power dissipation $P_{tot} = f(T_S)$

BCR192W

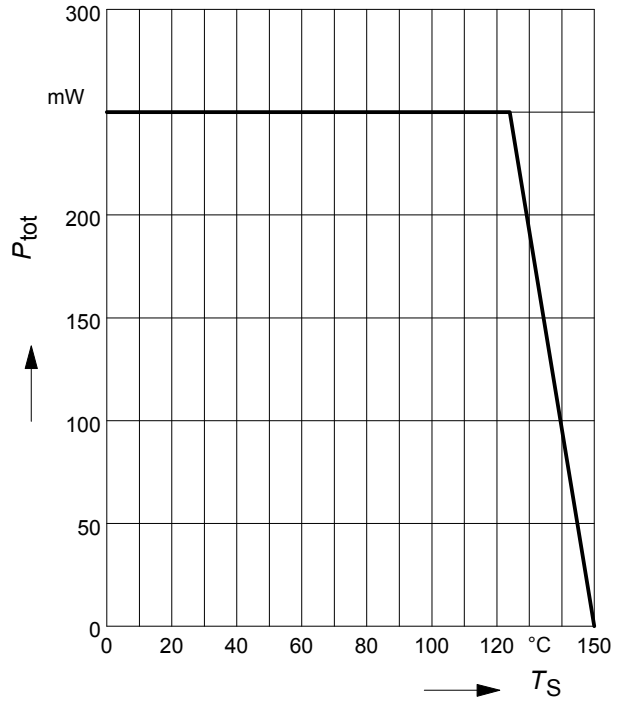

Permissible Pulse Load $R_{thJS} = f(t_p)$

BCR192

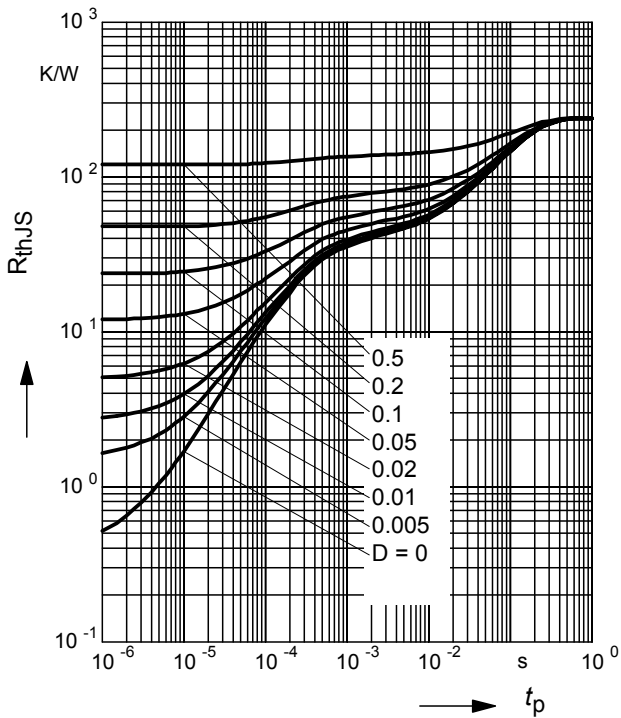

Permissible Pulse Load

$P_{totmax}/P_{totDC} = f(t_p)$

BCR192

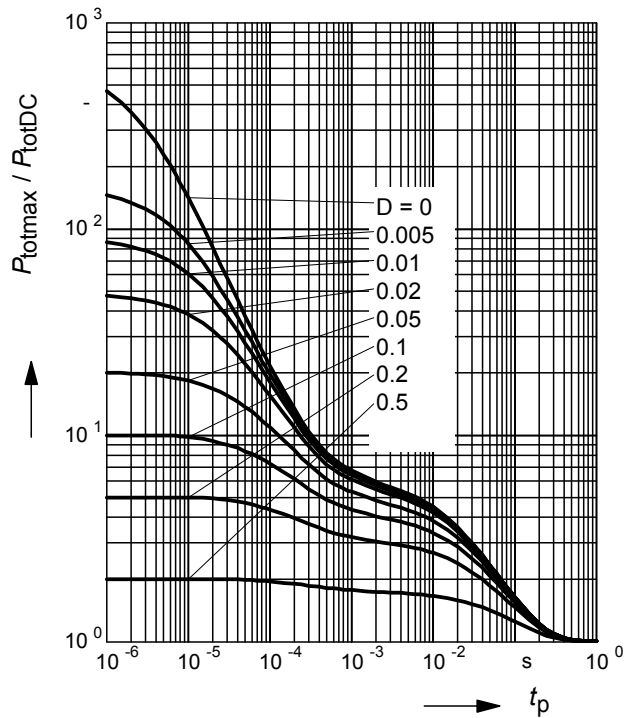

Permissible Puls Load $R_{thJS} = f(t_p)$

BCR192F

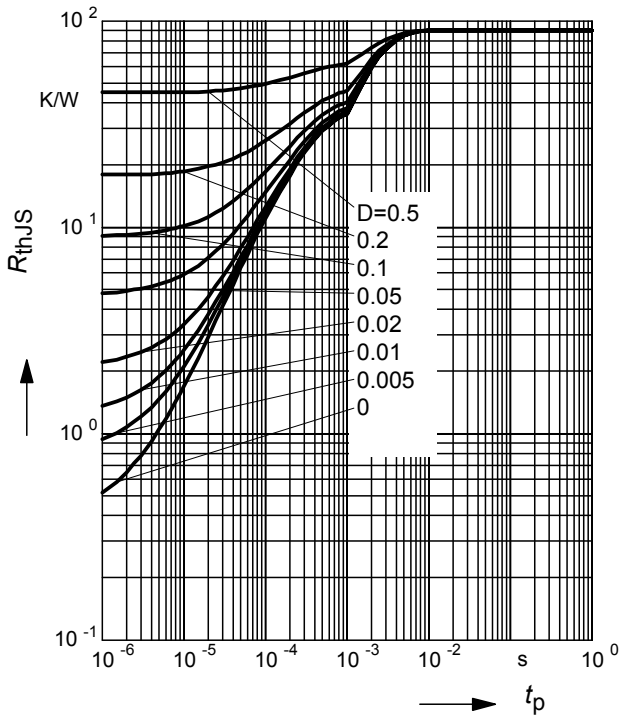

Permissible Pulse Load

$P_{totmax}/P_{totDC} = f(t_p)$

BCR192F

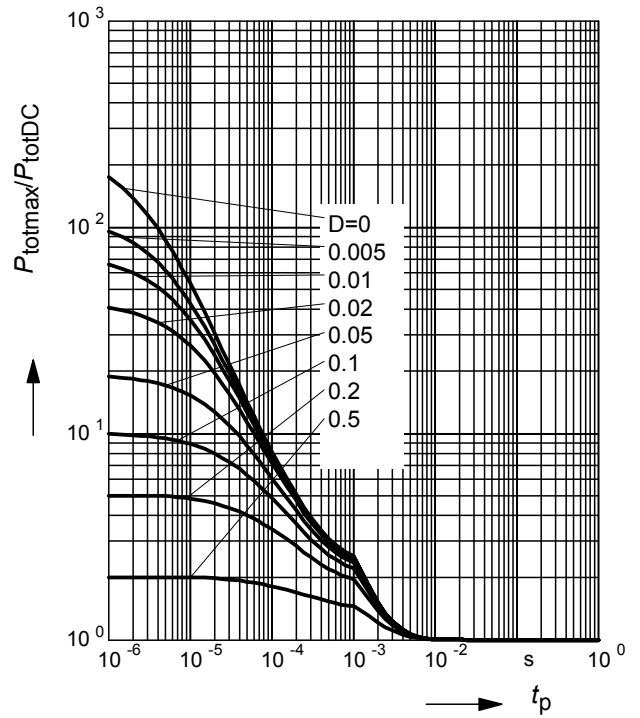

Permissible Puls Load $R_{thJS} = f(t_p)$

BCR192L3

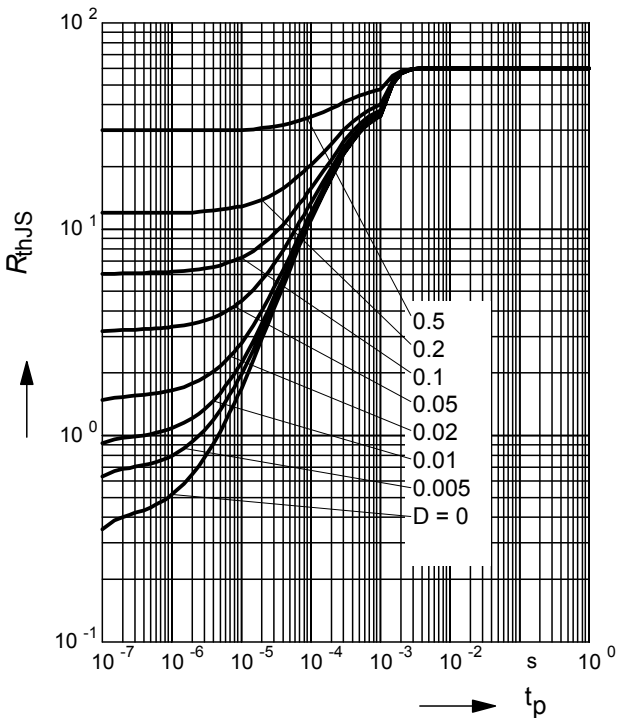

Permissible Pulse Load

$P_{totmax}/P_{totDC} = f(t_p)$

BCR192L3

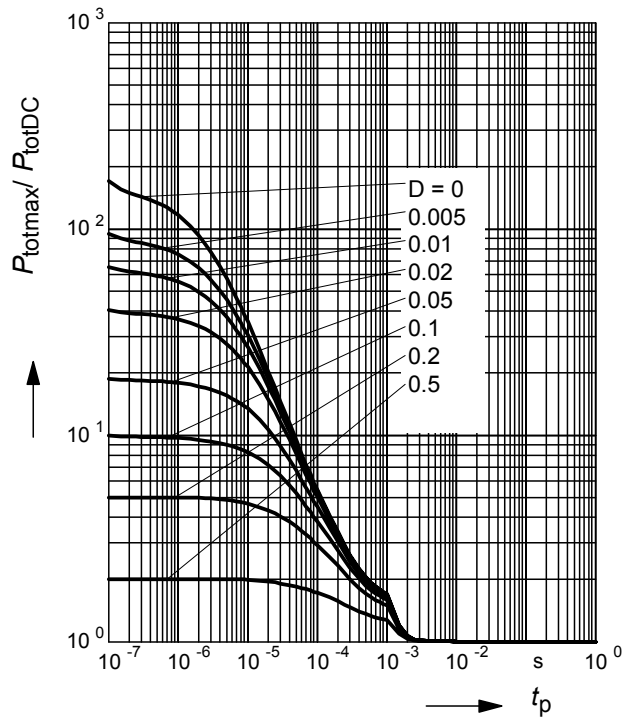

Permissible Puls Load $R_{thJS} = f(t_p)$

BCR192T

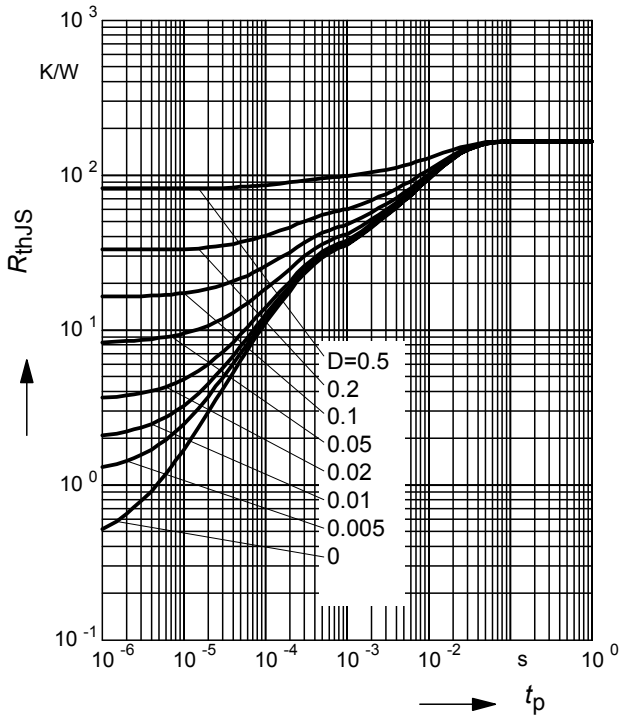

Permissible Pulse Load

$P_{totmax}/P_{totDC} = f(t_p)$

BCR192T

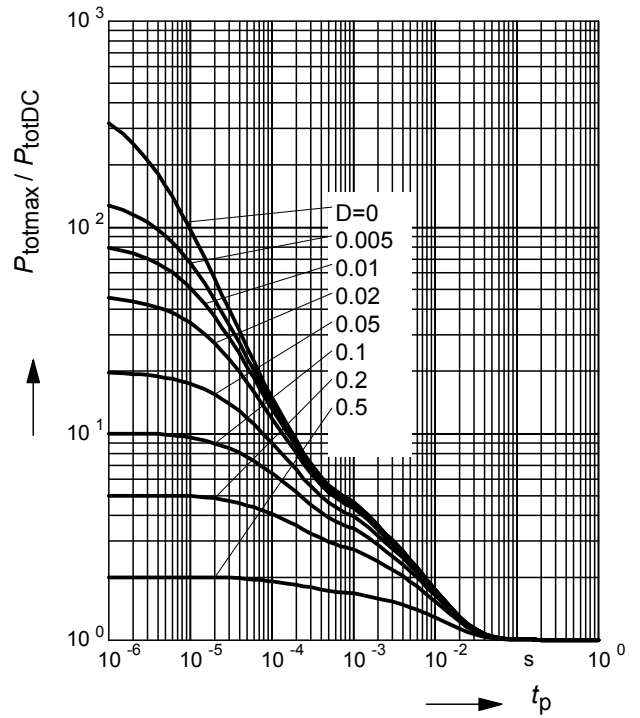

Permissible Puls Load $R_{thJS} = f(t_p)$

BCR192U

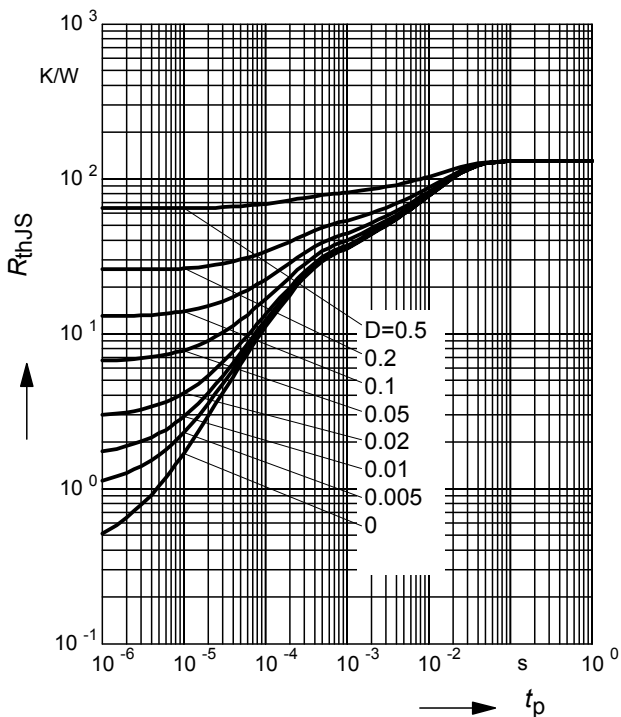

Permissible Pulse Load

$P_{totmax}/P_{totDC} = f(t_p)$

BCR192U

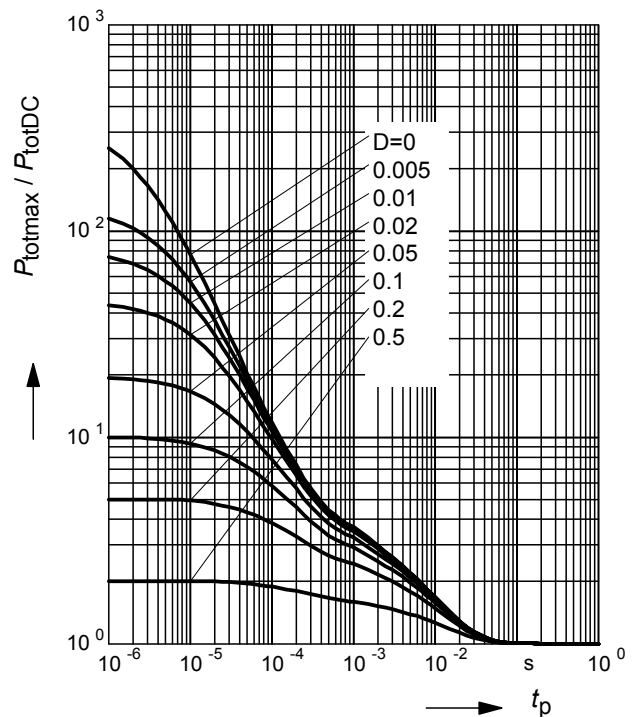

Permissible Puls Load $R_{thJS} = f(t_p)$

BCR192W

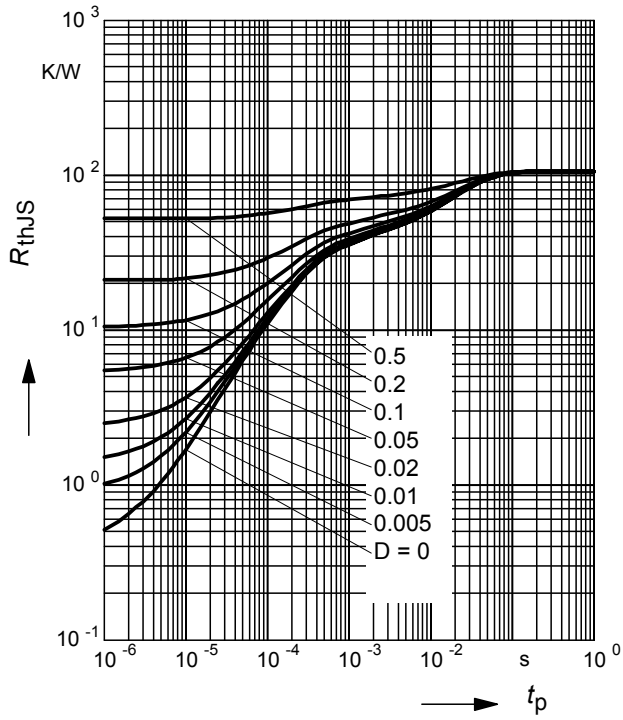

Permissible Pulse Load

$P_{totmax}/P_{totDC} = f(t_p)$

BCR192W

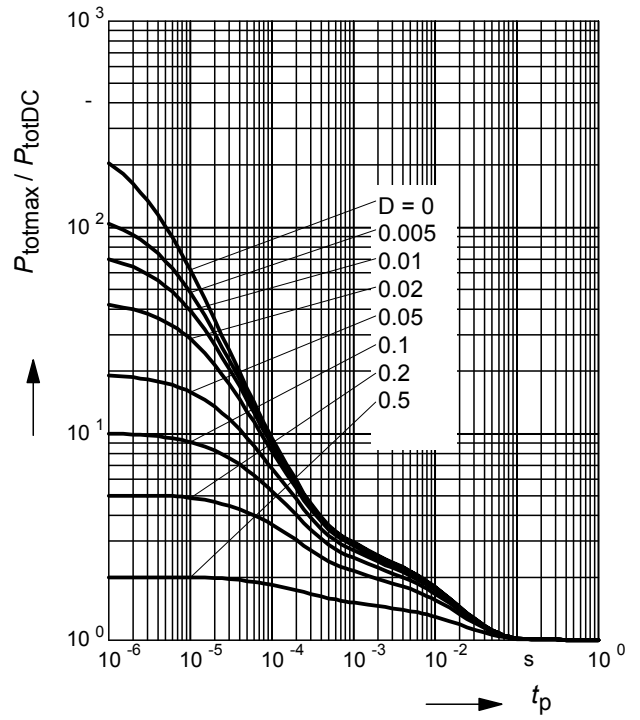

Package Outline

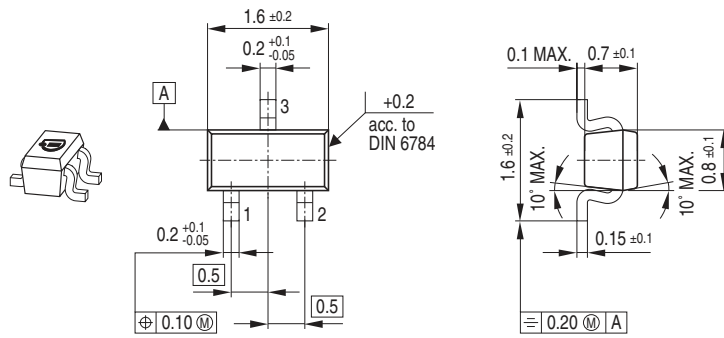

Foot Print

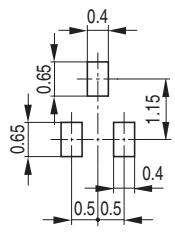

Marking Layout

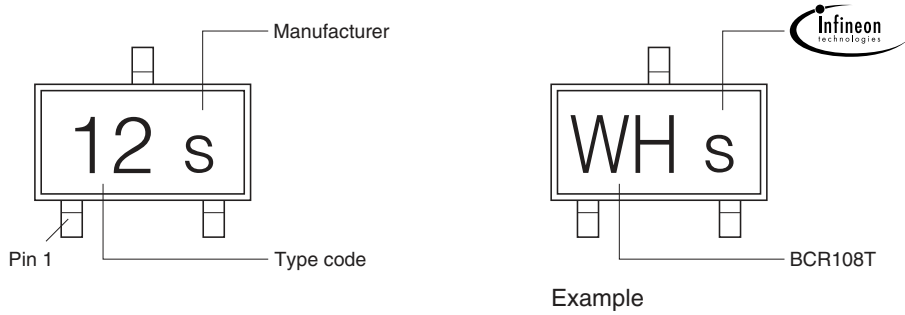

Packing

Code E6327: Reel \varnothing 180 mm = 3.000 Pieces/Reel
 Code E6433: Reel \varnothing 330 mm = 10.000 Pieces/Reel

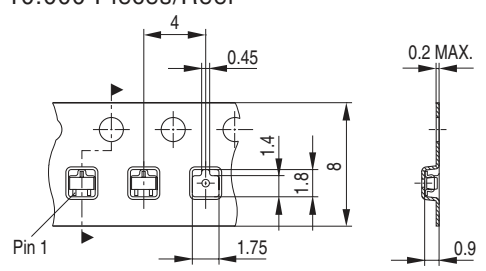

Package Outline

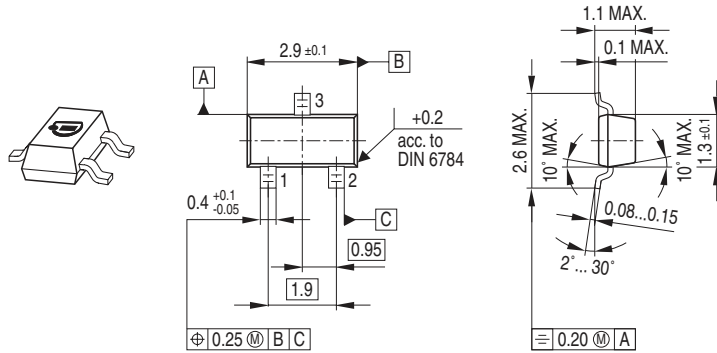

Foot Print

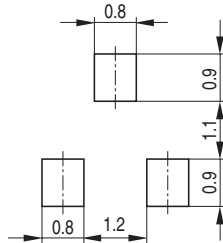

Marking Layout

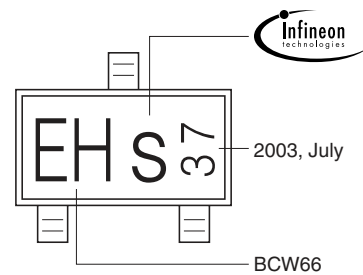
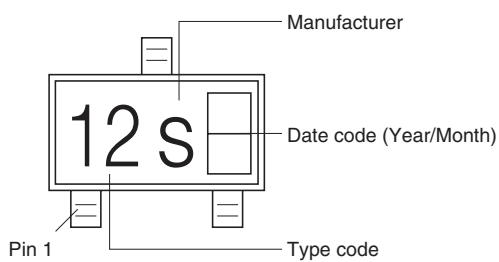

Example

Packing

Code E6327: Reel \varnothing 180 mm = 3.000 Pieces/Reel

Code E6433: Reel \varnothing 330 mm = 10.000 Pieces/Reel

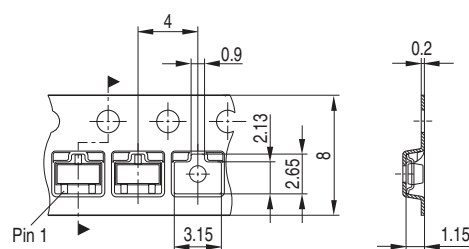

Package Outline

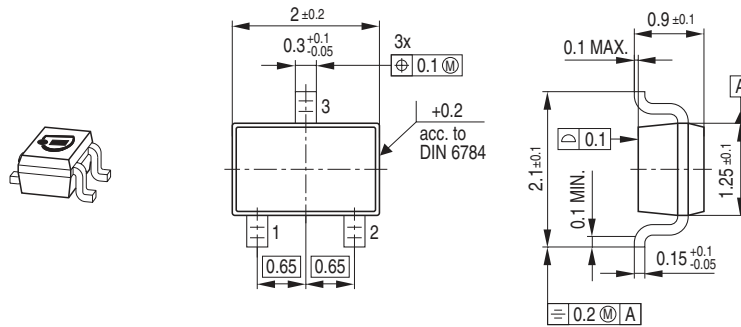

Foot Print

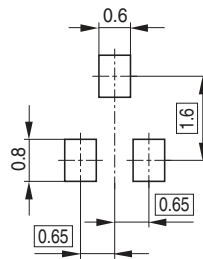

Marking Layout

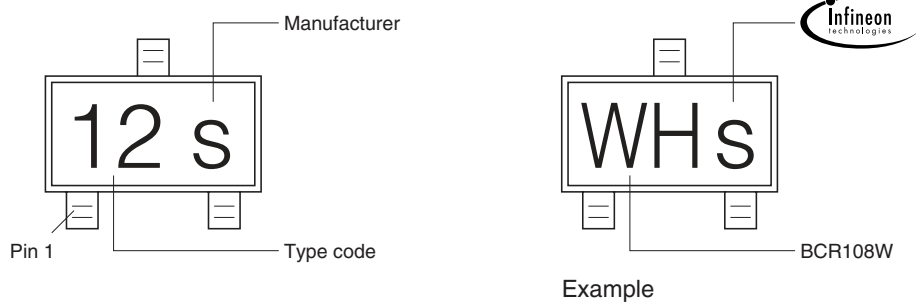

Packing

Code E6327: Reel ø180 mm = 3.000 Pieces/Reel
 Code E6433: Reel ø330 mm = 10.000 Pieces/Reel

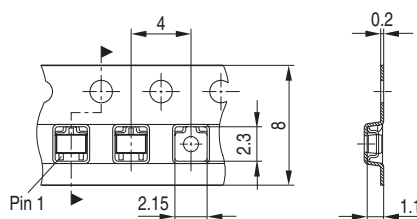

Package Outline

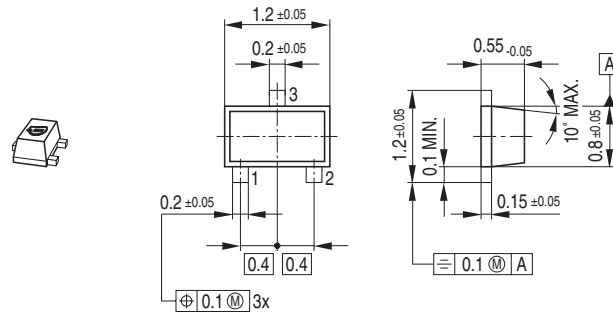

Foot Print

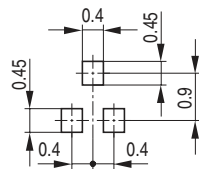

Marking Layout

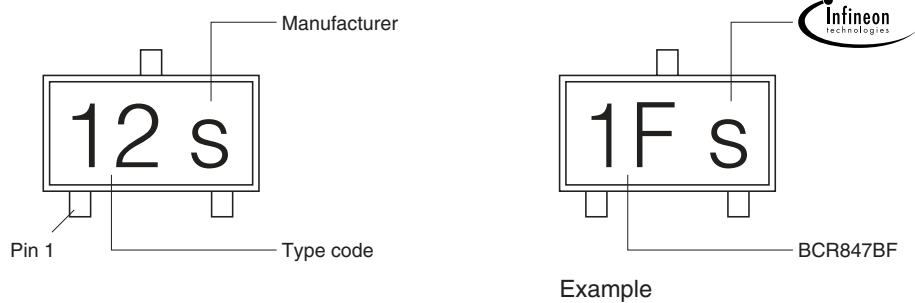

Packing

Code E6327: Reel $\phi 180$ mm = 3.000 Pieces/Reel
 Code E6433: Reel $\phi 330$ mm = 10.000 Pieces/Reel

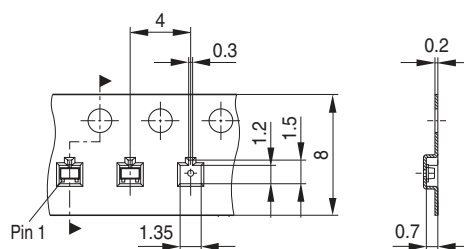

Package Outline

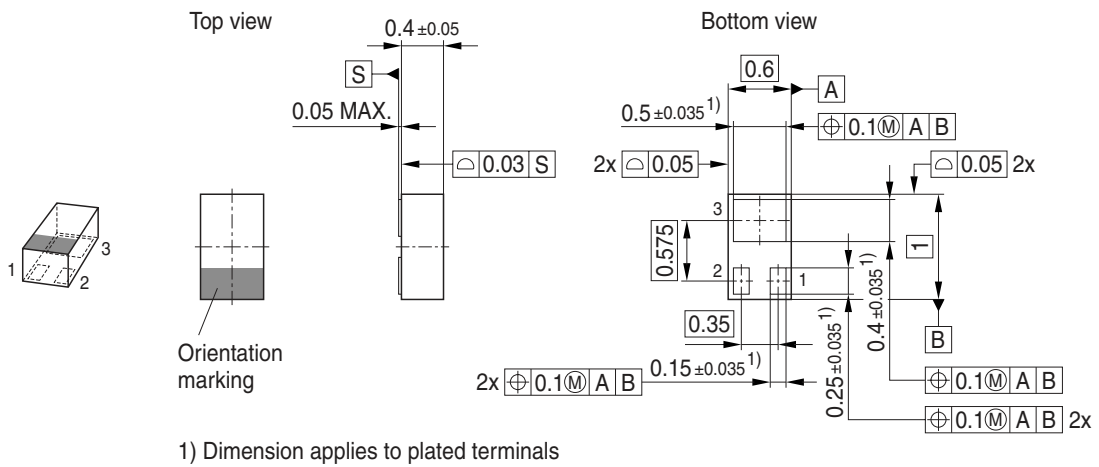

Foot Print

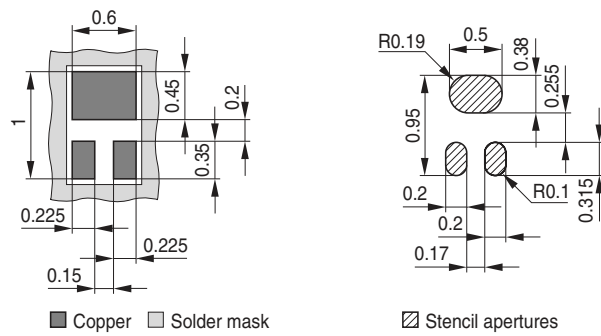

Marking Layout

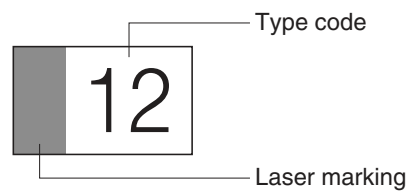

Packing

Code E6327: Reel $\phi 180$ mm = 15.000 Pieces/Reel

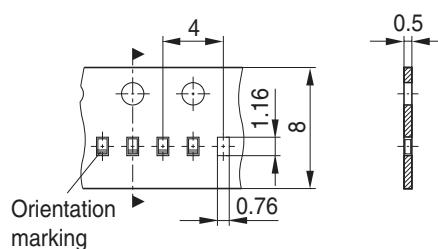

Published by Infineon Technologies AG,
St.-Martin-Strasse 53,
81669 München
© Infineon Technologies AG 2005.
All Rights Reserved.

Attention please!

The information herein is given to describe certain components and shall not be considered as a guarantee of characteristics.

Terms of delivery and rights to technical change reserved.

We hereby disclaim any and all warranties, including but not limited to warranties of non-infringement, regarding circuits, descriptions and charts stated herein.

Information

For further information on technology, delivery terms and conditions and prices please contact your nearest Infineon Technologies Office (www.infineon.com).

Warnings

Due to technical requirements components may contain dangerous substances. For information on the types in question please contact your nearest Infineon Technologies Office.

Infineon Technologies Components may only be used in life-support devices or systems with the express written approval of Infineon Technologies, if a failure of such components can reasonably be expected to cause the failure of that life-support device or system, or to affect the safety or effectiveness of that device or system. Life support devices or systems are intended to be implanted in the human body, or to support and/or maintain and sustain and/or protect human life. If they fail, it is reasonable to assume that the health of the user or other persons may be endangered.